

(12) INTERNATIONAL APPLICATION PUBLISHED UNDER THE PATENT COOPERATION TREATY (PCT)

(19) World Intellectual Property Organization  
International Bureau



(43) International Publication Date  
1 May 2003 (01.05.2003)

PCT

(10) International Publication Number  
WO 03/035829 A2

- (51) International Patent Classification<sup>7</sup>: C12N Chad, A. [US/US]; 111 16th Street, Wilmette, IL 60091 (US).
- (21) International Application Number: PCT/US02/32088
- (22) International Filing Date: 8 October 2002 (08.10.2002)
- (25) Filing Language: English
- (26) Publication Language: English
- (30) Priority Data:  
60/327,864 9 October 2001 (09.10.2001) US  
10/008,978 7 December 2001 (07.12.2001) US
- (63) Related by continuation (CON) or continuation-in-part (CIP) to earlier application:  
US 10/008,978 (CIP)  
Filed on 7 December 2001 (07.12.2001)
- (71) Applicant (for all designated States except US): NANOSPHERE, INC. [US/US]; 1818 Skokie Boulevard, Northbrook, IL 60062 (US).
- (72) Inventors; and
- (75) Inventors/Applicants (for US only): PARK, So-Jung [KR/US]; Apt. #204, 3600 North Hills Drive, Austin, TX 78731 (US). TATON, Thomas, A. [US/US]; 2389 Greenbrier Circle, Little Canada, MN 55117 (US). MIRKIN,
- (74) Agent: MIAO, Emily; McDonnell Boehnen Hulbert & Berghoff, Suite 3200, 300 South Wacker Drive, Chicago, IL 60606 (US).
- (81) Designated States (national): AE, AG, AL, AM, AT, AU, AZ, BA, BB, BG, BR, BY, BZ, CA, CH, CN, CO, CR, CU, CZ, DE, DK, DM, DZ, EC, EE, ES, FI, GB, GD, GE, GH, GM, HR, HU, ID, IL, IN, IS, JP, KE, KG, KP, KR, KZ, LC, LK, LR, LS, LT, LU, LV, MA, MD, MG, MK, MN, MW, MX, MZ, NO, NZ, OM, PH, PL, PT, RO, RU, SD, SE, SG, SI, SK, SL, TJ, TM, TN, TR, TT, TZ, UA, UG, US, UZ, VN, YU, ZA, ZM, ZW.
- (84) Designated States (regional): ARIPO patent (GH, GM, KE, LS, MW, MZ, SD, SL, SZ, TZ, UG, ZM, ZW), Eurasian patent (AM, AZ, BY, KG, KZ, MD, RU, TJ, TM), European patent (AT, BE, BG, CH, CY, CZ, DE, DK, EE, ES, FI, FR, GB, GR, IE, IT, LU, MC, NL, PT, SE, SK, TR), OAPI patent (BF, BJ, CF, CG, CI, CM, GA, GN, GQ, GW, ML, MR, NE, SN, TD, TG).
- Published:  
— without international search report and to be republished upon receipt of that report
- For two-letter codes and other abbreviations, refer to the "Guidance Notes on Codes and Abbreviations" appearing at the beginning of each regular issue of the PCT Gazette.

BEST AVAILABLE COPY

WO 03/035829 A2

(54) Title: NANOPARTICLES HAVING OLIGONUCLEOTIDES ATTACHED THERETO AND USES THEREFOR

(57) Abstract: The invention provides methods of detecting a nucleic acid. The methods comprise contacting the nucleic acid with one or more types of particles having oligonucleotides attached thereto. In one embodiment of the method, the oligonucleotides are attached to nanoparticles and have sequences complementary to portions of the sequence of the nucleic acid. A detectable change (preferably a color change) is brought about as a result of the hybridization of the oligonucleotides on the nanoparticles to the nucleic acid. The invention also provides compositions and kits comprising particles. The invention further provides methods of synthesizing unique nanoparticle-oligonucleotide conjugates, the conjugates produced by the methods, and methods of using the conjugates. In addition, the invention provides nanomaterials and nanostructures comprising nanoparticles and methods of nanofabrication utilizing nanoparticles. Finally, the invention provides a method of separating a selected nucleic acid from other nucleic acids.

**NANOPARTICLES HAVING OLIGONUCLEOTIDES  
ATTACHED THERETO AND USES THEREFOR**

5

This invention was made with government support under National Institutes Of Health (NIH) grant GM10265, Army Research Office (ARO) grant DAAG55-0967-1-0133, AFSOR (DURINT), and DARPA (BAA 01-07). The government has certain rights in the invention.

10

This application is a continuation-in-part of pending application number 10/008,978, filed December 7, 2001, which is a continuation-in-part of 09/927,777, filed August 10, 2001, which is a continuation-in-part of 09/820,279, filed March 28, 2001 which is a continuation-in-part of application number 09/760,500, filed January 12, 2001, which is a continuation-in-part of 09/603,830, filed June 26, 2000, which is

15

a continuation-in-part of application number 09/344,667, filed June 25, 1999 (now U.S. Patent No. 6,361,944), which was a continuation-in-part of application number 09/240,755, filed January 29, 1999 (abandoned), which was a continuation-in-part of pending International application PCT/US97/12783, which was filed July 21, 1997, which are incorporated by reference. Benefit of provisional applications nos.

20

60/031,809, filed July 29, 1996; 60/176,409, filed January 13, 2000; 60/192699, filed March 28, 2000; 60/200,161, filed April 26, 2000; 60/213,906, filed June 26, 2000; 60/224,631, filed August 11, 2000; 60/254,392, filed December 8, 2000; 60/254,418, filed December 8, 2000; 60/255,235, filed December 11, 2000; 60/255,236, filed December 11, 2000; 60/282,640, filed April 9, 2001, and 60/327,864, filed October 8,

25

2001 is also claimed, the disclosures are incorporated by reference.

FIELD OF THE INVENTION

The invention relates to methods of detecting analytes, including nucleic acids and proteins, whether natural or synthetic, and whether modified or unmodified. The invention also relates to materials for detecting analytes, including nucleic acids and proteins, and methods of making those materials. The invention further relates to

30

methods of nanofabrication. Finally, the invention relates to methods of separating a selected nucleic acid from other nucleic acids.

#### BACKGROUND OF THE INVENTION

5           The development of methods for detecting and sequencing nucleic acids is critical to the diagnosis of genetic, bacterial, and viral diseases. *See* Mansfield, E.S. et al. *Molecular and Cellular Probes*, 9, 145-156 (1995). At present, there are a variety of methods used for detecting specific nucleic acid sequences. *Id.* However, these methods are complicated, time-consuming and/or require the use of specialized and  
10           expensive equipment. A simple, fast method of detecting nucleic acids which does not require the use of such equipment would clearly be desirable.

          Colloidal gold-protein probes have found wide applications in immunocytochemistry [S. Garzon and M. Bendayan, "Colloidal Gold Probe: An Overview of its Applications in Viral Cytochemistry," in "Immuno-Gold Electron  
15           Microscopy," Ed. A. D. Hyatt and B. T. Eaton, CrC Press, Ann Arbor, MI (1993); J. E. Beesley, *Colloidal Gold: A New Perspective for Cytochemical marking*, Oxford University Press, Oxford, (1989)]. These probes have been prepared by adsorbing the antibodies onto the gold surface from an aqueous solution under carefully defined conditions. The complexes produced in this manner are functional but suffer from  
20           several drawbacks: e.g., some of the protein desorbs on standing, liberating antibody into solution that competes with adsorbed antibodies for the antigen target; the activity is low since the amount adsorbed is low and some of the antibody denatures on adsorption; and the protein-coated particles are prone to self aggregation, especially in solutions of high ionic strength. An alternative means for preparing  
25           nanoparticle-protein probes has been described by J. E. Hainfeld, R. D. Leone, F. R. Furuya, and R. D. Powell (U.S. Patent 5,521,289, May 28, 1996, "Small Organometallic Probes"). Typically, this procedure involves reduction of a gold salt in an organic solvent containing a triarylphosphine or mercapto-alkyl derivative bearing a reactive substituent, X, to give small nanoparticles (50-70 gold atoms)  
30           carrying X substituents on linkers bound to the surface through Au-P or Au-S bonds. Subsequently the colloidal solution is treated with a protein bearing a substituent Y

that reacts with X to link the protein covalently to the nanoparticle. Work with these nanoparticle is limited by the poor water solubility of many proteins, which limits the range of protein-nanoparticle conjugates that can be utilized effectively. Also, since there are only a few gold atoms at the surface of these particles, the number of  
5 "capture" strands that can be bound to the surface of a given particle is very low.

A variety of methods have been developed for assembling metal and semiconductor colloids into nanomaterials. These methods have focused on the use of covalent linker molecules that possess functionalities at opposing ends with chemical affinities for the colloids of interest. One of the most successful approaches  
10 to date, Brust et al., *Adv. Mater.*, **7**, 795-797 (1995), involves the use of gold colloids and well-established thiol adsorption chemistry, Bain & Whitesides, *Angew. Chem. Int. Ed. Engl.*, **28**, 506-512 (1989) and Dubois & Nuzzo, *Annu. Rev. Phys. Chem.*, **43**, 437-464 (1992). In this approach, linear alkanedithiols are used as the particle linker molecules. The thiol groups at each end of the linker molecule covalently attach  
15 themselves to the colloidal particles to form aggregate structures. The drawbacks of this method are that the process is difficult to control and the assemblies are formed irreversibly. Methods for systematically controlling the assembly process are needed if the materials properties of these structures are to be exploited fully.

The potential utility of DNA for the preparation of biomaterials and in  
20 nanofabrication methods has been recognized. In this work, researchers have focused on using the sequence-specific molecular recognition properties of oligonucleotides to design impressive structures with well-defined geometric shapes and sizes. Shekhtman et al., *New J. Chem.*, **17**, 757-763 (1993); Shaw & Wang, *Science*, **260**, 533-536 (1993); Chen et al., *J. Am Chem. Soc.*, **111**, 6402-6407 (1989); Chen &  
25 Seeman, *Nature*, **350**, 631-633 (1991); Smith and Feigon, *Nature*, **356**, 164-168 (1992); Wang et al., *Biochem.*, **32**, 1899-1904 (1993); Chen et al., *Biochem.*, **33**, 13540-13546 (1994); Marsh et al., *Nucleic Acids Res.*, **23**, 696-700 (1995); Mirkin, *Annu. Review Biophys. Biomol. Struct.*, **23**, 541-576 (1994); Wells, *J. Biol. Chem.*, **263**, 1095-1098 (1988); Wang et al., *Biochem.*, **30**, 5667-5674 (1991). However, the  
30 theory of producing DNA structures is well ahead of experimental confirmation. Seeman et al., *New J. Chem.*, **17**, 739-755 (1993).



A major challenge for those working in the area of DNA detection (G. H. Keller, M. M. Manak, *DNA Probes* (Stockton Press, New York, 1989)) involves the development of methods that do not rely on polymerase chain reaction (PCR) or comparable target amplification systems. Besides added cost, methods based on PCR

5 require additional instrumentation, thermocycling, and reagents that are not ideal for point-of-care or field use. Another restrictive requirement of most DNA detection systems, regardless of their need for PCR, is a thermal stringency wash to achieve desired analyte selectivity. In 1997, an oligonucleotide-modified Au nanoparticles were introduced as colorimetric DNA detection probes (R. Elghanian, J. J. Storhoff,

10 R.C. Mucic, R. L. Letsinger, C. A. Mirkin, *Science* **277**, 1078-1081 (1997)). In contrast with other probes, such as fluorophores or radioactive labels, nanoparticles can be used in variety of detection formats that take advantage of their size dependent scattering, catalytic properties, absorption characteristics, and Raman-enhancing properties to develop systems that are substantially more sensitive and selective than

15 their molecular fluorophore counterparts (J. J. Storhoff, R. Elghanian, R. C. Mucic, C. A. Mirkin, R. L. Letsinger, *J. Am. Chem. Soc.* **120**, 1959-1964 (1998); R. A. Reynolds, C. A. Mirkin, R. L. Letsinger, *J. Am. Chem. Soc.* **122**, 3795-3796 (2000); T. A. Taton, C. A. Mirkin, R. L. Letsinger, *Science* **289**, 1757 (2000); T. A. Taton, L. Gang, C. A. Mirkin, *J. Am. Chem. Soc.* **123**, 5164 (2001); L. He *et al.*, *J. Am. Chem.*

20 *Soc.* **122**, 9071 (2000)). Moreover, gold particles that have been heavily functionalized with oligonucleotides exhibit extraordinarily sharp melting profiles that translate into higher target selectivities (Storhoff (1998); Reynolds (2000); Taton (2000)). Despite the extraordinary sensitivity and selectivity of these systems, all rely on thermal stringency washes to differentiate target strands from ones with

25 mismatches. Accordingly, there is a need for DNA detection methods that do not rely on thermal stringency washes to distinguish base mismatches.

### SUMMARY OF THE INVENTION

The invention provides methods of detecting nucleic acids. In one embodiment, the method comprises contacting a nucleic acid with a type of nanoparticles having oligonucleotides attached thereto (nanoparticle-oligonucleotide conjugates). The nucleic acid has at least two portions, and the oligonucleotides on each nanoparticle have a sequence complementary to the sequences of at least two portions of the nucleic acid. The contacting takes place under conditions effective to allow hybridization of the oligonucleotides on the nanoparticles with the nucleic acid. The hybridization of the oligonucleotides on the nanoparticles, with the nucleic acid results in a detectable change.

In another embodiment, the method comprises contacting a nucleic acid with at least two types of nanoparticles having oligonucleotides attached thereto. The oligonucleotides on the first type of nanoparticles have a sequence complementary to a first portion of the sequence of the nucleic acid. The oligonucleotides on the second type of nanoparticles have a sequence complementary to a second portion of the sequence of the nucleic acid. The contacting takes place under conditions effective to allow hybridization of the oligonucleotides on the nanoparticles with the nucleic acid, and a detectable change brought about by this hybridization is observed.

In a further embodiment, the method comprises providing a substrate having a first type of nanoparticles attached thereto. The first type of nanoparticles has oligonucleotides attached thereto, and the oligonucleotides have a sequence complementary to a first portion of the sequence of a nucleic acid. The substrate is contacted with the nucleic acid under conditions effective to allow hybridization of the oligonucleotides on the nanoparticles with the nucleic acid. Then, a second type of nanoparticles having oligonucleotides attached thereto is provided. The oligonucleotides have a sequence complementary to one or more other portions of the sequence of the nucleic acid, and the nucleic acid bound to the substrate is contacted with the second type of nanoparticle-oligonucleotide conjugates under conditions effective to allow hybridization of the oligonucleotides on the second type of nanoparticles with the nucleic acid. A detectable change may be observable at this point. The method may further comprise providing a binding oligonucleotide having

a selected sequence having at least two portions, the first portion being complementary to at least a portion of the sequence of the oligonucleotides on the second type of nanoparticles. The binding oligonucleotide is contacted with the second type of nanoparticle-oligonucleotide conjugates bound to the substrate under conditions effective to allow hybridization of the binding oligonucleotide to the oligonucleotides on the nanoparticles. Then, a third type of nanoparticles having oligonucleotides attached thereto, the oligonucleotides having a sequence complementary to the sequence of a second portion of the binding oligonucleotide, is contacted with the binding oligonucleotide bound to the substrate under conditions effective to allow hybridization of the binding oligonucleotide to the oligonucleotides on the nanoparticles. Finally, the detectable change produced by these hybridizations is observed.

In yet another embodiment, the method comprises contacting a nucleic acid with a substrate having oligonucleotides attached thereto, the oligonucleotides having a sequence complementary to a first portion of the sequence of the nucleic acid. The contacting takes place under conditions effective to allow hybridization of the oligonucleotides on the substrate with the nucleic acid. Then, the nucleic acid bound to the substrate is contacted with a first type of nanoparticles having oligonucleotides attached thereto, the oligonucleotides having a sequence complementary to a second portion of the sequence of the nucleic acid. The contacting takes place under conditions effective to allow hybridization of the oligonucleotides on the nanoparticles with the nucleic acid. Next, the first type of nanoparticle-oligonucleotide conjugates bound to the substrate is contacted with a second type of nanoparticles having oligonucleotides attached thereto, the oligonucleotides on the second type of nanoparticles having a sequence complementary to at least a portion of the sequence of the oligonucleotides on the first type of nanoparticles, the contacting taking place under conditions effective to allow hybridization of the oligonucleotides on the first and second types of nanoparticles. Finally, a detectable change produced by these hybridizations is observed.

In another embodiment, the method comprises contacting a nucleic acid with a substrate having oligonucleotides attached thereto, the oligonucleotides having a

sequence complementary to a first portion of the sequence of the nucleic acid. The contacting takes place under conditions effective to allow hybridization of the oligonucleotides on the substrate with the nucleic acid. Then, the nucleic acid bound to the substrate is contacted with liposomes having oligonucleotides attached thereto, the oligonucleotides having a sequence complementary to a portion of the sequence of the nucleic acid. This contacting takes place under conditions effective to allow hybridization of the oligonucleotides on the liposomes with the nucleic acid. Next, the liposome-oligonucleotide conjugates bound to the substrate are contacted with a first type of nanoparticles having at least a first type of oligonucleotides attached thereto. The first type of oligonucleotides have a hydrophobic group attached to the end not attached to the nanoparticles, and the contacting takes place under conditions effective to allow attachment of the oligonucleotides on the nanoparticles to the liposomes as a result of hydrophobic interactions. A detectable change may be observable at this point. The method may further comprise contacting the first type of nanoparticle-oligonucleotide conjugates bound to the liposomes with a second type of nanoparticles having oligonucleotides attached thereto. The first type of nanoparticles have a second type of oligonucleotides attached thereto which have a sequence complementary to at least a portion of the sequence of the oligonucleotides on the second type of nanoparticles, and the oligonucleotides on the second type of nanoparticles having a sequence complementary to at least a portion of the sequence of the second type of oligonucleotides on the first type of nanoparticles. The contacting takes place under conditions effective to allow hybridization of the oligonucleotides on the first and second types of nanoparticles. Then, a detectable change is observed.

In another embodiment, the method comprises contacting a nucleic acid to be detected with a substrate having oligonucleotides attached thereto. The oligonucleotides have a sequence complementary to a first portion of the sequence of said nucleic acid, the contacting takes place under conditions effective to allow hybridization of the oligonucleotides on the substrate with said nucleic acid. Next, said nucleic acid bound to the substrate is contacted with a type of nanoparticles having oligonucleotides attached thereto. The oligonucleotides have a sequence

complementary to a second portion of the sequence of said nucleic acid. The contacting takes place under conditions effective to allow hybridization of the oligonucleotides on the nanoparticles with said nucleic acid. Then, the substrate is contacted with silver stain to produce a detectable change, and the detectable change is observed.

5 In yet another embodiment, the method comprises providing a substrate having a first type of nanoparticles attached thereto. The nanoparticles have oligonucleotides attached thereto, the oligonucleotides having a sequence complementary to a first portion of the sequence of a nucleic acid to be detected.

10 Then, the nucleic acid is contacted with the nanoparticles attached to the substrate under conditions effective to allow hybridization of the oligonucleotides on the nanoparticles with said nucleic acid. Next, an aggregate probe comprising at least two types of nanoparticles having oligonucleotides attached thereto is provided. The nanoparticles of the aggregate probe are bound to each other as a result of the

15 hybridization of some of the oligonucleotides attached to them. At least one of the types of nanoparticles of the aggregate probe have oligonucleotides attached thereto which have a sequence complementary to a second portion of the sequence of said nucleic acid. Finally, said nucleic acid bound to the substrate is contacted with the aggregate probe under conditions effective to allow hybridization of the

20 oligonucleotides on the aggregate probe with said nucleic acid, and a detectable change is observed.

In a further embodiment, the method comprises providing a substrate having oligonucleotides attached thereto. The oligonucleotides have a sequence complementary to a first portion of the sequence of a nucleic acid to be detected. An

25 aggregate probe comprising at least two types of nanoparticles having oligonucleotides attached thereto is provided. The nanoparticles of the aggregate probe are bound to each other as a result of the hybridization of some of the oligonucleotides attached to them. At least one of the types of nanoparticles of the aggregate probe have oligonucleotides attached thereto which have a sequence

30 complementary to a second portion of the sequence of said nucleic acid. The nucleic acid, the substrate and the aggregate probe are contacted under conditions effective to

allow hybridization of said nucleic acid with the oligonucleotides on the aggregate probe and with the oligonucleotides on the substrate, and a detectable change is observed.

5 In a further embodiment, the method comprises providing a substrate having oligonucleotides attached thereto. An aggregate probe comprising at least two types of nanoparticles having oligonucleotides attached thereto is provided. The nanoparticles of the aggregate probe are bound to each other as a result of the hybridization of some of the oligonucleotides attached to them. At least one of the types of nanoparticles of the aggregate probe have oligonucleotides attached thereto  
10 which have a sequence complementary to a first portion of the sequence of a nucleic acid to be detected. A type of nanoparticles having at least two types of oligonucleotides attached thereto is provided. The first type of oligonucleotides has a sequence complementary to a second portion of the sequence of said nucleic acid, and the second type of oligonucleotides has a sequence complementary to at least a  
15 portion of the sequence of the oligonucleotides attached to the substrate. The nucleic acid, the aggregate probe, the nanoparticles and the substrate are contacted under conditions effective to allow hybridization of said nucleic acid with the oligonucleotides on the aggregate probe and on the nanoparticles and hybridization of the oligonucleotides on the nanoparticles with the oligonucleotides on the substrate,  
20 and a detectable change is observed.

In another embodiment, the method comprises contacting a nucleic acid to be detected with a substrate having oligonucleotides attached thereto. The oligonucleotides have a sequence complementary to a first portion of the sequence of said nucleic acid. The contacting takes place under conditions effective to allow  
25 hybridization of the oligonucleotides on the substrate with said nucleic acid. The nucleic acid bound to the substrate is contacted with liposomes having oligonucleotides attached thereto, the oligonucleotides having a sequence complementary to a portion of the sequence of said nucleic acid. The contacting takes place under conditions effective to allow hybridization of the oligonucleotides on the  
30 liposomes with said nucleic acid. An aggregate probe comprising at least two types of nanoparticles having oligonucleotides attached thereto is provided. The

nanoparticles of the aggregate probe are bound to each other as a result of the hybridization of some of the oligonucleotides attached to them, at least one of the types of nanoparticles of the aggregate probe having oligonucleotides attached thereto which have a hydrophobic group attached to the end not attached to the nanoparticles.

- 5 The liposomes bound to the substrate are contacted with the aggregate probe under conditions effective to allow attachment of the oligonucleotides on the aggregate probe to the liposomes as a result of hydrophobic interactions, and a detectable change is observed.

- In yet another embodiment, the method comprises providing a substrate  
10 having oligonucleotides attached thereto. The oligonucleotides having a sequence complementary to a first portion of the sequence of a nucleic acid to be detected. A core probe comprising at least two types of nanoparticles is provided. Each type of nanoparticles has oligonucleotides attached thereto which are complementary to the oligonucleotides on at least one of the other types of nanoparticles. The nanoparticles  
15 of the aggregate probe are bound to each other as a result of the hybridization of the oligonucleotides attached to them. Next, a type of nanoparticles having two types of oligonucleotides attached thereto is provided. The first type of oligonucleotides has a sequence complementary to a second portion of the sequence of said nucleic acid, and the second type of oligonucleotides has a sequence complementary to a portion of the  
20 sequence of the oligonucleotides attached to at least one of the types of nanoparticles of the core probe. The nucleic acid, the nanoparticles, the substrate and the core probe are contacted under conditions effective to allow hybridization of said nucleic acid with the oligonucleotides on the nanoparticles and with the oligonucleotides on the substrate and to allow hybridization of the oligonucleotides on the nanoparticles  
25 with the oligonucleotides on the core probe, and a detectable change is observed.

- Another embodiment of the method comprises providing a substrate having oligonucleotides attached thereto, the oligonucleotides having a sequence complementary to a first portion of the sequence of a nucleic acid to be detected. A core probe comprising at least two types of nanoparticles is provided. Each type of  
30 nanoparticles has oligonucleotides attached thereto which are complementary to the oligonucleotides on at least one other type of nanoparticles. The nanoparticles of the

aggregate probe are bound to each other as a result of the hybridization of the oligonucleotides attached to them. A type of linking oligonucleotides comprising a sequence complementary to a second portion of the sequence of said nucleic acid and a sequence complementary to a portion of the sequence of the oligonucleotides  
5 attached to at least one of the types of nanoparticles of the core probe is provided. The nucleic acid, the linking oligonucleotides, the substrate and the core probe are contacted under conditions effective to allow hybridization of said nucleic acid with the linking oligonucleotides and with the oligonucleotides on the substrate and to  
10 allow hybridization of the oligonucleotides on the linking oligonucleotides with the oligonucleotides on the core probe, and a detectable change is observed.

In yet another embodiment, the method comprises providing nanoparticles having oligonucleotides attached thereto and providing one or more types of binding oligonucleotides. Each of the binding oligonucleotides has two portions. The sequence of one portion is complementary to the sequence of one of the portions of  
15 the nucleic acid, and the sequence of the other portion is complementary to the sequence of the oligonucleotides on the nanoparticles. The nanoparticle-oligonucleotide conjugates and the binding oligonucleotides are contacted under conditions effective to allow hybridization of the oligonucleotides on the nanoparticles with the binding oligonucleotides. The nucleic acid and the binding  
20 oligonucleotides are contacted under conditions effective to allow hybridization of the binding oligonucleotides with the nucleic acid. Then, a detectable change is observed. The nanoparticle-oligonucleotide conjugates may be contacted with the binding oligonucleotides prior to being contacted with the nucleic acid, or all three may be contacted simultaneously.

25 In another embodiment, the method comprises contacting a nucleic acid with at least two types of particles having oligonucleotides attached thereto. The oligonucleotides on the first type of particles have a sequence complementary to a first portion of the sequence of the nucleic acid and have energy donor molecules on the ends not attached to the particles. The oligonucleotides on the second type of  
30 particles have a sequence complementary to a second portion of the sequence of the nucleic acid and have energy acceptor molecules on the ends not attached to the



particles. The contacting takes place under conditions effective to allow hybridization of the oligonucleotides on the particles with the nucleic acid, and a detectable change brought about by this hybridization is observed. The energy donor and acceptor molecules may be fluorescent molecules.

5           In a further embodiment, the method comprises providing a type of microspheres having oligonucleotides attached thereto. The oligonucleotides have a sequence complementary to a first portion of the sequence of the nucleic acid and are labeled with a fluorescent molecule. A type of nanoparticles having oligonucleotides attached thereto and which produce a detectable change is also provided. These  
10 oligonucleotides have a sequence complementary to a second portion of the sequence of the nucleic acid. The nucleic acid is contacted with the microspheres and the nanoparticles under conditions effective to allow hybridization of the oligonucleotides on the latex microspheres and on the nanoparticles with the nucleic acid. Then, changes in fluorescence, another detectable change, or both are observed.

15           In another embodiment, the method comprises providing a first type of metallic or semiconductor nanoparticles having oligonucleotides attached thereto. The oligonucleotides have a sequence complementary to a first portion of the sequence of the nucleic acid and are labeled with a fluorescent molecule. A second type of metallic or semiconductor nanoparticles having oligonucleotides attached  
20 thereto is also provided. These oligonucleotides have a sequence complementary to a second portion of the sequence of the nucleic acid and are also labeled with a fluorescent molecule. The nucleic acid is contacted with the two types of nanoparticles under conditions effective to allow hybridization of the oligonucleotides on the two types of nanoparticles with the nucleic acid. Then, changes in  
25 fluorescence are observed.

          In a further embodiment, the method comprises providing a type of particle having oligonucleotides attached thereto. The oligonucleotides have a first portion and a second portion, both portions being complementary to portions of the sequence of the nucleic acid. A type of probe oligonucleotides comprising a first portion and a  
30 second portion is also provided. The first portion has a sequence complementary to the first portion of the oligonucleotides attached to the particles, and both portions are

complementary to portions of the sequence of the nucleic acid. The probe oligonucleotides are also labeled with a reporter molecule at one end. Then, the particles and the probe oligonucleotides are contacted under conditions effective to allow for hybridization of the oligonucleotides on the particles with the probe oligonucleotides to produce a satellite probe. Then, the satellite probe is contacted with the nucleic acid under conditions effective to provide for hybridization of the nucleic acid with the probe oligonucleotides. The particles are removed and the reporter molecule detected.

In yet another embodiment of the method of the invention, a nucleic acid is detected by contacting the nucleic acid with a substrate having oligonucleotides attached thereto. The oligonucleotides have a sequence complementary to a first portion of the sequence of the nucleic acid. The oligonucleotides are located between a pair of electrodes located on the substrate. The contacting takes place under conditions effective to allow hybridization of the oligonucleotides on the substrate with the nucleic acid. Then, the nucleic acid bound to the substrate, is contacted with a type of nanoparticles. The nanoparticles are made of a material which can conduct electricity. The nanoparticles will have one or more types of oligonucleotides attached to them, at least one of the types of oligonucleotides having a sequence complementary to a second portion of the sequence of the nucleic acid. The contacting takes place under conditions effective to allow hybridization of the oligonucleotides on the nanoparticles with the nucleic acid. If the nucleic acid is present, a change in conductivity can be detected. In a preferred embodiment, the substrate will have a plurality of pairs of electrodes located on it in an array to allow for the detection of multiple portions of a single nucleic acid, the detection of multiple different nucleic acids, or both. Each of the pairs of electrodes in the array will have a type of oligonucleotides attached to the substrate between the two electrodes.

The invention further provides a method of detecting a nucleic acid wherein the method is performed on a substrate. The method comprises detecting the presence, quantity or both, of the nucleic acid with an optical scanner.

The invention further provides kits for detecting nucleic acids. In one embodiment, the kit comprises at least one container, the container holding at least

two types of nanoparticles having oligonucleotides attached thereto. The oligonucleotides on the first type of nanoparticles have a sequence complementary to the sequence of a first portion of a nucleic acid. The oligonucleotides on the second type of nanoparticles have a sequence complementary to the sequence of a second portion of the nucleic acid.

Alternatively, the kit may comprise at least two containers. The first container holds nanoparticles having oligonucleotides attached thereto which have a sequence complementary to the sequence of a first portion of a nucleic acid. The second container holds nanoparticles having oligonucleotides attached thereto which have a sequence complementary to the sequence of a second portion of the nucleic acid.

In a further embodiment, the kit comprises at least one container. The container holds metallic or semiconductor nanoparticles having oligonucleotides attached thereto. The oligonucleotides have a sequence complementary to portion of a nucleic acid and have fluorescent molecules attached to the ends of the oligonucleotides not attached to the nanoparticles.

In yet another embodiment, the kit comprises a substrate, the substrate having attached thereto nanoparticles, the nanoparticles having oligonucleotides attached thereto which have a sequence complementary to the sequence of a first portion of a nucleic acid. The kit also includes a first container holding nanoparticles having oligonucleotides attached thereto which have a sequence complementary to the sequence of a second portion of the nucleic acid. The kit further includes a second container holding a binding oligonucleotide having a selected sequence having at least two portions, the first portion being complementary to at least a portion of the sequence of the oligonucleotides on the nanoparticles in the first container. The kit also includes a third container holding nanoparticles having oligonucleotides attached thereto, the oligonucleotides having a sequence complementary to the sequence of a second portion of the binding oligonucleotide.

In another embodiment, the kit comprises a substrate having oligonucleotides attached thereto which have a sequence complementary to the sequence of a first portion of a nucleic acid, a first container holding nanoparticles having oligonucleotides attached thereto which have a sequence complementary to the

sequence of a second portion of the nucleic acid, and a second container holding nanoparticles having oligonucleotides attached thereto which have a sequence complementary to at least a portion of the oligonucleotides attached to the nanoparticles in the first container.

5           In yet another embodiment, the kit comprises a substrate, a first container holding nanoparticles, a second container holding a first type of oligonucleotides having a sequence complementary to the sequence of a first portion of a nucleic acid, a third container holding a second type of oligonucleotides having a sequence  
10           complementary to the sequence of a second portion of the nucleic acid, and a fourth container holding a third type of oligonucleotides having a sequence complementary to at least a portion of the sequence of the second type of oligonucleotides.

          In a further embodiment, the kit comprises a substrate having oligonucleotides attached thereto which have a sequence complementary to the sequence of a first  
15           portion of a nucleic acid. The kit also includes a first container holding liposomes having oligonucleotides attached thereto which have a sequence complementary to the sequence of a second portion of the nucleic acid and a second container holding  
20           nanoparticles having at least a first type of oligonucleotides attached thereto, the first type of oligonucleotides having a hydrophobic group attached to the end not attached to the nanoparticles so that the nanoparticles can be attached to the liposomes by  
25           hydrophobic interactions. The kit may further comprise a third container holding a second type of nanoparticles having oligonucleotides attached thereto, the oligonucleotides having a sequence complementary to at least a portion of the sequence of a second type of oligonucleotides attached to the first type of  
nanoparticles. The second type of oligonucleotides attached to the first type of  
nanoparticles have a sequence complementary to the sequence of the oligonucleotides  
on the second type of nanoparticles.

          In another embodiment, the kit comprises a substrate having nanoparticles attached to it. The nanoparticles have oligonucleotides attached to them which have a  
30           sequence complementary to the sequence of a first portion of a nucleic acid. The kit also includes a first container holding an aggregate probe. The aggregated probe comprises at least two types of nanoparticles having oligonucleotides attached to

5 them. The nanoparticles of the aggregate probe are bound to each other as a result of the hybridization of some of the oligonucleotides attached to each of them. At least one of the types of nanoparticles of the aggregate probe has oligonucleotides attached to it which have a sequence complementary to a second portion of the sequence of the nucleic acid.

10 In yet another embodiment, the kit comprises a substrate having oligonucleotides attached to it. The oligonucleotides have a sequence complementary to the sequence of a first portion of a nucleic acid. The kit further includes a first container holding an aggregate probe. The aggregate probe comprises at least two types of nanoparticles having oligonucleotides attached to them. The nanoparticles of the aggregate probe are bound to each other as a result of the hybridization of some of the oligonucleotides attached to each of them. At least one of the types of nanoparticles of the aggregate probe has oligonucleotides attached thereto which have a sequence complementary to a second portion of the sequence of the nucleic acid.

15 In an additional embodiment, the kit comprises a substrate having oligonucleotides attached to it and a first container holding an aggregate probe. The aggregate probe comprises at least two types of nanoparticles having oligonucleotides attached to them. The nanoparticles of the aggregate probe are bound to each other as a result of the hybridization of some of the oligonucleotides attached to each of them. At least one of the types of nanoparticles of the aggregate probe has oligonucleotides attached to it which have a sequence complementary to a first portion of the sequence of the nucleic acid. The kit also includes a second container holding nanoparticles. The nanoparticles have at least two types of oligonucleotides attached to them. The first type of oligonucleotides has a sequence complementary to a second portion of the sequence of the nucleic acid. The second type of oligonucleotides has a sequence complementary to at least a portion of the sequence of the oligonucleotides attached to the substrate.

25 In another embodiment, the kit comprises a substrate which has oligonucleotides attached to it. The oligonucleotides have a sequence complementary to the sequence of a first portion of a nucleic acid. The kit also comprises a first container holding liposomes having oligonucleotides attached to them. The

oligonucleotides have a sequence complementary to the sequence of a second portion of the nucleic acid. The kit further includes a second container holding an aggregate probe comprising at least two types of nanoparticles having oligonucleotides attached to them. The nanoparticles of the aggregate probe are bound to each other as a result of the hybridization of some of the oligonucleotides attached to each of them. At least one of the types of nanoparticles of the aggregate probe has oligonucleotides attached to it which have a hydrophobic groups attached to the ends not attached to the nanoparticles.

In a further embodiment, the kit may comprise a first container holding nanoparticles having oligonucleotides attached thereto. The kit also includes one or more additional containers, each container holding a binding oligonucleotide. Each binding oligonucleotide has a first portion which has a sequence complementary to at least a portion of the sequence of oligonucleotides on the nanoparticles and a second portion which has a sequence complementary to the sequence of a portion of a nucleic acid to be detected. The sequences of the second portions of the binding oligonucleotides may be different as long as each sequence is complementary to a portion of the sequence of the nucleic acid to be detected. In another embodiment, the kit comprises a container holding one type of nanoparticles having oligonucleotides attached thereto and one or more types of binding oligonucleotides. Each of the types of binding oligonucleotides has a sequence comprising at least two portions. The first portion is complementary to the sequence of the oligonucleotides on the nanoparticles, whereby the binding oligonucleotides are hybridized to the oligonucleotides on the nanoparticles in the container(s). The second portion is complementary to the sequence of a portion of the nucleic acid.

In another embodiment, kits may comprise one or two containers holding two types of particles. The first type of particles having oligonucleotides attached thereto which have a sequence complementary to the sequence of a first portion of a nucleic acid. The oligonucleotides are labeled with an energy donor on the ends not attached to the particles. The second type of particles having oligonucleotides attached thereto which have a sequence complementary to the sequence of a second portion of a nucleic acid. The oligonucleotides are labeled with an energy acceptor on the ends

not attached to the particles. The energy donors and acceptors may be fluorescent molecules.

In a further embodiment, the kit comprises a first container holding nanoparticles having oligonucleotides attached thereto. The kit also includes one or  
5 more additional containers, each container holding binding oligonucleotides. Each binding oligonucleotide has a first portion which has a sequence complementary to at least a portion of the sequence of oligonucleotides on the nanoparticles and a second portion which has a sequence complementary to the sequence of a portion of a nucleic acid to be detected. The sequences of the second portions of the binding  
10 oligonucleotides may be different as long as each sequence is complementary to a portion of the sequence of the nucleic acid to be detected. In yet another embodiment, the kit comprises a container holding one type of nanoparticles having oligonucleotides attached thereto and one or more types of binding oligonucleotides. Each of the types of binding oligonucleotides has a sequence comprising at least two  
15 portions. The first portion is complementary to the sequence of the oligonucleotides on the nanoparticles, whereby the binding oligonucleotides are hybridized to the oligonucleotides on the nanoparticles in the container(s). The second portion is complementary to the sequence of a portion of the nucleic acid.

In another alternative embodiment, the kit comprises at least three containers.  
20 The first container holds nanoparticles. The second container holds a first oligonucleotide having a sequence complementary to the sequence of a first portion of a nucleic acid. The third container holds a second oligonucleotide having a sequence complementary to the sequence of a second portion of the nucleic acid. The kit may further comprise a fourth container holding a binding oligonucleotide having a  
25 selected sequence having at least two portions, the first portion being complementary to at least a portion of the sequence of the second oligonucleotide, and a fifth container holding an oligonucleotide having a sequence complementary to the sequence of a second portion of the binding oligonucleotide.

In another embodiment, the kit comprises one or two containers, the  
30 container(s) holding two types of particles. The first type of particles having oligonucleotides attached thereto that have a sequence complementary to a first

portion of the sequence of a nucleic acid and have energy donor molecules attached to the ends not attached to the nanoparticles. The second type of particles having oligonucleotides attached thereto that have a sequence complementary to a second portion of the sequence of a nucleic acid and have energy acceptor molecules attached to the ends not attached to the nanoparticles. The energy donors and acceptors may be fluorescent molecules.

In a further embodiment, the kit comprises a first container holding a type of microspheres having oligonucleotides attached thereto. The oligonucleotides have a sequence complementary to a first portion of the sequence of a nucleic acid and are labeled with a fluorescent molecule. The kit also comprises a second container holding a type of nanoparticles having oligonucleotides attached thereto. The oligonucleotides have a sequence complementary to a second portion of the sequence of the nucleic acid.

In another embodiment, the kit comprises a first container holding a first type of metallic or semiconductor nanoparticles having oligonucleotides attached thereto. The oligonucleotides have a sequence complementary to a first portion of the sequence of a nucleic acid and are labeled with a fluorescent molecule. The kit also comprises a second container holding a second type of metallic or semiconductor nanoparticles having oligonucleotides attached thereto. These oligonucleotides have a sequence complementary to a second portion of the sequence of a nucleic acid and are labeled with a fluorescent molecule.

In another embodiment, the kit comprises a container holding an aggregate probe. The aggregate probe comprises at least two types of nanoparticles having oligonucleotides attached to them. The nanoparticles of the aggregate probe are bound to each other as a result of the hybridization of some of the oligonucleotides attached to each of them. At least one of the types of nanoparticles of the aggregate probe has oligonucleotides attached to it which have a sequence complementary to a portion of the sequence of a nucleic acid.

In an additional embodiment, the kit comprises a container holding an aggregate probe. The aggregate probe comprises at least two types of nanoparticles having oligonucleotides attached to them. The nanoparticles of the aggregate probe



are bound to each other as a result of the hybridization of some of the oligonucleotides attached to each of them. At least one of the types of nanoparticles of the aggregate probe has oligonucleotides attached to it which have a hydrophobic group attached to the end not attached to the nanoparticles.

5           In a further embodiment, the kit comprises a container holding a satellite probe. The satellite probe comprises a particle having attached thereto oligonucleotides. The oligonucleotides have a first portion and a second portion, both portions having sequences complementary to portions of the sequence of a nucleic acid. The satellite probe also comprises probe oligonucleotides hybridized to the  
10           oligonucleotides attached to the nanoparticles. The probe oligonucleotides have a first portion and a second portion. The first portion has a sequence complementary to the sequence of the first portion of the oligonucleotides attached to the particles, and both portions have sequences complementary to portions of the sequence of the nucleic acid. The probe oligonucleotides also have a reporter molecule attached to  
15           one end.

          In another embodiment, the kit comprising a container holding a core probe, the core probe comprising at least two types of nanoparticles having oligonucleotides attached thereto, the nanoparticles of the core probe being bound to each other as a result of the hybridization of some of the oligonucleotides attached to them.

20           In yet another embodiment, the kit comprises a substrate having attached to it at least one pair of electrodes with oligonucleotides attached to the substrate between the electrodes. The oligonucleotides have a sequence complementary to a first portion of the sequence of a nucleic acid to be detected.

          The invention also provides the satellite probe, an aggregate probe and a core  
25           probe.

          The invention further provides a substrate having nanoparticles attached thereto. The nanoparticles may have oligonucleotides attached thereto which have a sequence complementary to the sequence of a first portion of a nucleic acid.

          The invention also provides a metallic or semiconductor nanoparticle having  
30           oligonucleotides attached thereto. The oligonucleotides are labeled with fluorescent molecules at the ends not attached to the nanoparticle.

The invention further provides a method of nanofabrication. The method comprises providing at least one type of linking oligonucleotide having a selected sequence, the sequence of each type of linking oligonucleotide having at least two portions. The method further comprises providing one or more types of nanoparticles  
5 having oligonucleotides attached thereto, the oligonucleotides on each type of nanoparticles having a sequence complementary to a portion of the sequence of a linking oligonucleotide. The linking oligonucleotides and nanoparticles are contacted under conditions effective to allow hybridization of the oligonucleotides on the nanoparticles to the linking oligonucleotides so that a desired nanomaterials or  
10 nanostructure is formed.

The invention provides another method of nanofabrication. This method comprises providing at least two types of nanoparticles having oligonucleotides attached thereto. The oligonucleotides on the first type of nanoparticles have a sequence complementary to that of the oligonucleotides on the second type of  
15 nanoparticles. The oligonucleotides on the second type of nanoparticles have a sequence complementary to that of the oligonucleotides on the first type of nanoparticle-oligonucleotide conjugates. The first and second types of nanoparticles are contacted under conditions effective to allow hybridization of the oligonucleotides on the nanoparticles to each other so that a desired nanomaterials or nanostructure is  
20 formed.

The invention further provides nanomaterials or nanostructures composed of nanoparticles having oligonucleotides attached thereto, the nanoparticles being held together by oligonucleotide connectors.

The invention also provides a composition comprising at least two types of  
25 nanoparticles having oligonucleotides attached thereto. The oligonucleotides on the first type of nanoparticles have a sequence complementary to the sequence of a first portion of a nucleic acid or a linking oligonucleotide. The oligonucleotides on the second type of nanoparticles have a sequence complementary to the sequence of a second portion of the nucleic acid or linking oligonucleotide.

30 The invention further provides an assembly of containers comprising a first container holding nanoparticles having oligonucleotides attached thereto, and a

second container holding nanoparticles having oligonucleotides attached thereto. The oligonucleotides attached to the nanoparticles in the first container have a sequence complementary to that of the oligonucleotides attached to the nanoparticles in the second container. The oligonucleotides attached to the nanoparticles in the second container have a sequence complementary to that of the oligonucleotides attached to the nanoparticles in the first container.

The invention also provides a nanoparticle having a plurality of different oligonucleotides attached to it.

The invention further provides a method of separating a selected nucleic acid having at least two portions from other nucleic acids. The method comprises providing one or more types of nanoparticles having oligonucleotides attached thereto, the oligonucleotides on each of the types of nanoparticles having a sequence complementary to the sequence of one of the portions of the selected nucleic acid. The selected nucleic acid and other nucleic acids are contacted with the nanoparticles under conditions effective to allow hybridization of the oligonucleotides on the nanoparticles with the selected nucleic acid so that the nanoparticles hybridized to the selected nucleic acid aggregate and precipitate.

In addition, the invention provides methods of making unique nanoparticle-oligonucleotide conjugates. The first such method comprises binding oligonucleotides to charged nanoparticles to produce stable nanoparticle-oligonucleotide conjugates. To do so, oligonucleotides having covalently bound thereto a moiety comprising a functional group which can bind to the nanoparticles are contacted with the nanoparticles in water for a time sufficient to allow at least some of the oligonucleotides to bind to the nanoparticles by means of the functional groups. Next, at least one salt is added to the water to form a salt solution. The ionic strength of the salt solution must be sufficient to overcome at least partially the electrostatic repulsion of the oligonucleotides from each other and, either the electrostatic attraction of the negatively-charged oligonucleotides for positively-charged nanoparticles, or the electrostatic repulsion of the negatively-charged oligonucleotides from negatively-charged nanoparticles. After adding the salt, the oligonucleotides and nanoparticles are incubated in the salt solution for an additional

period of time sufficient to allow sufficient additional oligonucleotides to bind to the nanoparticles to produce the stable nanoparticle-oligonucleotide conjugates. The invention also includes the stable nanoparticle-oligonucleotide conjugates, methods of using the conjugates to detect and separate nucleic acids, kits comprising the  
5 conjugates, methods of nanofabrication using the conjugates, and nanomaterials and nanostructures comprising the conjugates.

The invention provides another method of binding oligonucleotides to nanoparticles to produce nanoparticle-oligonucleotide conjugates. The method comprises providing oligonucleotides, the oligonucleotides comprising a type of  
10 recognition oligonucleotides and a type of diluent oligonucleotides. The oligonucleotides and the nanoparticles are contacted under conditions effective to allow at least some of each of the types of oligonucleotides to bind to the nanoparticles to produce the conjugates. The invention also includes the nanoparticle-oligonucleotide conjugates produced by this method, methods of using the conjugates  
15 to detect and separate nucleic acids, kits comprising the conjugates, methods of nanofabrication using the conjugates, and nanomaterials and nanostructures comprising the conjugates. "Recognition oligonucleotides" are oligonucleotides which comprise a sequence complementary to at least a portion of the sequence of a nucleic acid or oligonucleotide target. "Diluent oligonucleotides" may have any  
20 sequence which does not interfere with the ability of the recognition oligonucleotides to be bound to the nanoparticles or to bind to their targets.

The invention provides yet another method of binding oligonucleotides to nanoparticles to produce nanoparticle-oligonucleotide conjugates. The method comprises providing oligonucleotides, the oligonucleotides comprising at least one  
25 type of recognition oligonucleotides. The recognition oligonucleotides comprise a recognition portion and a spacer portion. The recognition portion of the recognition oligonucleotides has a sequence complementary to at least one portion of the sequence of a nucleic acid or oligonucleotide target. The spacer portion of the recognition oligonucleotide is designed so that it can bind to the nanoparticles. As a  
30 result of the binding of the spacer portion of the recognition oligonucleotide to the nanoparticles, the recognition portion is spaced away from the surface of the

nanoparticles and is more accessible for hybridization with its target. To make the conjugates, the oligonucleotides, including the recognition oligonucleotides, and the nanoparticles are contacted under conditions effective allow at least some of the recognition oligonucleotides to bind to the nanoparticles. The invention also includes  
5 the nanoparticle-oligonucleotide conjugates produced by this method, methods of using the conjugates to detect and separate nucleic acids, kits comprising the conjugates, methods of nanofabrication using the conjugates, and nanomaterials and nanostructures comprising the conjugates.

The invention comprises a method of attaching oligonucleotides to  
10 nanoparticles by means of a linker comprising a cyclic disulfide. Suitable cyclic disulfides have 5 or 6 atoms in their rings, including the two sulfur atoms. Suitable cyclic disulfides are available commercially. The reduced form of the cyclic disulfides can also be used. Preferably, the linker further comprises a hydrocarbon moiety attached to the cyclic disulfide. Suitable hydrocarbons are available  
15 commercially, and are attached to the cyclic disulfides, e.g., as described in the Appendix. Preferably the hydrocarbon moiety is a steroid residue. The linkers are attached to the oligonucleotides and the oligonucleotide-linkers are attached to nanoparticles as described herein.

The present invention also relates to novel nanoparticle probes that exploit  
20 specific binding interactions such as antibody-antigen binding, methods for preparing and using the same, and kits including such probes.

In one embodiment, the invention provides a method for detecting an analyte comprising contacting the analyte with a nanoparticle conjugate having  
oligonucleotides bound thereto. At least a portion of the oligonucleotides attached to  
25 the nanoparticles are bound, as a result of hybridization, to second oligonucleotides having bound thereto a specific binding complement of said analyte. The contacting takes place under conditions effective to allow specific binding interactions between the analyte and specific binding complement bound to the nanoparticle conjugate. A detectable change may be observed as a result of the specific binding interaction  
30 between the analyte and the probe.

In another embodiment of the invention, the method for detecting an analyte comprises providing contacting the analyte with a nanoparticle conjugate having oligonucleotides bound thereto. At least a portion of the oligonucleotides attached to the nanoparticles are bound, as a result of hybridization, to a first portion of a linker oligonucleotide. The second portion of the linker oligonucleotide is bound, as a result of hybridization, to oligonucleotides having bound thereto a specific binding complement of said analyte. The contacting takes place under conditions effective to allow specific binding interaction between the analyte and the nanoparticle conjugate and a detectable change may be observed.

In another embodiment, the method for detecting an analyte comprising providing an analyte having a first oligonucleotide bound thereto, and contacting the oligonucleotide bound to the analyte with a first type of nanoparticles having oligonucleotides bound thereto. The contacting occurs under conditions effective to allow hybridization between the oligonucleotides bound to the analyte with the oligonucleotides attached to the first type of nanoparticles to form a nanoparticle analyte conjugate. The method further comprising contacting the nanoparticle analyte conjugate with a second type of nanoparticle conjugate having oligonucleotides bound thereto. At least a portion of the oligonucleotides bound to the second type of nanoparticle are bound, as a result of hybridization, to oligonucleotides having bound thereto a specific binding complement of said analyte. The oligonucleotide bound to the analyte has a sequence that is complementary to at least a portion of the oligonucleotides bound to the first type of nanoparticles. The contacting takes place under conditions effective to allow specific binding interaction between the analyte and specific binding complement bound to the second type of nanoparticle conjugate and a detectable change may be observed a result of the specific binding interaction.

In yet another embodiment, the method for detecting an analyte comprises providing an analyte having an oligonucleotide bound thereto, a linker oligonucleotide having two portions, and a first type of nanoparticle have oligonucleotides attached thereto. The oligonucleotide bound to the analyte has a sequence that is complementary to the first portion of the sequence of the linker oligonucleotide. At least a portion of the oligonucleotides bound to the first type of

nanoparticles have a sequence that is complementary to a second portion of the linker oligonucleotide. The oligonucleotide bound to the analyte, the oligonucleotide bound to the nanoparticle and the linker oligonucleotide are contacted under conditions effective to allow hybridization between the linker oligonucleotide with the  
5 oligonucleotide bound to the analyte and the oligonucleotides bound to the first type of nanoparticles to form a nanoparticle analyte conjugate. The method further comprises contacting the analyte conjugate with a second type of nanoparticle conjugate having oligonucleotides bound thereto, a least a portion of the oligonucleotides bound to the second type of nanoparticle are bound, as a result of  
10 hybridization, to oligonucleotides having bound thereto a specific binding complement of said analyte. The contacting takes place under conditions effective to allow specific binding interaction between the nanoparticle analyte conjugate and the specific binding complement second type of nanoparticle. A detectable change may be observed as a result of the specific bind interaction.

15 In another embodiment, the method for detecting an analyte comprises providing a support having an analyte bound thereto. The method further comprises contacting the analyte bound to the support to a nanoparticle conjugate having oligonucleotides bound thereto, a least a portion of the oligonucleotides are bound, as a result of hybridization, to second oligonucleotides having bound thereto a specific  
20 binding complement of said analyte. The contacting takes place under conditions effective to allow specific binding interactions between the analyte and specific binding complement bound to the nanoparticle conjugate. A detectable change may be observable at this point.

In another embodiment, the method for detecting an analyte comprises  
25 providing a support having a oligonucleotides bound thereto and an analyte having an oligonucleotide bound thereto, the oligonucleotide bound to the analyte has a sequence that is complementary to the linker oligonucleotides bound to the support. The method further comprises contacting the oligonucleotides bound to the support with the oligonucleotide bound to the analyte under conditions effective to allow  
30 hybridization between the oligonucleotides bound to the support and the oligonucleotides bound to the analytes. Then, a type of nanoparticle conjugate having

oligonucleotides bound thereto is provided. At least a portion of the oligonucleotides bound to the nanoparticle are bound, as a result of hybridization, to second oligonucleotides having bound thereto a specific binding complement of said analyte. Finally, the analyte bound to the support and the specific binding complement bound to the nanoparticle conjugate are contacted under conditions effective to allow for specific binding interactions between the analyte bound to the support and the specific binding complement bound to the nanoparticle, and a detectable change is observed.

5 In yet another embodiment, the method for detecting an analyte comprises providing a support having oligonucleotides bound thereto and a linker oligonucleotide, the sequence of the linker oligonucleotide having at least two portions. The oligonucleotides bound to the support have a sequence that is complementary to the first portion of the linker oligonucleotide. The oligonucleotide bound to the support is then contacted with the linker oligonucleotide under conditions effective to allow hybridization between the oligonucleotides bound to the support with the first portion of the linker oligonucleotide. Next, an analyte having an oligonucleotide bound thereto is provided. The oligonucleotide bound to the analyte has a sequence that is complementary to the second portion of the linker oligonucleotides. The linker oligonucleotide bound to the support is then contacted with the oligonucleotide bound to the analyte under conditions effective to allow hybridization between the oligonucleotide bound to the analyte and the second portion of the linker oligonucleotide. Then, a type of nanoparticle conjugate having oligonucleotides bound thereto is provided. At least a portion of the oligonucleotides bound to the nanoparticle conjugate are bound, as a result of hybridization, to oligonucleotides having bound thereto a specific binding complement of said analyte. The analyte bound to the support is then contacted with the nanoparticle conjugate under conditions effective to allow specific binding interaction between the analyte bound to the support and the specific binding complement bound to the nanoparticle and detectable change is observed.

15 In still yet another embodiment, the method for detecting an analyte comprises contacting a support having oligonucleotides bound thereto with oligonucleotide bound to an analyte, the sequence of the oligonucleotide bound to the analyte is



complementary to the sequence of the oligonucleotides bound to the support. The contacting occurs under conditions effective to allow hybridization between the oligonucleotides bound to the support with the oligonucleotides bound to the analyte. Then, a type of nanoparticle conjugate having oligonucleotides attached thereto is provided. At least a portion of the oligonucleotides attached to the nanoparticle are bound, as a result of hybridization, to a first portion of a linker oligonucleotide. A second portion of the linker oligonucleotide is further bound, as a result of hybridization, to an oligonucleotide having a specific binding complement of said analyte. Next, the analyte bound to the support is then contacted with the nanoparticle conjugate under conditions effective to allow specific binding interactions between the analyte bound to the support and the specific binding complement bound to the nanoparticle. Then, a detectable change is observed.

In another embodiment, the method for detecting an analyte comprises providing a support having an analyte bound thereto. The support is contacted with an aggregate probe comprising at least two types of nanoparticles having oligonucleotides bound thereto. The nanoparticles of the aggregate probe are bound to each other as a result of the hybridization of some of the oligonucleotides attached to them. At least one of the types of nanoparticles of the aggregate probe have oligonucleotides attached thereto which bound, as a result of hybridization, to second oligonucleotides having bound thereto a specific binding complement of said analyte. The contacting takes place under conditions effective to allow specific binding interactions between the analyte bound to the support and specific binding complement bound to the aggregate probe. A detectable change may be observable at this point.

In another embodiment, the method for detecting an analyte comprises contacting a support having oligonucleotides bound thereto with an analyte having an oligonucleotide bound thereto. The oligonucleotide bound to the analyte has a sequence that is complementary to the sequence of the oligonucleotides bound to the support. The contacting occurs under conditions effective to allow hybridization of the oligonucleotides bound to the analyte with the oligonucleotides bound to the

support. Next, an aggregate probe comprising at least two types of nanoparticles having oligonucleotides bound thereto is provided. The nanoparticles of the aggregate probe are bound to each other as a result of the hybridization of some of the oligonucleotides attached to them. At least one of the types of nanoparticles of the aggregate probe have some oligonucleotides attached thereto which are bound, as a result of hybridization, to second oligonucleotides having bound thereto a specific binding complement of said analyte. The contacting takes place under conditions effective to allow specific binding interactions between the analyte bound to the support and specific binding complement bound to the aggregate probe. Then, a detectable change is observed.

In yet another embodiment, the method for detecting an analyte comprises providing contacting a support having a oligonucleotides bound thereto with linker oligonucleotides, the sequence of the second linker oligonucleotide having at least two portions. The contacting occurs under conditions effective to allow hybridization between the oligonucleotides bound to the support and the first portion of the linker oligonucleotide. Then, an analyte having an oligonucleotide bound thereto is provided. The oligonucleotide bound to the analyte has a sequence that is complementary with the second portion of the linker oligonucleotide. Next, the linker oligonucleotide bound to the support is then contacted with the oligonucleotide bound to the analyte under conditions effective to allow hybridization between the second portion of the linker oligonucleotide bound to the support and the oligonucleotide bound to the analyte. Next, an aggregate probe comprising at least two types of nanoparticles having oligonucleotides bound thereto is provided. The nanoparticles of the aggregate probe are bound to each other as a result of the hybridization of some of the oligonucleotides attached to them. At least one of the types of nanoparticles of the aggregate probe have some oligonucleotides attached thereto which bound, as a result of hybridization, to second oligonucleotides having bound thereto a specific binding complement of said analyte. The analyte bound to the support is then contacted with the aggregate probe under conditions effective to allow specific binding interactions between the analyte bound to the support and specific binding complement bound to the aggregate probe. A detectable change may be observable at this point.

In still yet another embodiment, the method for detecting an analyte comprises contacting a support having oligonucleotides bound thereto with an oligonucleotide having analyte bound thereto, the oligonucleotide has a sequence that is complementary to the sequence of the oligonucleotide bound to the support. The contacting occurs under conditions effective to allow hybridization of the oligonucleotides bound to the analyte with the oligonucleotides bound to the support. Next, an aggregate probe comprising at least two types of nanoparticles having oligonucleotides bound thereto is provided. The nanoparticles of the aggregate probe are bound to each other as a result of the hybridization of some of the oligonucleotides attached to them. At least one of the types of nanoparticles of the aggregate probe have some oligonucleotides attached thereto which bound to a first portion of a linker oligonucleotide as a result of hybridization. A second portion of the second linker oligonucleotide is bound, as a result of hybridization, to a oligonucleotide having bound thereto a specific binding complement of said analyte. Then, the analyte bound to the support is contacted with the aggregate probe under conditions effective to allow specific binding interactions between the analyte bound to the support and specific binding complement bound to the aggregate probe. A detectable change is then observed.

In yet another embodiment, the method for detecting an analyte comprises contacting a support having an analyte bound thereto with a nanoparticle conjugate having oligonucleotides bound thereto, at least some of the oligonucleotides attached to the nanoparticle are bound, as a result of hybridization, to second oligonucleotides having bound thereto a specific binding complement of said analyte. The contacting takes place under conditions effective to allow specific binding interactions between the analyte bound to the support and specific binding complement bound to the nanoparticle conjugate. Then, the substrate is contacted with silver stain to produce a detectable change, and the detectable change is observed.

In yet another embodiment of the invention, the method for detecting an analyte comprises contacting a polyvalent analyte with a nanoparticle probe having oligonucleotides bound thereto. At least some of the oligonucleotides attached to the nanoparticle are bound to a first portion of a reporter oligonucleotide as a result of

hybridization. A second portion of the reporter oligonucleotide is bound, as a result of hybridization, to an oligonucleotide having bound thereto a specific binding complement to the analyte. The contacting takes place under conditions effective to allow specific binding interactions between the analyte and the nanoparticle probe and to aggregation of the nanoparticles. Then, the aggregates are isolated and subject to conditions effective to dehybridize the aggregate and to release the reporter oligonucleotide. The reporter oligonucleotide is then isolated. Analyte detection occurs by ascertaining for the presence of reporter oligonucleotide by conventional means such as a DNA chip.

10 The invention also provides a method for detecting a nucleic acid comprising providing (i) a nucleic acid, (ii) one or more types of nanoparticles having oligonucleotides bound thereto, and (iii) a complex comprising streptavidin or avidin bound, by specific binding interaction, to two or more biotin molecules each having oligonucleotides bound thereto. The sequence of the nucleic acid has at least two  
15 portions. The oligonucleotides bound to the nanoparticles have a sequence that is complementary to a first portion of the nucleic acid while the oligonucleotides bound to biotin have a sequence that is complementary to a second portion of the nucleic acid. Then, the nucleic acid is contacted with the nanoparticle conjugate and complex under conditions effective to allow hybridization of the nanoparticles, the complex and the nucleic acid. A detectable change resulting from the subsequent aggregation  
20 is observed.

In another embodiment, a method for detecting a nucleic acid comprising providing (i) a nucleic acid, (ii) one or more types of nanoparticles having oligonucleotides bound thereto, (iii) oligonucleotides have biotin bound thereto; and  
25 (iv) streptavidin or avidin. The sequence of the nucleic acid has at least two portions. The oligonucleotides bound to the nanoparticles have a sequence that is complementary to a first portion of the nucleic acid while the oligonucleotides bound to biotin have a sequence that is complementary to a second portion of the nucleic acid. Then, the nucleic acid is contacted with the nanoparticle conjugate and  
30 oligonucleotide bound to biotin under conditions effective to allow hybridization between the nucleic acid with the oligonucleotides attached to the nanoparticles and

the oligonucleotides attached to the biotin. The resulting biotin complex is then contacted with streptavidin or avidin. A detectable change resulting from the subsequent aggregation is observed.

In another embodiment, the method for detecting a nucleic acid comprises  
5 contacting a first type of nanoparticle having oligonucleotides attached thereto with the nucleic acid. The sequence of the nucleic acid has at least two portions. At least some of the oligonucleotides attached to the nanoparticles have a sequence that is complementary to the first portion of the nucleic acid. The contacting occurs under conditions effective to allow hybridization between the oligonucleotides attached to  
10 the nanoparticle and the first portion of the nucleic acid. Then, an oligonucleotide having a sbp member, e.g., biotin, bound thereto is provided. The sequence of the oligonucleotide bound to the sbp member has a sequence that is complementary to the second portion of the sequence of the nucleic acid. The oligonucleotide bound to the sbp member is then contacted to the nucleic acid bound to the first type of  
15 nanoparticle under conditions effective to allow hybridization between the oligonucleotide bound to the sbp member and the second portion of the nucleic acid. Then, a second type of nanoparticle conjugate having oligonucleotides bound thereto is provided. At least a portion of the oligonucleotides bound to the second type of nanoparticle are bound, as a result of hybridization, to oligonucleotides having bound  
20 thereto a specific binding complement of said analyte (e.g., streptavidin or avidin). The contacting takes place under conditions effective to allow specific binding interaction between the sbp member (e.g., biotin) bound to the first type of nanoparticle and the sbp complement (e.g., streptavidin or avidin) bound to the second type of nanoparticle. A detectable change may result.

25 In another embodiment, the method for detecting a nucleic acid comprises contacting a support having oligonucleotides bound thereto with a nucleic acid, the sequence of the nucleic acid having at least two portions. The oligonucleotides bound to the support have a sequence that is complementary to the first portion of the nucleic acid. The contacting occurs under conditions effective to allow hybridization between  
30 the oligonucleotides bound to the support with the first portion of the nucleic acid. Next, an oligonucleotide having a sbp member (e.g., biotin) bound thereto is

provided. The oligonucleotide bound to the sbp member has a sequence that is complementary to the second portion of the nucleic acid. The nucleic acid bound to the support is then contacted with the oligonucleotide bound to the sbp member under conditions effective to allow hybridization between the oligonucleotide bound to the sbp member and the second portion of the nucleic acid. Then, a type of nanoparticle conjugate having oligonucleotides bound thereto is provided. At least a portion of the oligonucleotides bound to the nanoparticle conjugate are bound, as a result of hybridization, to oligonucleotides having bound thereto a specific binding complement (e.g., streptavidin or avidin) of said sbp member. The sbp member bound to the support is then contacted with the nanoparticle conjugate under conditions effective to allow specific binding interaction between the sbp member bound to the support and the specific binding complement bound to the nanoparticle and a detectable change is observed.

In another embodiment, the method for detecting a nucleic acid comprises contacting a nucleic acid with a nanoparticle conjugate having oligonucleotides attached thereto. The sequence of the nucleic acid has at least two portions. At least some of the oligonucleotides attached to the nanoparticles have a sequence that is complementary to the first portion of the nucleic acid. The contacting occurs under conditions effective to allow hybridization of the oligonucleotides attached to the nanoparticles with the first portion of the nucleic acid. Then, an oligonucleotide having sbp member (e.g., streptavidin) is provided. The oligonucleotide having an sbp member bound thereto has a sequence that is complementary to the second portion of the nucleic acid. The oligonucleotide having the sbp member is then contacted with the nucleic acid bound to the nanoparticle under conditions effective to allow hybridization between the oligonucleotide having the sbp member and the nucleic acid. Next, a support having bound thereto a specific binding complement (e.g., biotin) to the sbp member is provided. The support is then contacted with the sbp member bound to the nanoparticle under conditions effective to allow specific binding interactions to occur between the sbp member and the sb complement bound to the support. A detectable event can be observed.

In another embodiment, the method for detecting a nucleic acid comprises providing contacting the nucleic acid with a support having oligonucleotides bound thereto. The sequence of the nucleic acid has at least two portions and oligonucleotide bound the the support has a sequence that is complementary to the first portion of the nucleic acid. The contacting occurs under conditions effective to allow hybridization between the oligonucleotides bound to the support and the first portion of the nucleic acid. Then, an oligonucleotide having a sbp member (e.g., biotin) bound thereto is provided. The oligonucleotide bound to the sbp member has a sequence that is complementary with the second portion of the nucleic acid. Next, the nucleic acid bound to the support is then contacted with the oligonucleotide bound to the sbp member under conditions effective to allow hybridization between the second portion of the nucleic acid bound to the support and the oligonucleotide bound to the sbp member. Next, an aggregate probe comprising at least two types of nanoparticles having oligonucleotides bound thereto is provided. The nanoparticles of the aggregate probe are bound to each other as a result of the hybridization of some of the oligonucleotides attached to them. At least one of the types of nanoparticles of the aggregate probe have some oligonucleotides attached thereto which bound, as a result of hybridization, to second oligonucleotides having bound thereto a specific binding complement (e.g., streptavidin) of said sbp member. The sbp member bound to the support is then contacted with the aggregate probe under conditions effective to allow specific binding interactions between the sbp member bound to the support and specific binding complement bound to the aggregate probe. A detectable change may be observable at this point.

In another embodiment, the method for detecting a nucleic acid comprises contacting a nucleic acid with an aggregate probe comprising at least two types of nanoparticles having oligonucleotides bound thereto is provided. The nucleic acid has two portions. The nanoparticles of the aggregate probe are bound to each other as a result of the hybridization of some of the oligonucleotides attached to them. At least one of the types of nanoparticles of the aggregate probe have some oligonucleotides attached thereto which bound to a first portion of the nucleic acid as a result of hybridization. Then, an oligonucleotide having sbp member (e.g., streptavidin) is

provided. The oligonucleotide having an sbp member bound thereto has a sequence that is complementary to the second portion of the nucleic acid. The oligonucleotide having the sbp member is then contacted with the nucleic acid bound to the aggregate probe under conditions effective to allow hybridization between the oligonucleotide  
5 having the sbp member and the nucleic acid attached to the probe. Next, a support having bound thereto a specific binding complement (e.g., biotin) to the sbp member is provided. The support is then contacted with the sbp member bound to the aggregate probe under conditions effective to allow specific binding interactions to occur between the sbp member bound to the aggregate probe and the sb complement  
10 bound to the support. A detectable event can be observed.

The invention further provides a nanoparticle-oligonucleotide-sbp member conjugate (nanoparticle sbp conjugate) and compositions containing the same. The nanoparticle sbp conjugate comprise nanoparticles having oligonucleotides bound thereto, at least a portion of the oligonucleotides are hybridized to a first  
15 oligonucleotide having a specific binding pair (sbp) member covalently linked thereto. The oligonucleotides attached to the nanoparticles have at a sequence that is complementary to at least a portion of the first oligonucleotides.

The invention also provides a method for preparing a nanoprobe sbp conjugate comprising providing a nanoparticle conjugate having oligonucleotides bound thereto  
20 and a oligonucleotides having a sbp member bound thereto, and contacting the oligonucleotides attached to the nanoparticle conjugate with the oligonucleotides bound to the sbp member. At least a portion of the oligonucleotides bound to the nanoparticles have a sequence that is complementary to the sequence of the oligonucleotides bound to the sbp member. The contacting occurs under conditions  
25 effective to allow hybridization of the oligonucleotides on the nanoparticles with the first oligonucleotide.

The invention also provides kits for detecting an analyte. In one embodiment, the kit includes at least one container. The container holds nanoparticle sbp conjugates comprising nanoparticles having oligonucleotides bound thereto, at least a  
30 portion of the oligonucleotides are hybridized to a first oligonucleotide having a specific binding pair (sbp) member covalently linked thereto. The oligonucleotides



attached to the nanoparticles have at a sequence that is complementary to at least a portion of the first oligonucleotides. The kit may also include a substrate for observing a detectable change.

5 In another embodiment of the invention, the kit includes at least two containers. The first container includes nanoparticles having oligonucleotides bound thereto. At least a portion of the oligonucleotides have a sequence that is complementary to a portion of a first oligonucleotide. The second container includes first oligonucleotides having an sbp member covalently bound thereto. The kit may also include a substrate for observing a detectable change.

10 In yet another embodiment of the invention, the kit includes at least two containers. The first container includes nanoparticles having oligonucleotides bound thereto. At least a portion of the oligonucleotides have a sequence that is complementary to a portion of a first oligonucleotide. The second container includes first oligonucleotides having a moiety that can be used to covalently link an sbp member. The kit may also include a substrate for observing a detectable change.

15 In yet another embodiment of the invention, the kit includes at least three containers. The first container includes nanoparticles having oligonucleotides bound thereto. The second container contains a linker oligonucleotide having at least two portions. The third container includes first oligonucleotides having a moiety that can be used to covalently link an sbp member. At least a portion of the oligonucleotides have a sequence that is complementary to a first portion of a linker oligonucleotide. The first oligonucleotides have a sequence that is complementary to at least a second portion of the linker oligonucleotides. The kit may also include a substrate for observing a detectable change.

25 The invention further provides a method of nanofabrication. The method comprises providing at least one type of linking oligonucleotide having a selected sequence, the sequence of each type of linking oligonucleotide having at least two portions. The method further comprises providing one or more types of nanoparticles having oligonucleotides attached thereto, the oligonucleotides on each type of nanoparticles having a sequence complementary to a first portion of the sequence of a linking oligonucleotide. The method further comprises providing a complex

comprised of strepavidin or avidin bound to two or more biotin molecules, each having a first oligonucleotide bound thereto, the first oligonucleotide having a sequence complementary to a second portion of the sequence of the linking oligonucleotide. The linking oligonucleotides, complex, and nanoparticles are  
5 contacted under conditions effective to allow hybridization of the oligonucleotides on the nanoparticles and the first oligonucleotides bound to the biotin to the linking oligonucleotides so that a desired nanomaterials or nanostructure is formed.

The invention provides another method of nanofabrication. This method comprises providing (a) at least two types of nanoparticles having oligonucleotides  
10 attached thereto; (b) at least one type of linking oligonucleotide having a selected sequence, the sequence of each type of linking oligonucleotide having at least two portions; and (c) a complex comprised of strepavidin or avidin bound to two or more biotin molecules, each having a first oligonucleotide bound thereto. The oligonucleotides on the first type of nanoparticles have a sequence complementary to  
15 that of the oligonucleotides on the second type of nanoparticles and a sequence that is complementary to the first portion of the sequence of the linking oligonucleotides. The oligonucleotides on the second type of nanoparticles have a sequence complementary to that of the oligonucleotides on the first type of nanoparticle-oligonucleotide conjugates and a sequence that is complementary to the second  
20 portion of the sequence of the linking oligonucleotide. The first and second types of nanoparticles, the linking oligonucleotides, and the complex are contacted under conditions effective to allow hybridization of the oligonucleotides on the nanoparticles to each other and to the linking oligonucleotide and the hybridization of the oligonucleotides of the complexes to the linking oligonucleotides so that a desired  
25 nanomaterials or nanostructure is formed.

The invention further provides yet another method of nanofabrication. The method comprises providing (a) at least one type of linking oligonucleotide having a selected sequence, the sequence of each type of linking oligonucleotide having at least two portions; (b) one or more types of nanoparticles having oligonucleotides attached  
30 thereto, the oligonucleotides on each type of nanoparticles having a sequence complementary to a first portion of the sequence of a linking oligonucleotide; (c)

biotin having a first oligonucleotide bound thereto, the first oligonucleotide having a sequence complementary to a second portion of the sequence of the linking oligonucleotide; and (d) streptavidin or avidin. The linking oligonucleotides, biotin conjugate, and nanoparticles are contacted under conditions effective to allow  
5 hybridization of the oligonucleotides on the nanoparticles and the first oligonucleotides bound to the biotin to the linking oligonucleotides. Then, the resulting complex is contacting with streptavidin or avidin under conditions effective to allow specific binding interaction between biotin and streptavidin or avidin so that a desired nanomaterials or nanostructure is formed.

10 The invention further provides nanomaterials or nanostructures composed of nanoparticles having oligonucleotides attached thereto, the nanoparticles being held together by oligonucleotide connectors and sbp interactions.

The invention further provides a method of separating a selected target nucleic acid having at least two portions from other nucleic acids. The method comprises  
15 providing (a) one or more types of nanoparticles having oligonucleotides attached thereto, the oligonucleotides on each of the types of nanoparticles having a sequence complementary to the sequence of the first portion of the selected nucleic acid; (b) a complex comprised of streptavidin or avidin bound to two or more biotin molecules, each having a first oligonucleotide bound thereto, the first oligonucleotide having a  
20 sequence complementary to the sequence of the second portion of the selected nucleic acid. The selected nucleic acid and other nucleic acids are contacted with the nanoparticles under conditions effective to allow hybridization of the oligonucleotides on the nanoparticles and the first oligonucleotides of the complex with the selected nucleic acid so that the nanoparticles and complex hybridized to the selected nucleic  
25 acid aggregate and precipitate.

The invention further provides a method of separating a selected target nucleic acid having at least two portions from other nucleic acids. The method comprises  
providing (a) one or more types of nanoparticles having oligonucleotides attached thereto, the oligonucleotides on each of the types of nanoparticles having a sequence  
30 complementary to the sequence of the first portion of the selected nucleic acid; (b) biotin having a first oligonucleotide bound thereto, the first oligonucleotide having a

sequence complementary to the sequence of the second portion of the selected nucleic acid; and (c) streptavidin or avidin. The selected nucleic acid and other nucleic acids are contacted with the nanoparticles and biotin construct under conditions effective to allow hybridization of the oligonucleotides on the nanoparticles and the first  
5 oligonucleotides of the biotin construct with the selected nucleic acid. Then, the resulting complex is contacted with streptavidin or avidin under conditions effective to allow specific binding interactions between the biotin and streptavidin or avidin and subsequent aggregation and precipitation of the resulting selected nucleic acid complex.

10 The invention also provides a method to actively move and concentrate nanoparticle probes bound to a biomolecules to and from an electrode surface containing captured target molecules or a set of nanoparticle probes bound to captured target in solution to a surface of interest.

Another object of the invention is to provide a method for accelerating  
15 movement of a nanoparticle to an electrode surface comprising providing a nanoparticle bound to a charged first member of a specific binding pair and an electrode surface including a second member of a specific binding pair; contacting the nanoparticle and the surface under conditions effective to allow binding between the first and the second members of the specific binding pair; and  
20 nanoparticle to an electrical field so as to accelerate movement of the nanoparticle to the surface and facilitate binding between the first and second members of the binding pair. The specific binding pairs include an antibody/antigen and receptor/ligand.

Yet another object of the invention is to provide a method of detecting a  
25 nucleic acid bound to an electrode surface, the nucleic acid having at least two portions, comprising: providing one or more types of nanoparticles having oligonucleotides attached thereto, the oligonucleotides on each of the types of nanoparticles having a sequence complementary to the sequence of one of the portions of the nucleic acid; contacting the nucleic acid and the nanoparticles under  
30 nanoparticles with the nucleic acid; subjecting the nanoparticle to an electrical field so as to accelerate movement of the nanoparticle to the surface; and observing a

detectable change brought about by hybridization of the oligonucleotides on the nanoparticles with the nucleic acid.

Yet another object of the invention is to provide a method of detecting nucleic acid bound to a surface, the nucleic acid having at least two portions comprising:  
5 contacting the nucleic acid with at least two types of nanoparticles having oligonucleotides attached thereto, the oligonucleotides on the first type of nanoparticles having a sequence complementary to a first portion of the sequence of the nucleic acid, the oligonucleotides on the second type of nanoparticles having a sequence complementary to a second portion of the sequence of the nucleic acid, the  
10 contacting taking place under conditions effective to allow hybridization of the oligonucleotides on the nanoparticles with the nucleic acid; subjecting the nanoparticle to an electrical field so as to accelerate movement of the nanoparticle to the surface; and observing a detectable change brought about by hybridization of the oligonucleotides on the nanoparticles with the nucleic acid. Contacting conditions  
15 may include freezing and thawing, and heating. The detectable change may be observed on a solid surface and include a color change observable with the naked eye.

The invention further provides a method for multicolor labeling and imaging of DNA arrays using different sized oligonucleotide-functionalized nanoparticle probes is described. Because different sized (e.g., 50 nm and 100 nm diameter) gold  
20 nanoparticles scatter light of different colors (due to their different surface plasmon resonances), they can be used to label different DNA targets hybridized to the same array. Using an evanescent waveguide technique which only detects particles bound at the array surface and not those suspended in solution above the array, sequence information and melting profiles can be obtained from nanoparticle-labeled arrays in  
25 real time as targets are melted away from array elements with increasing temperature. It was observed that the sequence selectivity of these nanoparticle labeled arrays is significantly higher than that of fluorophore-labeled arrays. The higher selectivity of arrays labeled with nanoparticles is caused by the inherently narrow temperature range for dissociation of the nanoparticle probes from the array surface.

30 In one aspect of the multicolor labeling invention, a method of detecting nucleic acid in a sample, the nucleic acid having at least two portions, is provided.

The method comprises: (a) providing a substrate having oligonucleotides attached thereto, the oligonucleotides having a sequence complementary to a first portion of the sequence of a nucleic acid to be detected; (b) providing a scattered light detectable nanoparticle probe having oligonucleotides attached thereto, the oligonucleotides  
5 bound to the nanoparticle probe having a sequence complementary to a second portion of the sequence of said nucleic acid wherein the oligonucleotides are attached to the nanoparticles in a stepwise ageing process comprising (i) contacting the oligonucleotides with the nanoparticles in a first aqueous solution for a period of time sufficient to allow some of the oligonucleotides to bind to the nanoparticles; (ii)  
10 adding at least one salt to the aqueous solution to create a second aqueous solution; and (iii) contacting the oligonucleotides and nanoparticles in the second aqueous solution for an additional period of time to enable additional oligonucleotides to bind to the nanoparticles; (c) contacting said nucleic acid, the substrate and the aggregate probe under conditions effective to allow hybridization of said nucleic acid with the  
15 oligonucleotides on the nanoparticle probe and with the oligonucleotides on the substrate and form a light scattering complex bound to the substrate; (d) illuminating the light scattering complex under conditions effective to produce scattered light from said complex; and (e) detecting the light scattered by said complex under said conditions as a measure of the presence of the nucleic acid. The substrate is a  
20 waveguide comprising (a) a transparent element having a refractive index greater than that of the fluid sample; (b) a light receiving edge; and (c) a surface having oligonucleotides bound thereto.

In another aspect of the multicolor labeling invention, a method of detecting  
25 two or more nucleic acids in a sample, each nucleic acid having at least two portions, is provided. The method comprises: (a) providing a substrate having two or more types of oligonucleotides attached thereto, each type of oligonucleotides attached to a different place on the substrate and each type of oligonucleotides having sequences complementary to a first portion of the sequences of one of nucleic acids to be  
detected; (b) providing two or more types of scattered light detectable nanoparticle  
30 probes, each type of nanoparticle probes having the oligonucleotides bound thereto, the oligonucleotides bound to each type of probe have a sequence that are

complementary to a second portion of the sequence of one of said nucleic acids to be detected, wherein the oligonucleotides are attached to the nanoparticles in a stepwise ageing process comprising (i) contacting the oligonucleotides with the nanoparticles in a first aqueous solution for a period of time sufficient to allow some of the oligonucleotides to bind to the nanoparticles; (ii) adding at least one salt to the aqueous solution to create a second aqueous solution; and (iii) contacting the oligonucleotides and nanoparticles in the second aqueous solution for an additional period of time to enable additional oligonucleotides to bind to the nanoparticles; (c) contacting said nucleic acids, the substrate and the nanoparticle probes under conditions effective to allow hybridization of said nucleic acids with the oligonucleotides on the nanoparticle probes and with the oligonucleotides on the substrate to form a light scattering complex bound to the substrate; (d) illuminating the light scattering complex under conditions effective to produce scattered light from said complex; and (e) detecting the light scattered by said complex under said conditions as a measure of the presence of one or more nucleic acids. The substrate is a waveguide comprising (a) a transparent element having a refractive index greater than that of the fluid sample; (b) a light receiving edge; and (c) a surface having oligonucleotides bound thereto.

The invention also provides a method for increasing the selectivity of nucleic acid detection by exploiting the salt concentration dependent hybridization behavior of the nanoparticle conjugates of the invention. The unusual salt-dependence of the melting properties of the nanoparticle oligonucleotide conjugates can be used to eliminate thermal stringency washes for mismatch discrimination, a significant step towards the development of a hand-held DNA detection system. Accordingly, in one embodiment of the invention, a method for detecting a nucleic acid is provided. The method comprises providing a substrate having oligonucleotides bound thereto, the oligonucleotides bound to the substrate have a sequence that is complementary to a first portion of a sequence of a nucleic acid; providing labels, such as nanoparticles, having oligonucleotides bound thereto, at least some of the oligonucleotides having a sequence that is complementary to the sequence of a second portion of the nucleic acid; contacting the substrate, nucleic acid, and labels, the contacting taking place

under conditions effective to allow hybridization between the oligonucleotides bound to the substrate with the nucleic acids and between the nucleic acid and the oligonucleotide bound to the label so as to form a test substrate having labels complexed thereto; contacting the test substrate with an aqueous salt solution  
5 having a salt concentration effective to substantially remove non-specifically bound labels; and observing a detectable change.

In another embodiment of the invention, the method for detecting a nucleic acid having at least two portions comprises (a) contacting a nucleic acid with a substrate having oligonucleotides attached thereto, the oligonucleotides being located  
10 between a pair of electrodes, the oligonucleotides having a sequence complementary to a first portion of the sequence of said nucleic acid, the contacting taking place under conditions effective to allow hybridization of the oligonucleotides on the substrate with said nucleic acid; (b) contacting said nucleic acid bound to the substrate with a first type of labels such as nanoparticles, the labels being made of a material  
15 which can conduct electricity, the labels having one or more types of oligonucleotides attached thereto, at least one of the types of oligonucleotides having a sequence complementary to a second portion of the sequence of said nucleic acid, the contacting taking place under conditions effective to allow hybridization of the oligonucleotides on the labels with said nucleic acid so as to form a test substrate  
20 having labels complexed thereto; (c) contacting the test substrate with an aqueous salt solution having a salt concentration effective to sufficiently remove non-specifically bound labels; and (d) detecting a change in an electrical property of the electrodes.

As used herein, a "type of oligonucleotides" refers to a plurality of oligonucleotide molecules having the same sequence. A "type of" nanoparticles,  
25 conjugates, particles, latex microspheres, etc. having oligonucleotides attached thereto refers to a plurality of that item having the same type(s) of oligonucleotides attached to them. "Nanoparticles having oligonucleotides attached thereto" are also sometimes referred to as "nanoparticle-oligonucleotide conjugates" or, in the case of the detection methods of the invention, "nanoparticle-oligonucleotide probes,"  
30 "nanoparticle probes," or just "probes."



The term "analyte" refers to the compound or composition to be detected, including drugs, metabolites, pesticides, pollutants, and the like. . The analyte can be comprised of a member of a specific binding pair (sbp) and may be a ligand, which is monovalent (monoepitopic) or polyvalent (polyepitopic), usually antigenic or  
5 haptenic, and is a single compound or plurality of compounds which share at least one common epitopic or determinant site. The analyte can be a part of a cell such as bacteria or a cell bearing a blood group antigen such as A, B, D, etc., or an HLA antigen or a microorganism, e.g., bacterium, fungus, protozoan, or virus.

The polyvalent ligand analytes will normally be poly(amino acids), i.e.,  
10 polypeptides and proteins, polysaccharides, nucleic acids, and combinations thereof. Such combinations include components of bacteria, viruses, chromosomes, genes, mitochondria, nuclei, cell membranes and the like.

For the most part, the polyepitopic ligand analytes to which the subject invention can be applied will have a molecular weight of at least about 5,000, more  
15 usually at least about 10,000. In the poly(amino acid) category, the poly(amino acids) of interest will generally be from about 5,000 to 5,000,000 molecular weight, more usually from about 20,000 to 1,000,000 molecular weight; among the hormones of interest, the molecular weights will usually range from about 5,000 to 60,000 molecular weight.

20 A wide variety of proteins may be considered as to the family of proteins having similar structural features, proteins having particular biological functions, proteins related to specific microorganisms, particularly disease causing microorganisms, etc. Such proteins include, for example, immunoglobulins, cytokines, enzymes, hormones, cancer antigens, nutritional markers, tissue specific  
25 antigens, etc.

The types of proteins, blood clotting factors, protein hormones, antigenic polysaccharides, microorganisms and other pathogens of interest in the present invention are specifically disclosed in U.S. Pat. No. 4,650,770, the disclosure of which is incorporated by reference herein in its entirety.

30 The monoepitopic ligand analytes will generally be from about 100 to 2,000 molecular weight, more usually from 125 to 1,000 molecular weight.

The analyte may be a molecule found directly in a sample such as a body fluid from a host. The sample can be examined directly or may be pretreated to render the analyte more readily detectible. Furthermore, the analyte of interest may be determined by detecting an agent probative of the analyte of interest such as a specific  
5 binding pair member complementary to the analyte of interest, whose presence will be detected only when the analyte of interest is present in a sample. Thus, the agent probative of the analyte becomes the analyte that is detected in an assay. The body fluid can be, for example, urine, blood, plasma, serum, saliva, semen, stool, sputum, cerebral spinal fluid, tears, mucus, and the like.

10 The term "specific binding pair (sbp) member" refers to one of two different molecules, having an area on the surface or in a cavity which specifically binds to and is thereby defined as complementary with a particular spatial and polar organization of the other molecule. The members of the specific binding pair are referred to as ligand and receptor (antiligand). These will usually be members of an immunological  
15 pair such as antigen-antibody, although other specific binding pairs such as biotin-avidin, hormones-hormone receptors, nucleic acid duplexes, IgG-protein A, polynucleotide pairs such as DNA-DNA, DNA-RNA, and the like are not immunological pairs but are included in the invention and the definition of sbp member.

20 The term "ligand" refers to any organic compound for which a receptor naturally exists or can be prepared. The term ligand also includes ligand analogs, which are modified ligands, usually an organic radical or analyte analog, usually of a molecular weight greater than 100, which can compete with the analogous ligand for a receptor, the modification providing means to join the ligand analog to another  
25 molecule. The ligand analog will usually differ from the ligand by more than replacement of a hydrogen with a bond which links the ligand analog to a hub or label, but need not. The ligand analog can bind to the receptor in a manner similar to the ligand. The analog could be, for example, an antibody directed against the idiotype of an antibody to the ligand.

30 The term "receptor" or "antiligand" refers to any compound or composition capable of recognizing a particular spatial and polar organization of a molecule, e.g.,

epitopic or determinant site. Illustrative receptors include naturally occurring receptors, e.g., thyroxine binding globulin, antibodies, enzymes, Fab fragments, lectins, nucleic acids, avidin, protein A, barstar, complement component C1q, and the like. Avidin is intended to include egg white avidin and biotin binding proteins from  
5 other sources, such as streptavidin.

The term "specific binding" refers to the specific recognition of one of two different molecules for the other compared to substantially less recognition of other molecules. Generally, the molecules have areas on their surfaces or in cavities giving rise to specific recognition between the two molecules. Exemplary of specific binding  
10 are antibody-antigen interactions, enzyme-substrate interactions, polynucleotide interactions, and so forth.

The term "non-specific binding" refers to the non-covalent binding between molecules that is relatively independent of specific surface structures. Non-specific binding may result from several factors including hydrophobic interactions between  
15 molecules.

The term "antibody" refers to an immunoglobulin which specifically binds to and is thereby defined as complementary with a particular spatial and polar organization of another molecule. The antibody can be monoclonal or polyclonal and can be prepared by techniques that are well known in the art such as immunization of  
20 a host and collection of sera (polyclonal) or by preparing continuous hybrid cell lines and collecting the secreted protein (monoclonal), or by cloning and expressing nucleotide sequences or mutagenized versions thereof coding at least for the amino acid sequences required for specific binding of natural antibodies. Antibodies may include a complete immunoglobulin or fragment thereof, which immunoglobulins  
25 include the various classes and isotypes, such as IgA, IgD, IgE, IgG1, IgG2a, IgG2b and IgG3, IgM, etc. Fragments thereof may include Fab, Fv and F(ab').sub.2, Fab', and the like. In addition, aggregates, polymers, and conjugates of immunoglobulins or their fragments can be used where appropriate so long as binding affinity for a particular molecule is maintained.

30

### BRIEF DESCRIPTION OF THE DRAWINGS

**Figure 1:** Schematic diagram illustrating the formation of nanoparticle aggregates by combining nanoparticles having complementary oligonucleotides attached to them, the nanoparticles being held together in the aggregates as a result of the hybridization of the complementary oligonucleotides. X represents any covalent anchor (such as  $-\text{S}(\text{CH}_2)_3\text{OP}(\text{O})(\text{O}^-)-$ , where S is joined to a gold nanoparticle). For the sake of simplicity in Figure 1 and some subsequent figures, only one oligonucleotide is shown to be attached to each particle but, in fact, each particle has several oligonucleotides attached to it. Also, it is important to note that in Figure 1 and subsequent figures, the relative sizes of the gold nanoparticles and the oligonucleotides are not drawn to scale.

**Figure 2:** Schematic diagram illustrating a system for detecting nucleic acid using nanoparticles having oligonucleotides attached thereto. The oligonucleotides on the two nanoparticles have sequences complementary to two different portions of the single-stranded DNA shown. As a consequence, they hybridize to the DNA producing detectable changes (forming aggregates and producing a color change).

**Figure 3:** Schematic diagram of a variation of the system shown in Figure 2. The oligonucleotides on the two nanoparticles have sequences complementary to two different portions of the single-stranded DNA shown which are separated by a third portion which is not complementary to the oligonucleotides on the nanoparticles. Also shown is an optional filler oligonucleotide which can be used to hybridize with the noncomplementary portion of the single-stranded DNA. When the DNA, nanoparticles and filler oligonucleotides are combined, the nanoparticles aggregate, with the formation of nicked, double-stranded oligonucleotide connectors.

**Figure 4:** Schematic diagram illustrating reversible aggregation of nanoparticles having oligonucleotides attached thereto as a result of hybridization and de-hybridization with a linking oligonucleotide. The illustrated linking oligonucleotide is a double-stranded DNA having overhanging termini (sticky ends) which are complementary to the oligonucleotides attached to the nanoparticles.

**Figure 5:** Schematic diagram illustrating the formation of nanoparticle aggregates by combining nanoparticles having oligonucleotides attached thereto with

linking oligonucleotides having sequences complementary to the oligonucleotides attached to the nanoparticles.

Figure 6: Cuvettes containing two types of gold colloids, each having a different oligonucleotide attached thereto and a linking double-stranded oligonucleotide with sticky ends complementary to the oligonucleotides attached to the nanoparticles (see Figure 4). Cuvette A - at 80°C, which is above the  $T_m$  of the linking DNA; de-hybridized (thermally denatured). The color is dark red. Cuvette B - after cooling to room temperature, which is below the  $T_m$  of the linking DNA; hybridization has taken place, and the nanoparticles have aggregated, but the aggregates have not precipitated. The color is purple. Cuvette C - after several hours at room temperature, the aggregated nanoparticles have settled to the bottom of the cuvette. The solution is clear, and the precipitate is pinkish gray. Heating B or C will result in A.

Figure 7: A graph of absorbance versus wavelength in nm showing changes in absorbance when gold nanoparticles having oligonucleotides attached thereto aggregate due to hybridization with linking oligonucleotides upon lowering of the temperature, as illustrated in Figure 4.

Figures 8A-B: Figure 8A is a graph of change in absorbance versus temperature/time for the system illustrated in Figure 4. At low temperatures, gold nanoparticles having oligonucleotides attached thereto aggregate due to hybridization with linking oligonucleotides (see Figure 4). At high temperature (80°C), the nanoparticles are de-hybridized. Changing the temperature over time shows that this is a reversible process. Figure 8B is a graph of change in absorbance versus temperature/time performed in the same manner using an aqueous solution of unmodified gold nanoparticles. The reversible changes seen in Figure 8A are not observed.

Figures 9A-B: Transmission Electron Microscope (TEM) images. Figure 9A is a TEM image of aggregated gold nanoparticles held together by hybridization of the oligonucleotides on the gold nanoparticles with linking oligonucleotides. Figure 9B is a TEM image of a two-dimensional aggregate showing the ordering of the linked nanoparticles.

Figure 10: Schematic diagram illustrating the formation of thermally-stable triple-stranded oligonucleotide connectors between nanoparticles having the pyrimidine:purine:pyrimidine motif. Such triple-stranded connectors are stiffer than double-stranded connectors. In Figure 10, one nanoparticle has an oligonucleotide attached to it which is composed of all purines, and the other nanoparticle has an oligonucleotide attached to it which is composed of all pyrimidines. The third oligonucleotide for forming the triple-stranded connector (not attached to a nanoparticle) is composed of pyrimidines.

Figure 11: Schematic diagram illustrating the formation of nanoparticle aggregates by combining nanoparticles having complementary oligonucleotides attached to them, the nanoparticles being held together in the aggregates as a result of the hybridization of the complementary oligonucleotides. In Figure 11, the circles represent the nanoparticles, the formulas are oligonucleotide sequences, and s is the thio-alkyl linker. The multiple oligonucleotides on the two types of nanoparticles can hybridize to each other, leading to the formation of an aggregate structure.

Figures 12A-F: Schematic diagrams illustrating systems for detecting nucleic acid using nanoparticles having oligonucleotides attached thereto. Oligonucleotide-nanoparticle conjugates 1 and 2 and single-stranded oligonucleotide targets 3, 4, 5, 6 and 7 are illustrated. The circles represent the nanoparticles, the formulas are oligonucleotide sequences, and the dotted and dashed lines represent connecting links of nucleotide.

Figures 13A-B: Schematic diagrams illustrating systems for detecting DNA (analyte DNA) using nanoparticles and a transparent substrate.

Figures 14A-B: Figure 14A is a graph of absorbance versus wavelength in nm showing changes in absorbance when gold nanoparticles having oligonucleotides attached thereto (one population of which is in solution and one population of which is attached to a transparent substrate as illustrated in Figure 13B) aggregate due to hybridization with linking oligonucleotides. Figure 14B a graph of change in absorbance for the hybridized system referred to in Figure 14A as the temperature is increased (melted).

Figures 15A-G: Schematic diagrams illustrating systems for detecting nucleic acid using nanoparticles having oligonucleotides attached thereto. Oligonucleotide-nanoparticle conjugates 1 and 2 and single-stranded oligonucleotide targets 3, 4, 5, 6, 7 and 8 are illustrated. The circles represent the nanoparticles, the formulas are  
5 oligonucleotide sequences, and S represents the thio-alkyl linker.

Figures 16A-C: Schematic diagrams illustrating systems for detecting nucleic acid using nanoparticles having oligonucleotides attached thereto. Oligonucleotide-nanoparticle conjugates 1 and 2, single-stranded oligonucleotide targets of different lengths, and filler oligonucleotides of different lengths are illustrated. The circles  
10 represent the nanoparticles, the formulas are oligonucleotide sequences, and S represents the thio-alkyl linker.

Figures 17A-E: Schematic diagrams illustrating nanoparticle-oligonucleotide conjugates and systems for detecting nucleic acid using nanoparticles having oligonucleotides attached thereto. The circles represent the nanoparticles, the straight  
15 lines represent oligonucleotide chains (bases not shown), two closely-spaced parallel lines represent duplex segments, and the small letters indicate specific nucleotide sequences (a is complementary to a', b is complementary to b', etc.).

Figure 18: Schematic diagram illustrating a system for detecting nucleic acid using liposomes (large double circle), nanoparticles (small open circles) and a  
20 transparent substrate. The filled-in squares represent cholesteryl groups, the squiggles represent oligonucleotides, and the ladders represent double-stranded (hybridized) oligonucleotides.

Figures 19A-B: Figure 19A is a graph of absorbance versus wavelength in nm showing changes in absorbance when gold nanoparticle-oligonucleotide conjugates  
25 assemble in multiple layers on a transparent substrate as illustrated in Figure 13A. Figure 19B is a graph of change in absorbance for the hybridized system referred to in Figure 19A as the temperature is increased (melted).

Figures 20A-B: Illustrations of schemes using fluorescent-labeled oligonucleotides attached to metallic or semiconductor quenching nanoparticles  
30 (Figure 20A) or to non-metallic, non-semiconductor particles (Figure 20B).

**Figure 21:** Schematic diagram illustrating a system for detecting target nucleic acid using gold nanoparticles having oligonucleotides attached thereto and latex microspheres having fluorescently-labeled oligonucleotides attached thereto. The small, closed, dark circles represent the nanoparticles, the large, open circles represent the latex microspheres, and the large oval represents a microporous membrane.

**Figure 22:** Schematic diagram illustrating a system for detecting target nucleic acid using two types of fluorescently-labeled oligonucleotide-nanoparticle conjugates. The closed circles represent the nanoparticles, and the large oval represents a microporous membrane.

**Figure 23:** Sequences of materials utilized in an assay for Anthrax Protective Antigen (see Example 12).

**Figure 24:** Schematic diagram illustrating a system for detecting target nucleic acid using a "satellite probe" which comprises magnetic nanoparticles (dark spheres) having oligonucleotides (straight lines) attached to them, probe oligonucleotides (straight lines) hybridized to the oligonucleotides attached to the nanoparticles, the probe oligonucleotides being labeled with a reporter group (open rectangular box). A, B, C, A', B', and C' represent specific nucleotide sequences, with A, B and C being complementary to A', B' and C', respectively.

**Figures 25A-B:** Schematic diagrams illustrating systems for detecting DNA using nanoparticles and a transparent substrate. In these figures, a, b and c refer to different oligonucleotide sequences, and a', b' and c' refer to oligonucleotide sequences complementary to a, b and c, respectively.

**Figure 26:** Schematic diagram illustrating systems for forming assemblies of CdSe/ZnS core/shell quantum dots (QD).

**Figures 27A-D:** Figure 27A shows fluorescence spectra comparing dispersed and aggregated QDs, with an excitation at 400 nm. The samples were prepared identically, except for the addition of complementary "linker" DNA to one and an equal volume and concentration of non-complementary DNA to the other. Figure 27B shows UV-Visible spectra of QD/QD assemblies at different temperatures before, during and after "melting". Figure 27C shows high resolution TEM image of



a portion of a hybrid gold/QD assembly. The lattice fringes of the QDs, which resemble fingerprints, appear near each gold nanoparticle. Figure 27D shows UV-Visible spectra of hybrid gold/QD assemblies at different temperatures before, during and after "melting". The insets in Figures 27B and 27D display temperature versus extinction profiles for the thermal denaturation of the assemblies. Denturation experiments were conducted in 0.3 M NaCl, 10 mM phosphate buffer (pH 7), 0.01% sodium azide with 13 nm gold nanoparticles and/or -4 nm CdSe/ZnS core/shell QDs.

Figures 28A-E: Schematic diagrams illustrating the preparation of core probes, aggregate probes and systems for detecting DNA using these probes. In these figures, a, b, c and d refer to different oligonucleotide sequences, and a', b', c' and d' refer to oligonucleotide sequences complementary to a, b, c and d, respectively.

Figure 29: Graph of fractional displacement of oligonucleotides by mercaptoethanol from nanoparticles (closed circles) or gold thin films (open squares) to which the oligonucleotides had been attached.

Figure 30: Graph of surface coverages of recognition oligonucleotides on nanoparticles obtained for different ratios of recognition:diluent oligonucleotides used in the preparation of the nanoparticle-oligonucleotide conjugates.

Figure 31: Graph of surface coverages of hybridized complementary oligonucleotides versus different surface coverages of recognition oligonucleotides on nanoparticles.

Figure 32: Schematic diagram illustrating system for detecting a target DNA in a four-element array on a substrate using nanoparticle-oligonucleotide conjugates and amplification with silver staining.

Figure 33: Images obtained with a flatbed scanner of 7 mm x 13 mm oligonucleotide-functionalized float glass slides. (A) Slide before hybridization of DNA target and gold nanoparticle-oligonucleotide indicator conjugate. (B) Slide A after hybridization of 10 nM target DNA and 5 nM nanoparticle-oligonucleotide indicator conjugate. A pink color was imparted by attached, red 13 nm diameter gold nanoparticles. (C) Slide B after exposure to silver amplification solution for 5 minutes. (D) Same as (A). (E) Slide D after hybridization of 100 pM target and 5 nM nanoparticle-oligonucleotide indicator conjugate. The absorbance of the nanoparticle

layer was too low to be observed with the naked eye or flatbed scanner. (F) Slide E after exposure to silver amplification solution for 5 minutes. Note that slide F is much lighter than slide C, indicating lower target concentration. (G) Control slide, exposed to 5 nM nanoparticle-oligonucleotide indicator conjugate and exposed to silver amplification solution for 5 minutes. No darkening of the slide was observed.

Figure 33: Graph of greyscale (optical density) of oligonucleotide-functionalized glass surface exposed to varying concentrations of target DNA, followed by 5 nM gold of nanoparticle-oligonucleotide indicator conjugates and silver amplification for 5 minutes.

Figures 35A-B: Graphs of percent hybridized label versus temperature showing dissociation of fluorophore-labeled (Figure 35A) and nanoparticle-labeled (Figure 35B) targets from an oligonucleotide-functionalized glass surface. Measurements were made by measuring fluorescence (Figure 35A) or absorbance (Figure 35B) of dissociated label in the solution above the glass surface. The lines labeled "b" show the dissociation curves for perfectly matched oligonucleotides on the glass, and the lines labeled "r" show curves for mismatched oligonucleotides (a one-base mismatch) on the glass. Vertical lines in the graphs illustrate the fraction of target dissociated at a given temperature (halfway between the melting temperatures  $T_m$  of each curve) for each measurement, and the expected selectivity of sequence identification for fluorophore- and nanoparticle-based gene chips. Fluorescence (Figure 35A): complement (69%)/mismatch (38%) = 1.8:1. Absorbance (Figure 35B): complement (85%)/mismatch (14%) = 6:1. The breadth of the fluorophore-labeled curves (Figure 35A) is characteristic of the dissociation of fluorophore-labeled targets from gene chips (Forman et al., in *Molecular Modeling of Nucleic Acids*, Leontis et al., eds., (ACS Symposium Series 682, American Chemical Society, Washington D.C., 1998), pages 206-228).

Figures 36A-B: Images of model oligonucleotide arrays challenged with synthetic target and fluorescent-labeled (Figure 36A) or nanoparticle-labeled (Figure 36B) nanoparticle-oligonucleotide conjugate probes. C, A, T, and G represent spots (elements) on the array where a single base change has been made in the oligonucleotide attached to the substrate to give a perfect match with the target (base

A) or a single base mismatch (base C, T or G in place of the perfect match with base A). The greyscale ratio for elements C:A:T:G is 9:37:9:11 for Figure 36A and 3:62:7:34 for Figure 36B.

5 Figure 37: Schematic diagram illustrating system for forming aggregates (A) or layers (B) of nanoparticles (a and b) linked by a linking nucleic acid (3).

Figure 38A: UV-visible spectra of alternating layers of gold nanoparticles a and b (see Figure 37) hybridized to an oligonucleotide-functionalized glass microscope slide via the complementary linker 3. The spectra are for assemblies with 1 (a,  $\lambda_{\max} = 524$  nm), 2 (b,  $\lambda_{\max} = 529$  nm), 3 (c,  $\lambda_{\max} = 532$  nm), 4 (d,  $\lambda_{\max} = 534$  nm) 10 or 5 (e,  $\lambda_{\max} = 534$  nm) layers. These spectra were measured directly through the slide.

Figure 38B: Graph of absorbance for nanoparticle assemblies (see Figure 38A) at  $\lambda_{\max}$  with increasing numbers of layers.

Figures 39A-F: Figure 39A: FE-SEM of one layer of oligonucleotide- 15 functionalized gold nanoparticles cohybridized with DNA linker to an oligonucleotide-functionalized, conductive indium-tin-oxide (ITO) slide (prepared in the same way as oligonucleotide-functionalized glass slide). The visible absorbance spectrum of this slide was identical to Figure 38A, indicating that functionalization and nanoparticle coverage on ITO is similar to that on glass. The average density of 20 counted nanoparticles from 10 such images was approximately 800 nanoparticles/ $\mu\text{m}^2$ . Figure 39B: FE-SEM image of two layers of nanoparticles on the ITO slide. The average density of counted nanoparticles from 10 such images was approximately 2800 particles/ $\mu\text{m}^2$ . Figure 39C: Absorbance at 260 nm ( $A_{260}$ ) showing dissociation of a 0.5  $\mu\text{M}$  solution of the oligonucleotide duplex (1 + 2 + 3; 25 see Figure 37, A) to single strands in 0.3 M NaCl, 10 mM phosphate buffer solution (pH 7). Figures 39D-F: Absorbance at 260 nm ( $A_{260}$ ) showing dissociation of 1 layer (Figure 39D), 4 layers (Figure 39E) and 10 layers (Figure 39F) of oligonucleotide-functionalized gold nanoparticles from glass slides immersed in 0.3 M NaCl, 10 mM phosphate buffer solution. Melting profiles were obtained by measuring the 30 decreasing absorption at 520 nm ( $A_{520}$ ) through the slides with increasing temperature. In each of Figures 39D-F, the insets show the first derivatives of the

measured dissociation curves. FWHM of these curves were (Figure 39C inset) 13.2 °C, (Figure 39D inset) 5.6 °C, (Figure 39E inset) 3.2 °C, and (Figure 39F inset) 2.9 °C.

5 Figure 40: Schematic diagram illustrating system used to measure the electrical properties of gold nanoparticle assemblies linked by DNA. For simplicity, only one hybridization event is drawn.

Figure 41: Schematic diagram illustrating a method of detecting nucleic acid using gold electrodes and gold nanoparticles.

10 Figure 42: Schematic diagram illustrating the structures of a cyclic disulfide 1, including the preferred compound 1, having a steroid moiety for use in linking oligonucleotides to nanoparticles. The steroid disulfide molecule was obtained by condensation of 4,5-dihydroxy-1,2-dithiane with epiandrosterone. Gold nanoparticle-oligonucleotide conjugates were prepared using oligonucleotides modified with the steroid disulfide exhibit greater stability towards DTT relative to those nanoparticles-oligonucleotides that employ oligonucleotide-mercaptohexyl linkers for their  
15 preparation.

Figure 43: Schematic diagram for the synthesis and formulas for the steroid cyclic disulfide anchor group.

20 Figure 44: Schematic diagram illustrating cyclic disulfides of formulas 2 for use in preparing oligonucleotide-cyclic disulfide linkers as described in Example 24, and same related cyclic disulfides for use as anchor groups.

Figure 45: Schematic diagram illustrating the structures described in Example 25. Figure 45(a) illustrates the structures of 5'-monothiol-modified oligonucleotide 5, a 35-base 5'-steroid disulfide oligomer 6 and Trembler phosphoramidite 7 and 5-tri-mercaptoalkyl oligonucleotide 8.

25 Figure 46: Schematic diagram illustrating the chemistry of making a novel tri-thiol oligonucleotide.

30 Figure 47: Schematic representation of high density oligonucleotide nanoparticle conjugate I, oligonucleotide protein conjugate 1, a nanoparticle-oligonucleotide-protein conjugate II, and probe-target complex III. The oligonucleotide conjugate 1 has a sequence that is complementary to the oligonucleotide bound to conjugate I. Probe II is a representative probe for proteins.

Complex III results from the specific binding interaction between the protein target and the protein bound to probe II.

Figure 48: Schematic representation of the application of Probe II in detecting a specific protein in an array of different proteins immobilized on a glass surface. The gold nanoparticles can be recognized visually or by silver staining. Fluorescent nanoparticles can be recognized by their fluorescence. As shown in this Figure, the glass plate shows three different proteins immobilized on the surface, one of which binds to the protein in Probe II. In step 1, the plate is exposed to a solution containing Probe II. In step 2, unbound Probe II is washed away. In step 3, the presence of bound nanoparticles (IV) at the site occupied by the first protein in the series is observed.

Figure 49: Schematic representation of nanoparticle-oligonucleotide-receptor probes (II') and applications in detecting a specific target in an array of substances immobilized on a smooth surface. The recognition receptor unit (specific binding complement to target) is designated A and the target, B.

Figure 50: Schematic representation of (a) nanoparticle-oligonucleotide-receptor probe (II) showing that the oligonucleotide linked to the receptor (R) is complementary to the oligonucleotide bound to the nanoparticle and that the nanoparticle conjugate is bound by hybridization to the oligonucleotide bound to the receptor and (b) nanoparticle-oligonucleotide-receptor probe (II) showing that the oligonucleotide linked to the receptor (R) is bound, as a result of hybridization, to a first portion of the linking oligonucleotide and the oligonucleotides bound to the nanoparticle are bound, as a result of hybridization, to a second portion of the linking oligonucleotide. For simplicity, only one oligonucleotide-protein conjugate is shown bound to the oligonucleotide-nanoparticle conjugate; the actual number may be greater.

Figure 51: Schematic representation of the application of a probe (Figure 50(b), in (a) detecting a specific target, e.g., drug or protein, in an array of different drug or proteins immobilized on a glass surface and (b) detecting a specific target in a cell having an mixture of different molecules. The probe can also be used in a spot test where the analyte, e.g., protein or drug, has multiple binding sites.

Figure 52: Schematic representation of a 3-dimensional gold nanoparticle-streptavidin assembly or aggregate formed as a result of (a) the hybridization of a complex of streptavidin bound to biotin molecules having bound thereto an oligonucleotide 1, nanoparticle oligonucleotide conjugates 2 and a target nucleic acid 3; (b) a gold nanoparticle assembly from by the hybridization of oligonucleotides of one type of nanoparticle with a second type of nanoparticle; and (c) a gold nanoparticle assembly by the hybridization of a complex of avidin specifically bound to four biotin molecules, each molecule bound to an oligonucleotide that has a sequence that is complementary to the oligonucleotides bound to the nanoparticle. In all three cases, the colors of the solutions changed from red to purple or blue-gray upon aggregate formation.

Figure 53: Photograph illustrating the nonspecific binding test (Example 27) of the inventive gold nanoparticle/oligonucleotide/streptavidin conjugate (left) a commercial gold colloid/streptavidin conjugate (right). The commercial conjugate showed a gray spot, indicating that the conjugate sticks to the glass surface while the inventive conjugate showed no significant silver stain.

Figure 54: Schematic diagram of a gold nanoparticle-oligonucleotide-streptavidin conjugate binding to a biotin bound to surface. The biotin is linked to an oligonucleotide having a sequence that is complementary to an oligonucleotide bound to the surface of the support and oligonucleotide-biotin conjugate is hybridized to the oligonucleotide bound to the surface.

Figure 55: Schematic diagram of a protein detection method using a linker as a DNA reporter for protein. As shown, a nanoparticle-oligonucleotide-biotin conjugate having the reporter DNA bound thereto forms a 3-D nanoparticle assembly on addition of streptavidin. The aggregate is then isolated, and subjected to dehybridization to release nanoparticle-oligonucleotide conjugates, a complex of streptavidin bound to biotin molecules having oligonucleotides bound thereto, and the reporter. The protein is detected by the identification of the reporter DNA by conventional means, including the use of a DNA chip.

Figure 56: Schematic diagram showing the preparation of a gold nanoparticle-oligonucleotide-streptavidin conjugate (Example 26) from (a) streptavidin bound to a

single biotin linked to an oligonucleotide, the oligonucleotide bound to the biotin is further bound, as a result of hybridization, to a first portion of a linker oligonucleotide and (b) a gold nanoparticle having oligonucleotides bound thereto, the oligonucleotides bound to the nanoparticles have a sequence that is complementary to a second portion of the linker oligonucleotide.

**Figure 57:** Transmission electron microscopy (TEM) images (Example 28) showing (a) formation of aggregates upon heating a solution of streptavidin-oligonucleotide conjugate (1-STV), 13 nm gold particles (2-Au) and linker DNA (3) to 53C and (b) particles within the aggregates retain their physical shape prior to and after annealing, show no particle fusion and further demonstrate stabilizing influence of the surface oligonucleotide layer.

**Figure 58:** Melting curves (a) as a function of temperature (b) function of wavelength confirm that streptavidin-nanoparticle aggregates are formed by DNA hybridization interactions, not nonspecific interactions, and that the process is reversible. See Example 28.

**Figure 59:** Small Angle X-ray Scattering diffraction patterns showing various interparticle distances of various aggregates as described in Example 28.

**Figure 60:** Illustration of ITO electrode setup as described in Example 29.

**Figure 61:** The DNA sequences of the array capture strands, the oligonucleotide-functionalized nanoparticle labels, and the targets to be detected were designed to cohybridize in a three-component sandwich assay.

**Figure 62:** Microscope images of model DNA arrays functionalized with oligonucleotide sequences *c* (left) and *d* (right) and incubated with a solution of 50 nm diameter Au nanoparticles functionalized with sequence *a* (10 nM), 100 nm diameter Au nanoparticles functionalized with sequence *b* (3.5 nM), and oligonucleotide target(s) *a'c'* and/or *b'd'* (200 nM).<sup>11</sup> (A) Array and nanoparticles hybridized with both targets *a'c'* and *b'd'*. (B) Array and nanoparticles hybridized with only target *b'd'*. (C) Array and nanoparticles hybridized with only target *a'c'*. (D) Array and nanoparticles incubated in the absence of target. Sequences of DNA used: *a*: 3' TTA TAA CTA TTC CTA A<sub>20</sub> 5' – steroid disulfide (SEQ ID NO:77); *b*: 3' CTC CCT AAT AAC AAT A<sub>20</sub> 5' – steroid disulfide (SEQ ID NO:78); *c*: 3' A<sub>20</sub>

TAT TCT TCC TAT AAT 5' (SEQ ID NO:79); *d*: 3' A<sub>20</sub> TCC CAA TAT AAC  
ATC 5' (SEQ ID NO:80); *a'c'*: 3' TAG GAA TAG TTA TAA ATT ATA GGA  
AGA ATA 5' (SEQ ID NO:81); *b'd'*: 3' ATT GTT ATT AGG GAG GAT GTT  
ATA TTG GGA 5' (SEQ ID NO:82). For details, see Example 30.

5            **Figure 63:** (A) Microscope images of single nucleotide polymorphism (SNP)  
arrays labeled with 50 nm diameter Au nanoparticle probes. Arrays functionalized  
with sequences shown in Figure 61B were incubated with oligonucleotide-  
functionalized particles (10nM) and a synthetic oligonucleotide target (200 nM)  
complementary to only one of the four array sequences (X = A); after washing and  
10            resuspending the array in clean hybridization buffer, images were taken at the  
temperatures shown as the buffer was gradually heated and stirred.<sup>11</sup> (B) Melting  
profiles of 50 nm Au nanoparticle probes from the DNA array surface at elements X =  
A and X = G, determined by quantitative analysis of array images (such as those in  
Figure 63A) obtained during the melting experiment.<sup>17</sup> At  $T = 55^{\circ}\text{C}$  (shown by the  
15            vertical line), taken from the corresponding image in Figure 63A, the fraction of  
remaining hybridized particle label is 0.38 for X = A and 0.08 for X = G. For details,  
see Example 31.

**Figure 64:** Illustration of a slide assembly mounted in a fiber optic illuminator  
(Darklite Illuminator, Micro Video Instruments, Avon, MA) on an inverted  
20            microscope (Axiovert 100A, Carl Zeiss, Jena, Germany) for imaging. Illumination  
was provided by a 200 W halogen source (Fiber-Lite PL-750, Dolan-Jenner,  
Lawrence, MA) set to 40% intensity and allowed to equilibrate for at least 15 min  
before imaging. Images were captured with a Penguin 600 CL digital camera (Pixera,  
Los Gatos, CA). See Example 30.

25            **Figure 65:** Illustration of a slide was mounted on an inverted microscope  
equipped with a controlled temperature stage mount (BS60, Instec Inc., Boulder Co)  
and a miniature magnetic stirrer (Telemodul Mini, H+P Labortechnik, Munich,  
Germany) as shown in Figure 65A (top view) and S2B (side view). The assembly  
was subjected to a temperature ramp from 25 °C to 75 °C at a rate of 0.5°C/min with a  
30            3 min hold at each temperature. Images were captured as described above, and



analyzed using image processing software (Adobe Photoshop 5.0, Adobe Systems, San Jose, CA). See Example 31.

Figure 66. Green curve: Visible spectra of light scattered from glass slides functionalized with oligonucleotide sequence *c* and incubated with a solution of 50 nm diameter Au nanoparticles functionalized with sequence *a* (10 nM) and oligonucleotide target *a'c'* (200 nM). (Details of the hybridization procedure and data collection are given in Examples 30 and 31) Orange curve: Visible spectra of light scattered from glass slides functionalized with oligonucleotide sequence *d* and incubated with a solution of 100 nm diameter Au nanoparticles functionalized with sequence *b* (3.5 nM) and oligonucleotide target *b'd'* (200 nM).

Figure 67. Dependence of scattered light intensity with respect to target oligonucleotide concentration, for arrays spotted with oligonucleotide sequence *c* and incubated with a solution of 50 nm diameter Au nanoparticles functionalized with sequence *a* (10 nM) and oligonucleotide target *a'c'*. Intensity values were determined by analysis of microscope images taken at each target concentration, described in Examples 30 and 31. Each graph point represents the average measured intensity at four array spots.

Figure 68. Detection scheme illustrating (A) selective binding event between a capture oligonucleotide strand located between two electrodes and a target oligonucleotide in solution. The target oligonucleotide has contiguous recognition elements, which are complementary to the capture strand and a nanoparticle probe, respectively. Therefore, when the device with the pair of electrodes is immersed in a solution containing the appropriate probe and target, particles fill the gap. In principle, capacitance or conductivity measurements can be made to determine the number of particles and, therefore, target molecules that fill the gap. However, the sensitivity of the device can be dramatically increased by exposing the active component of the device to a silver stain, e.g., solution of Ag(I) and hydroquinone (photographic developing solution); (B) microelectrodes (60 nm Au on 5nm Ti) with 20  $\mu\text{m}$  gaps were prepared by standard photolithography on a Si wafer with 1000 angstrom coating of SiO<sub>2</sub> as described in Example 32; and (C) the sequences of capture, target, and probe DNA strands in the experiment described in Example 32.

Figure 69. (A) Resistance of the electrode gaps measured as a function of increasing silver enhancing time. (B) Resistance of the electrode gaps as a function of enhancing time. The array was washed with 0.3 M PBS at 50 °C prior to silver enhancing. (C) DNA duplex denaturation curve as a function of  $\text{Na}^+$  concentration for the perfectly complementary oligonucleotide ( $X=A$ ) and the strand with a wobble mismatch ( $X=G$ ). For these experiments, the inside walls of glass cuvettes (Fisher Scientific, Pittsburgh, PA) were functionalized with the appropriate capture strand oligonucleotide and then treated with 0.3 M PBS solution of target DNA (10 nM) for 10 h followed by nanoparticle probes for 5h. The extinction at 520 nm was monitored after washing them with series of buffer solutions with different NaCl concentrations. Inset: Thermal denaturation curves for the perfectly matched DNA ( $X=A$ ) and the one with a wobble mismatch ( $X=G$ ). (D) Resistance of the electrode array was washed with 0.01 M PBS at room temperature prior to silver enhancing.

Figure 70. FE-SEM images of the nanoparticle probes on an ITO-coated glass surface: (A) before silver deposition, (B) after a 3 minute treatment with the enhancing solution, (C) after 6 minute treatment with the enhancer solution, and (D) after 9 minute treatment with silver enhancer solution. ITO-coated glass substrates (Delta Technologies, Stillwater, MN) were modified with complementary capture DNA strands, and the target DNA and oligonucleotide-modified nanoparticles were assembled on the substrates following the same procedure used for DNA detection.

Figure 71. An FE-SEM image of the edge of a DNA spot after the nanoparticle assembly and silver deposition process. The substrate has been treated with a higher concentration of nanoparticles (10 nM), which includes nonspecific binding of nanoparticles on the area where there is no capture DNA strands (below arrow). Note that there is no significant silver deposition below the arrow, even though there is a fair amount of nonspecifically bound nanoparticles. This further demonstrates that the silver reduction catalyzed by deposited silver is responsible for the closing of the gap rather than uniform enlarging of the particles.

30

DETAILED DESCRIPTION OF THE  
PRESENTLY PREFERRED EMBODIMENTS

Nanoparticles useful in the practice of the invention include metal (e.g., gold, silver, copper and platinum), semiconductor (e.g., CdSe, CdS, and CdS or CdSe coated with ZnS) and magnetic (e.g., ferromagnetite) colloidal materials. Other nanoparticles useful in the practice of the invention include ZnS, ZnO, TiO<sub>2</sub>, AgI, AgBr, HgI<sub>2</sub>, PbS, PbSe, ZnTe, CdTe, In<sub>2</sub>S<sub>3</sub>, In<sub>2</sub>Se<sub>3</sub>, Cd<sub>3</sub>P<sub>2</sub>, Cd<sub>3</sub>As<sub>2</sub>, InAs, and GaAs. The size of the nanoparticles is preferably from about 5 nm to about 150 nm (mean diameter), more preferably from about 5 to about 50 nm, most preferably from about 10 to about 30 nm. The nanoparticles may also be rods.

Methods of making metal, semiconductor and magnetic nanoparticles are well-known in the art. See, e.g., Schmid, G. (ed.) *Clusters and Colloids* (VCH, Weinheim, 1994); Hayat, M.A. (ed.) *Colloidal Gold: Principles, Methods, and Applications* (Academic Press, San Diego, 1991); Massart, R., *IEEE Transactions On Magnetics*, **17**, 1247 (1981); Ahmadi, T.S. et al., *Science*, **272**, 1924 (1996); Henglein, A. et al., *J. Phys. Chem.*, **99**, 14129 (1995); Curtis, A.C., et al., *Angew. Chem. Int. Ed. Engl.*, **27**, 1530 (1988).

Methods of making ZnS, ZnO, TiO<sub>2</sub>, AgI, AgBr, HgI<sub>2</sub>, PbS, PbSe, ZnTe, CdTe, In<sub>2</sub>S<sub>3</sub>, In<sub>2</sub>Se<sub>3</sub>, Cd<sub>3</sub>P<sub>2</sub>, Cd<sub>3</sub>As<sub>2</sub>, InAs, and GaAs nanoparticles are also known in the art. See, e.g., Weller, *Angew. Chem. Int. Ed. Engl.*, **32**, 41 (1993); Henglein, *Top. Curr. Chem.*, **143**, 113 (1988); Henglein, *Chem. Rev.*, **89**, 1861 (1989); Brus, *Appl. Phys. A.*, **53**, 465 (1991); Bahncmann, in Photochemical Conversion and Storage of Solar Energy (eds. Pelizzetti and Schiavello 1991), page 251; Wang and Herron, *J. Phys. Chem.*, **95**, 525 (1991); Olshavsky et al., *J. Am. Chem. Soc.*, **112**, 9438 (1990); Ushida et al., *J. Phys. Chem.*, **95**, 5382 (1992).

Suitable nanoparticles are also commercially available from, e.g., Ted Pella, Inc. (gold), Amersham Corporation (gold) and Nanoprobes, Inc. (gold).

Presently preferred for use in detecting nucleic acids are gold nanoparticles. Gold colloidal particles have high extinction coefficients for the bands that give rise to their beautiful colors. These intense colors change with particle size, concentration, interparticle distance, and extent of aggregation and shape (geometry)

of the aggregates, making these materials particularly attractive for colorimetric assays. For instance, hybridization of oligonucleotides attached to gold nanoparticles with oligonucleotides and nucleic acids results in an immediate color change visible to the naked eye (see, e.g., the Examples).

5 Gold nanoparticles are also presently preferred for use in nanofabrication for the same reasons given above and because of their stability, ease of imaging by electron microscopy, and well-characterized modification with thiol functionalities (see below). Also preferred for use in nanofabrication are semiconductor nanoparticles because of their unique electronic and luminescent properties.

10 The nanoparticles, the oligonucleotides or both are functionalized in order to attach the oligonucleotides to the nanoparticles. Such methods are known in the art. For instance, oligonucleotides functionalized with alkanethiols at their 3'-termini or 5'-termini readily attach to gold nanoparticles. See Whitesides, *Proceedings of the Robert A. Welch Foundation 39th Conference On Chemical Research Nanophase*  
15 *Chemistry*, Houston, TX, pages 109-121 (1995). See also, Mucic et al. *Chem. Commun.* 555-557 (1996) (describes a method of attaching 3' thiol DNA to flat gold surfaces; this method can be used to attach oligonucleotides to nanoparticles). The alkanethiol method can also be used to attach oligonucleotides to other metal, semiconductor and magnetic colloids and to the other nanoparticles listed above.

20 Other functional groups for attaching oligonucleotides to solid surfaces include phosphorothioate groups (see, e.g., U.S. Patent No. 5,472,881 for the binding of oligonucleotide-phosphorothioates to gold surfaces), substituted alkylsiloxanes (see, e.g. Burwell, *Chemical Technology*, 4, 370-377 (1974) and Matteucci and Caruthers, *J. Am. Chem. Soc.*, 103, 3185-3191 (1981) for binding of oligonucleotides to silica  
25 and glass surfaces, and Grabar et al., *Anal. Chem.*, 67, 735-743 for binding of aminoalkylsiloxanes and for similar binding of mercaptoalkylsiloxanes).

Oligonucleotides terminated with a 5' thionucleoside or a 3' thionucleoside may also be used for attaching oligonucleotides to solid surfaces. The following references describe other methods which may be employed to attached oligonucleotides to  
30 nanoparticles: Nuzzo et al., *J. Am. Chem. Soc.*, 109, 2358 (1987) (disulfides on gold); Allara and Nuzzo, *Langmuir*, 1, 45 (1985) (carboxylic acids on aluminum); Allara

and Tompkins, *J. Colloid Interface Sci.*, **49**, 410-421 (1974) (carboxylic acids on copper); Iler, *The Chemistry Of Silica*, Chapter 6, (Wiley 1979) (carboxylic acids on silica); Timmons and Zisman, *J. Phys. Chem.*, **69**, 984-990 (1965) (carboxylic acids on platinum); Soriaga and Hubbard, *J. Am. Chem. Soc.*, **104**, 3937 (1982) (aromatic ring compounds on platinum); Hubbard, *Acc. Chem. Res.*, **13**, 177 (1980) (sulfolanes, sulfoxides and other functionalized solvents on platinum); Hickman et al., *J. Am. Chem. Soc.*, **111**, 7271 (1989) (isonitriles on platinum); Maoz and Sagiv, *Langmuir*, **3**, 1045 (1987) (silanes on silica); Maoz and Sagiv, *Langmuir*, **3**, 1034 (1987) (silanes on silica); Wasserman et al., *Langmuir*, **5**, 1074 (1989) (silanes on silica); Eltekova and Eltekov, *Langmuir*, **3**, 951 (1987) (aromatic carboxylic acids, aldehydes, alcohols and methoxy groups on titanium dioxide and silica); Lec et al., *J. Phys. Chem.*, **92**, 2597 (1988) (rigid phosphates on metals).

Oligonucleotides functionalized with a cyclic disulfide are within the scope of this invention. The cyclic disulfides preferably have 5 or 6 atoms in their rings, including the two sulfur atoms. Suitable cyclic disulfides are available commercially or may be synthesized by known procedures. The reduced form of the cyclic disulfides can also be used.

Preferably, the linker further comprises a hydrocarbon moiety attached to the cyclic disulfide. Suitable hydrocarbons are available commercially, and are attached to the cyclic disulfides. Preferably the hydrocarbon moiety is a steroid residue. Oligonucleotide-nanoparticle conjugates prepared using linkers comprising a steroid residue attached to a cyclic disulfide have unexpectedly been found to be remarkably stable to thiols (e.g., dithiothreitol used in polymerase chain reaction (PCR) solutions) as compared to conjugates prepared using alkanethiols or acyclic disulfides as the linker. Indeed, the oligonucleotide-nanoparticle conjugates of the invention have been found to be 300 times more stable. This unexpected stability is likely due to the fact that each oligonucleotide is anchored to a nanoparticle through two sulfur atoms, rather than a single sulfur atom. In particular, it is thought that two adjacent sulfur atoms of a cyclic disulfide would have a chelation effect which would be advantageous in stabilizing the oligonucleotide-nanoparticle conjugates. The large hydrophobic steroid residues of the linkers also appear to contribute to the stability of

the conjugates by screening the nanoparticles from the approach of water-soluble molecules to the surfaces of the nanoparticles.

In view of the foregoing, the two sulfur atoms of the cyclic disulfide should preferably be close enough together so that both of the sulfur atoms can attach  
5 simultaneously to the nanoparticle. Most preferably, the two sulfur atoms are adjacent each other. Also, the hydrocarbon moiety should be large so as to present a large hydrophobic surface screening the surfaces of the nanoparticles.

The oligonucleotide-cyclic nanoparticle conjugates that employ cyclic disulfide linkers may be used as probes in diagnostic assays for detecting nucleic  
10 acids or in methods of nanofabrication as described herein. These conjugates according to the present invention have unexpectedly been found to improve the sensitivity of diagnostic assays in which they are used. In particular, assays employing oligonucleotide-nanoparticle conjugates prepared using linkers comprising a steroid residue attached to a cyclic disulfide have been found to be about 10 times  
15 more sensitive than assays employing conjugates prepared using alkanethiols or acyclic disulfides as the linker.

The surprising stability of the resulting oligonucleotide-nanoparticle conjugates of the invention to thiols described above allows them to be used directly in PCR solutions. Thus, oligonucleotide-nanoparticle conjugates of the invention  
20 added as probes to a DNA target to be amplified by PCR can be carried through the 30 or 40 heating-cooling cycles of the PCR and are still able to detect the amplicons without opening the tubes. Opening the sample tubes for addition of probes after PCR can cause serious problems through contamination of the equipment to be used for subsequent tests.

25 Finally, the invention provides kits comprising a container holding a type of oligonucleotide-cyclic disulfide linkers of the invention or a container holding a type of oligonucleotide-nanoparticle conjugates of the invention. The kits may also contain other reagents and items useful for detecting nucleic acids or for nanofabrication.

Each nanoparticle will have a plurality of oligonucleotides attached to it. As a result, each nanoparticle-oligonucleotide conjugate can bind to a plurality of oligonucleotides or nucleic acids having the complementary sequence.

Oligonucleotides of defined sequences are used for a variety of purposes in the practice of the invention. Methods of making oligonucleotides of a predetermined sequence are well-known. See, e.g., Sambrook *et al.*, *Molecular Cloning: A Laboratory Manual* (2nd ed. 1989) and F. Eckstein (ed.) *Oligonucleotides and Analogues*, 1st Ed. (Oxford University Press, New York, 1991). Solid-phase synthesis methods are preferred for both oligoribonucleotides and oligodeoxyribonucleotides (the well-known methods of synthesizing DNA are also useful for synthesizing RNA). Oligoribonucleotides and oligodeoxyribonucleotides can also be prepared enzymatically.

The invention provides methods of detecting nucleic acids. Any type of nucleic acid may be detected, and the methods may be used, e.g., for the diagnosis of disease and in sequencing of nucleic acids. Examples of nucleic acids that can be detected by the methods of the invention include genes (e.g., a gene associated with a particular disease), viral RNA and DNA, bacterial DNA, fungal DNA, cDNA, mRNA, RNA and DNA fragments, oligonucleotides, synthetic oligonucleotides, modified oligonucleotides, single-stranded and double-stranded nucleic acids, natural and synthetic nucleic acids, etc. Thus, examples of the uses of the methods of detecting nucleic acids include: the diagnosis and/or monitoring of viral diseases (e.g., human immunodeficiency virus, hepatitis viruses, herpes viruses, cytomegalovirus, and Epstein-Barr virus), bacterial diseases (e.g., tuberculosis, Lyme disease, *H. pylori*, *Escherichia coli* infections, *Legionella* infections, *Mycoplasma* infections, *Salmonella* infections), sexually transmitted diseases (e.g., gonorrhea), inherited disorders (e.g., cystic fibrosis, Duchene muscular dystrophy, phenylketonuria, sickle cell anemia), and cancers (e.g., genes associated with the development of cancer); in forensics; in DNA sequencing; for paternity testing; for cell line authentication; for monitoring gene therapy; and for many other purposes.

The methods of detecting nucleic acids based on observing a color change with the naked eye are cheap, fast, simple, robust (the reagents are stable), do not

require specialized or expensive equipment, and little or no instrumentation is required. This makes them particularly suitable for use in, e.g., research and analytical laboratories in DNA sequencing, in the field to detect the presence of specific pathogens, in the doctor's office for quick identification of an infection to  
5 assist in prescribing a drug for treatment, and in homes and health centers for inexpensive first-line screening.

The nucleic acid to be detected may be isolated by known methods, or may be detected directly in cells, tissue samples, biological fluids (e.g., saliva, urine, blood, serum), solutions containing PCR components, solutions containing large excesses of  
10 oligonucleotides or high molecular weight DNA, and other samples, as also known in the art. See, e.g., Sambrook *et al.*, *Molecular Cloning: A Laboratory Manual* (2nd ed. 1989) and B.D. Hames and S.J. Higgins, Eds., *Gene Probes 1* (IRL Press, New York, 1995). Methods of preparing nucleic acids for detection with hybridizing probes are well known in the art. See, e.g., Sambrook *et al.*, *Molecular Cloning: A  
15 Laboratory Manual* (2nd ed. 1989) and B.D. Hames and S.J. Higgins, Eds., *Gene Probes 1* (IRL Press, New York, 1995).

If a nucleic acid is present in small amounts, it may be applied by methods known in the art. See, e.g., Sambrook *et al.*, *Molecular Cloning: A Laboratory  
Manual* (2nd ed. 1989) and B.D. Hames and S.J. Higgins, Eds., *Gene Probes 1* (IRL  
20 Press, New York, 1995). Preferred is polymerase chain reaction (PCR) amplification.

One method according to the invention for detecting nucleic acid comprises contacting a nucleic acid with one or more types of nanoparticles having oligonucleotides attached thereto. The nucleic acid to be detected has at least two  
25 portions. The lengths of these portions and the distance(s), if any, between them are chosen so that when the oligonucleotides on the nanoparticles hybridize to the nucleic acid, a detectable change occurs. These lengths and distances can be determined empirically and will depend on the type of particle used and its size and the type of electrolyte which will be present in solutions used in the assay (as is known in the art, certain electrolytes affect the conformation of nucleic acids).

30 Also, when a nucleic acid is to be detected in the presence of other nucleic acids, the portions of the nucleic acid to which the oligonucleotides on the



nanoparticles are to bind must be chosen so that they contain sufficient unique sequence so that detection of the nucleic acid will be specific. Guidelines for doing so are well known in the art.

Although nucleic acids may contain repeating sequences close enough to each other so that only one type of oligonucleotide-nanoparticle conjugate need be used, this will be a rare occurrence. In general, the chosen portions of the nucleic acid will have different sequences and will be contacted with nanoparticles carrying two or more different oligonucleotides, preferably attached to different nanoparticles. An example of a system for the detection of nucleic acid is illustrated in Figure 2. As can be seen, a first oligonucleotide attached to a first nanoparticle has a sequence complementary to a first portion of the target sequence in the single-stranded DNA. A second oligonucleotide attached to a second nanoparticle has a sequence complementary to a second portion of the target sequence in the DNA. Additional portions of the DNA could be targeted with corresponding nanoparticles. See Figure 17. Targeting several portions of a nucleic acid increases the magnitude of the detectable change.

The contacting of the nanoparticle-oligonucleotide conjugates with the nucleic acid takes place under conditions effective for hybridization of the oligonucleotides on the nanoparticles with the target sequence(s) of the nucleic acid. These hybridization conditions are well known in the art and can readily be optimized for the particular system employed. See, e.g., Sambrook *et al.*, *Molecular Cloning: A Laboratory Manual* (2nd ed. 1989). Preferably stringent hybridization conditions are employed.

Faster hybridization can be obtained by freezing and thawing a solution containing the nucleic acid to be detected and the nanoparticle-oligonucleotide conjugates. The solution may be frozen in any convenient manner, such as placing it in a dry ice-alcohol bath for a sufficient time for the solution to freeze (generally about 1 minute for 100  $\mu$ L of solution). The solution must be thawed at a temperature below the thermal denaturation temperature, which can conveniently be room temperature for most combinations of nanoparticle-oligonucleotide conjugates and

nucleic acids. The hybridization is complete, and the detectable change may be observed, after thawing the solution.

The rate of hybridization can also be increased by warming the solution containing the nucleic acid to be detected and the nanoparticle-oligonucleotide  
5 conjugates to a temperature below the dissociation temperature ( $T_m$ ) for the complex formed between the oligonucleotides on the nanoparticles and the target nucleic acid. Alternatively, rapid hybridization can be achieved by heating above the dissociation temperature ( $T_m$ ) and allowing the solution to cool.

The rate of hybridization can also be increased by increasing the salt  
10 concentration (e.g., from 0.1 M to 0.3 M NaCl).

The detectable change that occurs upon hybridization of the oligonucleotides on the nanoparticles to the nucleic acid may be a color change, the formation of aggregates of the nanoparticles, or the precipitation of the aggregated nanoparticles. The color changes can be observed with the naked eye or spectroscopically. The  
15 formation of aggregates of the nanoparticles can be observed by electron microscopy or by nephelometry. The precipitation of the aggregated nanoparticles can be observed with the naked eye or microscopically. Preferred are changes observable with the naked eye. Particularly preferred is a color change observable with the naked  
eye.

20 The observation of a color change with the naked eye can be made more readily against a background of a contrasting color. For instance, when gold nanoparticles are used, the observation of a color change is facilitated by spotting a sample of the hybridization solution on a solid white surface (such as silica or alumina TLC plates, filter paper, cellulose nitrate membranes, and nylon membranes,  
25 preferably a C-18 silica TLC plate) and allowing the spot to dry. Initially, the spot retains the color of the hybridization solution (which ranges from pink/red, in the absence of hybridization, to purplish-red/purple, if there has been hybridization). On drying at room temperature or 80°C (temperature is not critical), a blue spot develops if the nanoparticle-oligonucleotide conjugates had been linked by hybridization with  
30 the target nucleic acid prior to spotting. In the absence of hybridization (e.g., because no target nucleic acid is present), the spot is pink. The blue and the pink spots are

stable and do not change on subsequent cooling or heating or over time. They provide a convenient permanent record of the test. No other steps (such as a separation of hybridized and unhybridized nanoparticle-oligonucleotide conjugates) are necessary to observe the color change.

5           An alternate method for easily visualizing the assay results is to spot a sample of nanoparticle probes hybridized to a target nucleic acid on a glass fiber filter (*e.g.*, Borosilicate Microfiber Filter, 0.7 micron pore size, grade FG75, for use with gold nanoparticles 13 nm in size), while drawing the liquid through the filter. Subsequent rinsing with water washes the excess, non-hybridized probes through the filter,  
10 leaving behind an observable spot comprising the aggregates generated by hybridization of the nanoparticle probes with the target nucleic acid (retained because these aggregates are larger than the pores of the filter). This technique may provide for greater sensitivity, since an excess of nanoparticle probes can be used. Unfortunately, the nanoparticle probes stick to many other solid surfaces that have  
15 been tried (silica slides, reverse-phase plates, and nylon, nitrocellulose, cellulose and other membranes), and these surfaces cannot be used.

          An important aspect of the detection system illustrated in Figure 2 is that obtaining a detectable change depends on cooperative hybridization of two different oligonucleotides to a given target sequence in the nucleic acid. Mismatches in either  
20 of the two oligonucleotides will destabilize the interparticle connection. It is well known that a mismatch in base pairing has a much greater destabilizing effect on the binding of a short oligonucleotide probe than on the binding of a long oligonucleotide probe. The advantage of the system illustrated in Figure 2 is that it utilizes the base discrimination associated with a long target sequence and probe (eighteen base-pairs  
25 in the example illustrated in Figure 2), yet has the sensitivity characteristic of a short oligonucleotide probe (nine base-pairs in the example illustrated in Figure 2).

          The target sequence of the nucleic acid may be contiguous, as in Figure 2, or the two portions of the target sequence may be separated by a third portion which is not complementary to the oligonucleotides on the nanoparticles, as illustrated in  
30 Figure 3. In the latter case, one has the option of using a filler oligonucleotide which is free in solution and which has a sequence complementary to that of this third

portion (see Figure 3). When the filler oligonucleotide hybridizes with the third portion of the nucleic acid, a double-stranded segment is created, thereby altering the average distance between the nanoparticles and, consequently, the color. The system illustrated in Figure 3 may increase the sensitivity of the detection method.

5           Some embodiments of the method of detecting nucleic acid utilize a substrate. By employing a substrate, the detectable change (the signal) can be amplified and the sensitivity of the assay increased.

          Any substrate can be used which allows observation of the detectable change. Suitable substrates include transparent solid surfaces (e.g., glass, quartz, plastics and  
10       other polymers), opaque solid surface (e.g., white solid surfaces, such as TLC silica plates, filter paper, glass fiber filters, cellulose nitrate membranes, nylon membranes), and conducting solid surfaces (e.g., indium-tin-oxide (ITO)). The substrate can be any shape or thickness, but generally will be flat and thin. Preferred are transparent substrates such as glass (e.g., glass slides) or plastics (e.g., wells of microtiter plates).

15           In one embodiment, oligonucleotides are attached to the substrate. The oligonucleotides can be attached to the substrates as described in, e.g., Chrisey et al., *Nucleic Acids Res.*, **24**, 3031-3039 (1996); Chrisey et al., *Nucleic Acids Res.*, **24**, 3040-3047 (1996); Mucic et al., *Chem. Commun.*, **555** (1996); Zimmermann and Cox, *Nucleic Acids Res.*, **22**, 492 (1994); Bottomley et al., *J. Vac. Sci. Technol. A*, **10**, 591  
20       (1992); and Hegner et al., *FEBS Lett.*, **336**, 452 (1993).

          The oligonucleotides attached to the substrate have a sequence complementary to a first portion of the sequence of a nucleic acid to be detected. The nucleic acid is contacted with the substrate under conditions effective to allow hybridization of the  
25       oligonucleotides on the substrate with the nucleic acid. In this manner the nucleic acid becomes bound to the substrate. Any unbound nucleic acid is preferably washed from the substrate before adding nanoparticle-oligonucleotide conjugates.

          Next, the nucleic acid bound to the substrate is contacted with a first type of nanoparticles having oligonucleotides attached thereto. The oligonucleotides have a sequence complementary to a second portion of the sequence of the nucleic acid, and  
30       the contacting takes place under conditions effective to allow hybridization of the oligonucleotides on the nanoparticles with the nucleic acid. In this manner the first

type of nanoparticles become bound to the substrate. After the nanoparticle-oligonucleotide conjugates are bound to the substrate, the substrate is washed to remove any unbound nanoparticle-oligonucleotide conjugates and nucleic acid.

5 The oligonucleotides on the first type of nanoparticles may all have the same sequence or may have different sequences that hybridize with different portions of the nucleic acid to be detected. When oligonucleotides having different sequences are used, each nanoparticle may have all of the different oligonucleotides attached to it or, preferably, the different oligonucleotides are attached to different nanoparticles. Figure 17 illustrates the use of nanoparticle-oligonucleotide conjugates designed to  
10 hybridize to multiple portions of a nucleic acid. Alternatively, the oligonucleotides on each of the first type of nanoparticles may have a plurality of different sequences, at least one of which must hybridize with a portion of the nucleic acid to be detected (see Figure 25B).

15 Finally, the first type of nanoparticle-oligonucleotide conjugates bound to the substrate is contacted with a second type of nanoparticles having oligonucleotides attached thereto. These oligonucleotides have a sequence complementary to at least a portion of the sequence(s) of the oligonucleotides attached to the first type of nanoparticles, and the contacting takes place under conditions effective to allow hybridization of the oligonucleotides on the first type of nanoparticles with those on  
20 the second type of nanoparticles. After the nanoparticles are bound, the substrate is preferably washed to remove any unbound nanoparticle-oligonucleotide conjugates.

The combination of hybridizations produces a detectable change. The detectable changes are the same as those described above, except that the multiple hybridizations result in an amplification of the detectable change. In particular, since  
25 each of the first type of nanoparticles has multiple oligonucleotides (having the same or different sequences) attached to it, each of the first type of nanoparticle-oligonucleotide conjugates can hybridize to a plurality of the second type of nanoparticle-oligonucleotide conjugates. Also, the first type of nanoparticle-oligonucleotide conjugates may be hybridized to more than one portion of the nucleic  
30 acid to be detected. The amplification provided by the multiple hybridizations may make the change detectable for the first time or may increase the magnitude of the

detectable change. This amplification increases the sensitivity of the assay, allowing for detection of small amounts of nucleic acid.

If desired, additional layers of nanoparticles can be built up by successive additions of the first and second types of nanoparticle-oligonucleotide conjugates. In this way, the number of nanoparticles immobilized per molecule of target nucleic acid can be further increased with a corresponding increase in intensity of the signal.

Also, instead of using first and second types of nanoparticle-oligonucleotide conjugates designed to hybridize to each other directly, nanoparticles bearing oligonucleotides that would serve to bind the nanoparticles together as a consequence of hybridization with binding oligonucleotides could be used.

Methods of making the nanoparticles and the oligonucleotides and of attaching the oligonucleotides to the nanoparticles are described above. The hybridization conditions are well known in the art and can be readily optimized for the particular system employed (see above).

An example of this method of detecting nucleic acid (analyte DNA) is illustrated in Figure 13A. As shown in that Figure, the combination of hybridizations produces dark areas where nanoparticle aggregates are linked to the substrate by analyte DNA. These dark areas may be readily observed with the naked eye using ambient light, preferably viewing the substrate against a white background. As can be readily seen from Figure 13A, this method provides a means of amplifying a detectable change.

Another example of this method of detecting nucleic acid is illustrated in Figure 25B. As in the example illustrated in Figure 13A, the combination of hybridizations produces dark areas where nanoparticle aggregates are linked to the substrate by analyte DNA which can be observed with the naked eye.

In another embodiment, nanoparticles are attached to the substrate. Nanoparticles can be attached to substrates as described in, e.g., Grabar et al., *Analyt. Chem.*, 67, 73-743 (1995); Bethell et al., *J. Electroanal. Chem.*, 409, 137 (1996); Bar et al., *Langmuir*, 12, 1172 (1996); Colvin et al., *J. Am. Chem. Soc.*, 114, 5221 (1992).

After the nanoparticles are attached to the substrate, oligonucleotides are attached to the nanoparticles. This may be accomplished in the same manner

described above for the attachment of oligonucleotides to nanoparticles in solution. The oligonucleotides attached to the nanoparticles have a sequence complementary to a first portion of the sequence of a nucleic acid.

5 The substrate is contacted with the nucleic acid under conditions effective to allow hybridization of the oligonucleotides on the nanoparticles with the nucleic acid. In this manner the nucleic acid becomes bound to the substrate. Unbound nucleic acid is preferably washed from the substrate prior to adding further nanoparticle-oligonucleotide conjugates.

10 Then, a second type of nanoparticles having oligonucleotides attached thereto is provided. These oligonucleotides have a sequence complementary to a second portion of the sequence of the nucleic acid, and the nucleic acid bound to the substrate is contacted with the second type of nanoparticle-oligonucleotide conjugates under conditions effective to allow hybridization of the oligonucleotides on the second type of nanoparticle-oligonucleotide conjugates with the nucleic acid. In this manner, the  
15 second type of nanoparticle-oligonucleotide conjugates becomes bound to the substrate. After the nanoparticles are bound, any unbound nanoparticle-oligonucleotide conjugates and nucleic acid are washed from the substrate. A change (e.g., color change) may be detectable at this point.

20 The oligonucleotides on the second type of nanoparticles may all have the same sequence or may have different sequences that hybridize with different portions of the nucleic acid to be detected. When oligonucleotides having different sequences are used, each nanoparticle may have all of the different oligonucleotides attached to it or, preferably, the different oligonucleotides may be attached to different nanoparticles. See Figure 17.

25 Next, a binding oligonucleotide having a selected sequence having at least two portions, the first portion being complementary to at least a portion of the sequence of the oligonucleotides on the second type of nanoparticles, is contacted with the second type of nanoparticle-oligonucleotide conjugates bound to the substrate under conditions effective to allow hybridization of the binding oligonucleotide to the  
30 oligonucleotides on the nanoparticles. In this manner, the binding oligonucleotide

becomes bound to the substrate. After the binding oligonucleotides are bound, unbound binding oligonucleotides are washed from the substrate.

Finally, a third type of nanoparticles having oligonucleotides attached thereto is provided. The oligonucleotides have a sequence complementary to the sequence of  
5 a second portion of the binding oligonucleotide. The nanoparticle-oligonucleotide conjugates are contacted with the binding oligonucleotide bound to the substrate under conditions effective to allow hybridization of the binding oligonucleotide to the oligonucleotides on the nanoparticles. After the nanoparticles are bound, unbound nanoparticle-oligonucleotide conjugates are washed from the substrate.

10 The combination of hybridizations produces a detectable change. The detectable changes are the same as those described above, except that the multiple hybridizations result in an amplification of the detectable change. In particular, since each of the second type of nanoparticles has multiple oligonucleotides (having the same or different sequences) attached to it, each of the second type of nanoparticle-  
15 oligonucleotide conjugates can hybridize to a plurality of the third type of nanoparticle-oligonucleotide conjugates (through the binding oligonucleotide). Also, the second type of nanoparticle-oligonucleotide conjugates may be hybridized to more than one portion of the nucleic acid to be detected. The amplification provided by the multiple hybridizations may make the change detectable for the first time or may  
20 increase the magnitude of the detectable change. The amplification increases the sensitivity of the assay, allowing for detection of small amounts of nucleic acid.

If desired, additional layers of nanoparticles can be built up by successive additions of the binding oligonucleotides and second and third types of nanoparticle-oligonucleotide conjugates. In this way, the nanoparticles immobilized per molecule  
25 of target nucleic acid can be further increased with a corresponding increase in intensity of the signal.

Also, the use of the binding oligonucleotide can be eliminated, and the second and third types of nanoparticle-oligonucleotide conjugates can be designed so that they hybridize directly to each other.

30 Methods of making the nanoparticles and the oligonucleotides and of attaching the oligonucleotides to the nanoparticles are described above. The hybridization



conditions are well known in the art and can be readily optimized for the particular system employed (see above).

An example of this method of detecting nucleic acid (analyte DNA) is illustrated in Figure 13B. As shown in that Figure, the combination of hybridizations  
5 produces dark areas where nanoparticle aggregates are linked to the substrate by analyte DNA. These dark areas may be readily observed with the naked eye as described above. As can be seen from Figure 13B, this embodiment of the method of the invention provides another means of amplifying the detectable change.

Another amplification scheme employs liposomes. In this scheme,  
10 oligonucleotides are attached to a substrate. Suitable substrates are those described above, and the oligonucleotides can be attached to the substrates as described above. For instance, where the substrate is glass, this can be accomplished by condensing the oligonucleotides through phosphoryl or carboxylic acid groups to aminoalkyl groups on the substrate surface (for related chemistry see Grabar et al., *Anal. Chem.*, **67**, 735-  
15 743 (1995)).

The oligonucleotides attached to the substrate have a sequence complementary to a first portion of the sequence of the nucleic acid to be detected. The nucleic acid is contacted with the substrate under conditions effective to allow hybridization of the oligonucleotides on the substrate with the nucleic acid. In this manner the nucleic  
20 acid becomes bound to the substrate. Any unbound nucleic acid is preferably washed from the substrate before adding additional components of the system.

Next, the nucleic acid bound to the substrate is contacted with liposomes having oligonucleotides attached thereto. The oligonucleotides have a sequence complementary to a second portion of the sequence of the nucleic acid, and the  
25 contacting takes place under conditions effective to allow hybridization of the oligonucleotides on the liposomes with the nucleic acid. In this manner the liposomes become bound to the substrate. After the liposomes are bound to the substrate, the substrate is washed to remove any unbound liposomes and nucleic acid.

The oligonucleotides on the liposomes may all have the same sequence or may  
30 have different sequences that hybridize with different portions of the nucleic acid to be detected. When oligonucleotides having different sequences are used, each

liposome may have all of the different oligonucleotides attached to it or the different oligonucleotides may be attached to different liposomes.

To prepare oligonucleotide-liposome conjugates, the oligonucleotides are linked to a hydrophobic group, such as cholesteryl (see Letsinger et al., *J. Am. Chem. Soc.*, **115**, 7535-7536 (1993)), and the hydrophobic-oligonucleotide conjugates are mixed with a solution of liposomes to form liposomes with hydrophobic-oligonucleotide conjugates anchored in the membrane (see Zhang et al., *Tetrahedron Lett.*, **37**, 6243-6246 (1996)). The loading of hydrophobic-oligonucleotide conjugates on the surface of the liposomes can be controlled by controlling the ratio of hydrophobic-oligonucleotide conjugates to liposomes in the mixture. It has been observed that liposomes bearing oligonucleotides attached by hydrophobic interaction of pendent cholesteryl groups are effective in targeting polynucleotides immobilized on a nitrocellulose membrane (*Id.*). Fluorescein groups anchored in the membrane of the liposome were used as the reporter group. They served effectively, but sensitivity was limited by the fact that the signal from fluorescein in regions of high local concentration (e.g., on the liposome surface) is weakened by self quenching.

The liposomes are made by methods well known in the art. See Zhang et al., *Tetrahedron Lett.*, **37**, 6243 (1996). The liposomes will generally be about 5-50 times larger in size (diameter) than the nanoparticles used in subsequent steps. For instance, for nanoparticles about 13 nm in diameter, liposomes about 100 nm in diameter are preferably used.

The liposomes bound to the substrate are contacted with a first type of nanoparticles having at least a first type of oligonucleotides attached thereto. The first type of oligonucleotides have a hydrophobic group attached to the end not attached to the nanoparticles, and the contacting takes place under conditions effective to allow attachment of the oligonucleotides on the nanoparticles to the liposomes as a result of hydrophobic interactions. A detectable change may be observable at this point.

The method may further comprise contacting the first type of nanoparticle-oligonucleotide conjugates bound to the liposomes with a second type of nanoparticles having oligonucleotides attached thereto. The first type of nanoparticles have a second type of oligonucleotides attached thereto which have a sequence

complementary to at least a portion of the sequence of the oligonucleotides on the second type of nanoparticles, and the oligonucleotides on the second type of nanoparticles have a sequence complementary to at least a portion of the sequence of the second type of oligonucleotides on the first type of nanoparticles. The contacting  
5 takes place under conditions effective to allow hybridization of the oligonucleotides on the first and second types of nanoparticles. This hybridization will generally be performed at mild temperatures (e.g., 5°C to 60°C), so conditions (e.g., 0.3-1.0 M NaCl) conducive to hybridization at room temperature are employed. Following hybridization, unbound nanoparticle-oligonucleotide conjugates are washed from the  
10 substrate.

The combination of hybridizations produces a detectable change. The detectable changes are the same as those described above, except that the multiple hybridizations result in an amplification of the detectable change. In particular, since each of the liposomes has multiple oligonucleotides (having the same or different  
15 sequences) attached to it, each of the liposomes can hybridize to a plurality of the first type of nanoparticle-oligonucleotide conjugates. Similarly, since each of the first type of nanoparticles has multiple oligonucleotides attached to it, each of the first type of nanoparticle-oligonucleotide conjugates can hybridize to a plurality of the second type of nanoparticle-oligonucleotide conjugates. Also, the liposomes may be hybridized to  
20 more than one portion of the nucleic acid to be detected. The amplification provided by the multiple hybridizations may make the change detectable for the first time or may increase the magnitude of the detectable change. This amplification increases the sensitivity of the assay, allowing for detection of small amounts of nucleic acid.

If desired, additional layers of nanoparticles can be built up by successive  
25 additions of the first and second types of nanoparticle-oligonucleotide conjugates. In this way, the number of nanoparticles immobilized per molecule of target nucleic acid can be further increased with a corresponding increase in the intensity of the signal.

Also, instead of using second and third types of nanoparticle-oligonucleotide conjugates designed to hybridize to each other directly, nanoparticles bearing  
30 oligonucleotides that would serve to bring the nanoparticles together as a consequence of hybridization with binding oligonucleotides could be used.

Methods of making the nanoparticles and the oligonucleotides and of attaching the oligonucleotides to the nanoparticles are described above. A mixture of oligonucleotides functionalized at one end for binding to the nanoparticles and with or without a hydrophobic group at the other end can be used on the first type of nanoparticles. The relative ratio of these oligonucleotides bound to the average nanoparticle will be controlled by the ratio of the concentrations of the two oligonucleotides in the mixture. The hybridization conditions are well known in the art and can be readily optimized for the particular system employed (see above).

An example of this method of detecting nucleic acid is illustrated in Figure 18. The hybridization of the first type of nanoparticle-oligonucleotide conjugates to the liposomes may produce a detectable change. In the case of gold nanoparticles, a pink/red color may be observed or a purple/blue color may be observed if the nanoparticles are close enough together. The hybridization of the second type of nanoparticle-oligonucleotide conjugates to the first type of nanoparticle-oligonucleotide conjugates will produce a detectable change. In the case of gold nanoparticles, a purple/blue color will be observed. All of these color changes may be observed with the naked eye.

In yet other embodiments utilizing a substrate, an "aggregate probe" can be used. The aggregate probe can be prepared by allowing two types of nanoparticles having complementary oligonucleotides (a and a') attached to them to hybridize to form a core (illustrated in Figure 28A). Since each type of nanoparticle has a plurality of oligonucleotides attached to it, each type of nanoparticles will hybridize to a plurality of the other type of nanoparticles. Thus, the core is an aggregate containing numerous nanoparticles of both types. The core is then capped with a third type of nanoparticles having at least two types of oligonucleotides attached to them. The first type of oligonucleotides has a sequence b which is complementary to the sequence b' of a portion of a nucleic acid to be detected. The second type of oligonucleotides has sequence a or a' so that the third type of nanoparticles will hybridize to nanoparticles on the exterior of the core. The aggregate probe can also be prepared by utilizing two types of nanoparticles (see Figure 28B). Each type of nanoparticles has at least two types of oligonucleotides attached to them. The first type of oligonucleotides present

on each of the two types of nanoparticles has sequence b which is complementary to the sequence b' of a portion of the nucleic acid to be detected. The second type of oligonucleotides on the first type of nanoparticles has a sequence a which is complementary to the sequence a' of the second type of oligonucleotides on the  
5 second type of nanoparticles (see Figure 28B) so that the two types of nanoparticles hybridize to each other to form the aggregate probe. Since each type of nanoparticles has a plurality of oligonucleotides attached to it, each type of nanoparticles will hybridize to a plurality of the other type of nanoparticles to form an aggregate containing numerous nanoparticles of both types.

10 The aggregate probe can be utilized to detect nucleic acid in any of the above assay formats performed on a substrate, eliminating the need to build up layers of individual nanoparticles in order to obtain or enhance a detectable change. To even further enhance the detectable change, layers of aggregate probes can be built up by using two types of aggregate probes, the first type of aggregate probe having  
15 oligonucleotides attached to it that are complementary to oligonucleotides on the other type of aggregate probe. In particular, when the aggregate probe is prepared as illustrated in Figure 28B, the aggregate probes can hybridize to each other to form the multiple layers. Some of the possible assay formats utilizing aggregate probes are illustrated in Figures 28C-D. For instance, a type of oligonucleotides comprising  
20 sequence c is attached to a substrate (see Figure 28C). Sequence c is complementary to the sequence c' of a portion of a nucleic acid to be detected. The target nucleic acid is added and allowed to hybridize to the oligonucleotides attached to the substrate, after which the aggregate probe is added and allowed to hybridize to the portion of the target nucleic acid having sequence b', thereby producing a detectable  
25 change. Alternatively, the target nucleic acid can first be hybridized to the aggregate probe in solution and subsequently hybridized to the oligonucleotides on the substrate, or the target nucleic acid can simultaneously be hybridized to the aggregate probe and the oligonucleotides on the substrate. In another embodiment, the target nucleic acid is allowed to react with the aggregate probe and another type of nanoparticles in  
30 solution (see Figure 28D). Some of the oligonucleotides attached to this additional type of nanoparticles comprise sequence c so that they hybridize to sequence c' of the

target nucleic acid and some of the oligonucleotides attached to this additional type of nanoparticles comprise sequence d so that they can subsequently hybridize to oligonucleotides comprising sequence d' which are attached to the substrate.

The core itself can also be used as a probe to detect nucleic acids. One  
5 possible assay format is illustrated in Figure 28E. As illustrated there, a type of oligonucleotides comprising sequence b is attached to a substrate. Sequence b is complementary to the sequence b' of a portion of a nucleic acid to be detected. The target nucleic acid is contacted with the substrate and allowed to hybridize to the oligonucleotides attached to the substrate. Then, another type of nanoparticles is  
10 added. Some of the oligonucleotides attached to this additional type of nanoparticles comprise sequence c so which is complementary to sequence c' of the target nucleic acid so that the nanoparticles hybridize to the target nucleic acid bound to the substrate. Some of the oligonucleotides attached to the additional type of nanoparticles comprise sequence a or a' complementary to sequences a and a' on the  
15 core probe, and the core probe is added and allowed to hybridize to the oligonucleotides on the nanoparticles. Since each core probe has sequences a and a' attached to the nanoparticles which comprise the core, the core probes can hybridize to each other to form multiple layers attached to the substrate, providing a greatly enhanced detectable change. In alternative embodiments, the target nucleic acid  
20 could be contacted with the additional type of nanoparticles in solution prior to being contacted with the substrate, or the target nucleic acid, the nanoparticles and the substrate could all be contacted simultaneously. In yet another alternative embodiment, the additional type of nanoparticles could be replaced by a linking oligonucleotide comprising both sequences c and a or a'.

25 When a substrate is employed, a plurality of the initial types of nanoparticle-oligonucleotide conjugates or oligonucleotides can be attached to the substrate in an array for detecting multiple portions of a target nucleic acid, for detecting multiple different nucleic acids, or both. For instance, a substrate may be provided with rows of spots, each spot containing a different type of oligonucleotide or oligonucleotide-  
30 nanoparticle conjugate designed to bind to a portion of a target nucleic acid. A sample containing one or more nucleic acids is applied to each spot, and the rest of

the assay is performed in one of the ways described above using appropriate oligonucleotide-nanoparticle conjugates, oligonucleotide-liposome conjugates, aggregate probes, core probes, and binding oligonucleotides.

5 Finally, when a substrate is employed, a detectable change can be produced or further enhanced by silver staining. Silver staining can be employed with any type of nanoparticles that catalyze the reduction of silver. Preferred are nanoparticles made of noble metals (*e.g.*, gold and silver). See Bassell, et al., *J. Cell Biol.*, **126**, 863-876 (1994); Braun-Howland et al., *Biotechniques*, **13**, 928-931 (1992). If the  
10 nanoparticles being employed for the detection of a nucleic acid do not catalyze the reduction of silver, then silver ions can be complexed to the nucleic acid to catalyze the reduction. See Braun et al., *Nature*, **391**, 775 (1998). Also, silver stains are known which can react with the phosphate groups on nucleic acids.

15 Silver staining can be used to produce or enhance a detectable change in any assay performed on a substrate, including those described above. In particular, silver staining has been found to provide a huge increase in sensitivity for assays employing a single type of nanoparticle, such as the one illustrated in Figure 25A, so that the use of layers of nanoparticles, aggregate probes and core probes can often be eliminated.

20 In assays for detecting nucleic acids performed on a substrate, the detectable change can be observed with an optical scanner. Suitable scanners include those used to scan documents into a computer which are capable of operating in the reflective mode (*e.g.*, a flatbed scanner), other devices capable of performing this function or which utilize the same type of optics, any type of greyscale-sensitive measurement device, and standard scanners which have been modified to scan substrates according to the invention (*e.g.*, a flatbed scanner modified to include a holder for the substrate)  
25 (to date, it has not been found possible to use scanners operating in the transmissive mode). The resolution of the scanner must be sufficient so that the reaction area on the substrate is larger than a single pixel of the scanner. The scanner can be used with any substrate, provided that the detectable change produced by the assay can be observed against the substrate (*e.g.*, a grey spot, such as that produced by silver  
30 staining, can be observed against a white background, but cannot be observed against a grey background). The scanner can be a black-and-white scanner or, preferably, a

color scanner. Most preferably, the scanner is a standard color scanner of the type used to scan documents into computers. Such scanners are inexpensive and readily available commercially. For instance, an Epson Expression 636 (600 x 600 dpi), a UMAX Astra 1200 (300 x 300 dpi), or a Microtec 1600 (1600 x 1600 dpi) can be used. The scanner is linked to a computer loaded with software for processing the images obtained by scanning the substrate. The software can be standard software which is readily available commercially, such as Adobe Photoshop 5.2 and Corel Photopaint 8.0. Using the software to calculate greyscale measurements provides a means of quantitating the results of the assays. The software can also provide a color number for colored spots and can generate images (e.g., printouts) of the scans which can be reviewed to provide a qualitative determination of the presence of a nucleic acid, the quantity of a nucleic acid, or both. In addition, it has been found that the sensitivity of assays such as that described in Example 5 can be increased by subtracting the color that represents a negative result (red in Example 5) from the color that represents a positive result (blue in Example 5). The computer can be a standard personal computer which is readily available commercially. Thus, the use of a standard scanner linked to a standard computer loaded with standard software can provide a convenient, easy, inexpensive means of detecting and quantitating nucleic acids when the assays are performed on substrates. The scans can also be stored in the computer to maintain a record of the results for further reference or use. Of course, more sophisticated instruments and software can be used, if desired.

A nanoparticle-oligonucleotide conjugate which may be used in an assay for any nucleic acid is illustrated in Figures 17D-E. This "universal probe" has oligonucleotides of a single sequence attached to it. These oligonucleotides can hybridize with a binding oligonucleotide which has a sequence comprising at least two portions. The first portion is complementary to at least a portion of the sequence of the oligonucleotides on the nanoparticles. The second portion is complementary to a portion of the sequence of the nucleic acid to be detected. A plurality of binding oligonucleotides having the same first portion and different second portions can be used, in which case the "universal probe", after hybridization to the binding



oligonucleotides, can bind to multiple portions of the nucleic acid to be detected or to different nucleic acid targets.

In a number of other embodiments of the invention, the detectable change is created by labeling the oligonucleotides, the nanoparticles, or both with molecules  
5 (e.g., fluorescent molecules and dyes) that produce detectable changes upon hybridization of the oligonucleotides on the nanoparticles with the target nucleic acid. For instance, oligonucleotides attached to metal and semiconductor nanoparticles can have a fluorescent molecule attached to the end not attached to the nanoparticles. Metal and semiconductor nanoparticles are known fluorescence quenchers, with the  
10 magnitude of the quenching effect depending on the distance between the nanoparticles and the fluorescent molecule. In the unhybridized state, the oligonucleotides attached to the nanoparticles interact with the nanoparticles, so that significant quenching will be observed. See Figure 20A. Upon hybridization to a target nucleic acid, the fluorescent molecule will become spaced away from the  
15 nanoparticles, diminishing quenching of the fluorescence. See Figure 20A. Longer oligonucleotides should give rise to larger changes in fluorescence, at least until the fluorescent groups are moved far enough away from the nanoparticle surfaces so that an increase in the change is no longer observed. Useful lengths of the oligonucleotides can be determined empirically. Metallic and semiconductor nanoparticles having  
20 fluorescent-labeled oligonucleotides attached thereto can be used in any of the assay formats described above, including those performed in solution or on substrates.

Methods of labeling oligonucleotides with fluorescent molecules and measuring fluorescence are well known in the art. Suitable fluorescent molecules are also well known in the art and include the fluoresceins, rhodamines and Texas Red.  
25 The oligonucleotides will be attached to the nanoparticles as described above.

In yet another embodiment, two types of fluorescent-labeled oligonucleotides attached to two different particles can be used. Suitable particles include polymeric particles (such as polystyrene particles, polyvinyl particles, acrylate and methacrylate particles), glass particles, latex particles, Sepharose beads and others like particles  
30 well known in the art. Methods of attaching oligonucleotides to such particles are well known in the art. See Chrissey et al., *Nucleic Acids Research*, 24, 3031-3039

(1996) (glass) and Charreyre et al., *Langmuir*, **13**, 3103-3110 (1997), Fahy et al., *Nucleic Acids Research*, **21**, 1819-1826 (1993), Elaissari et al., *J. Colloid Interface Sci.*, **202**, 251-260 (1998), Kolarova et al., *Biotechniques*, **20**, 196-198 (1996) and Wolf et al., *Nucleic Acids Research*, **15**, 2911-2926 (1987) (polymer/latex). In

5 particular, a wide variety of functional groups are available on the particles or can be incorporated into such particles. Functional groups include carboxylic acids, aldehydes, amino groups, cyano groups, ethylene groups, hydroxyl groups, mercapto groups, and the like. Nanoparticles, including metallic and semiconductor nanoparticles, can also be used.

10 The two fluorophores are designated **d** and **a** for donor and acceptor. A variety of fluorescent molecules useful in such combinations are well known in the art and are available from, e.g., Molecular Probes. An attractive combination is fluorescein as the donor and Texas Red as acceptor. The two types of nanoparticle-oligonucleotide conjugates with **d** and **a** attached are mixed with the target nucleic  
15 acid, and fluorescence measured in a fluorimeter. The mixture will be excited with light of the wavelength that excites **d**, and the mixture will be monitored for fluorescence from **a**. Upon hybridization, **d** and **a** will be brought in proximity (see Figure 20B). In the case of non-metallic, non-semiconductor particles, hybridization will be shown by a shift in fluorescence from that for **d** to that for **a** or by the  
20 appearance of fluorescence for **a** in addition to that for **d**. In the absence of hybridization, the fluorophores will be too far apart for energy transfer to be significant, and only the fluorescence of **d** will be observed. In the case of metallic and semiconductor nanoparticles, lack of hybridization will be shown by a lack of fluorescence due to **d** or **a** because of quenching (see above). Hybridization will be  
25 shown by an increase in fluorescence due to **a**.

As will be appreciated, the above described particles and nanoparticles having oligonucleotides labeled with acceptor and donor fluorescent molecules attached can be used in the assay formats described above, including those performed in solution and on substrates. For solution formats, the oligonucleotide sequences are preferably  
30 chosen so that they bind to the target nucleic acid as illustrated in Figures 15A-G. In the formats shown in Figure 13A-B and 18, the binding oligonucleotides may be used

to bring the acceptor and donor fluorescent molecules on the two nanoparticles in proximity. Also, in the format illustrated in Figure 13A, the oligonucleotides attached the substrate may be labeled with d. Further, other labels besides fluorescent molecules can be used, such as chemiluminescent molecules, which will give a detectable signal or a change in detectable signal upon hybridization.

Another embodiment of the detection method of the invention is a very sensitive system that utilizes detection of changes in fluorescence and color (illustrated in Figure 21). This system employs latex microspheres to which are attached oligonucleotides labeled with a fluorescent molecule and gold nanoparticles to which are attached oligonucleotides. The oligonucleotide-nanoparticle conjugates can be prepared as described above. Methods of attaching oligonucleotides to latex microspheres are well known (see, *e.g.*, Charreyre et al., *Langmuir*, 13:3103-3110 (1997); Elaissari et al., *J. Colloid Interface Sci.*, 202:251-260 (1998)), as are methods of labeling oligonucleotides with fluorescent molecules (see above). The oligonucleotides on the latex microspheres and the oligonucleotides on the gold nanoparticles have sequences capable of hybridizing with different portions of the sequence of a target nucleic acid, but not with each other. When a target nucleic acid comprising sequences complementary to the sequences of the oligonucleotides on the latex microspheres and gold nanoparticles is contacted with the two probes, a network structure is formed (see Figure 21). Due to the quenching properties of the gold nanoparticles, the fluorescence of the oligonucleotides attached to the latex microspheres is quenched while part of this network. Indeed, one gold nanoparticle can quench many fluorophore molecules since gold nanoparticles have very large absorption coefficients. Thus, the fluorescence of a solution containing nucleic acid and the two particles can be monitored to detect the results, with a reduction in, or elimination of, fluorescence indicating a positive result. Preferably, however, the results of the assay are detected by placing a droplet of the solution onto a microporous material (see Figure 21). The microporous material should be transparent or a color (*e.g.*, white) which allows for detection of the pink/red color of the gold nanoparticles. The microporous material should also have a pore size sufficiently large to allow the gold nanoparticles to pass through the pores and

sufficiently small to retain the latex microspheres on the surface of the microporous material when the microporous material is washed. Thus, when using such a microporous material, the size (diameter) of the latex microspheres must be larger than the size (diameter) of the gold nanoparticles. The microporous material must also be inert to biological media. Many suitable microporous materials are known in the art and include various filters and membranes, such as modified polyvinylidene fluoride (PVDF, such as Durapore™ membrane filters purchased from Millipore Corp.) and pure cellulose acetate (such as AcetatePlus™ membrane filters purchased from Micron Separations Inc.). Such a microporous material retains the network composed of target nucleic acid and the two probes, and a positive result (presence of the target nucleic acid) is evidenced by a red/pink color (due to the presence of the gold nanoparticles) and a lack of fluorescence (due to quenching of fluorescence by the gold nanoparticles) (see Figure 21). A negative result (no target nucleic acid present) is evidenced by a white color and fluorescence, because the gold nanoparticles would pass through the pores of the microporous material when it is washed (so no quenching of the fluorescence would occur), and the white latex microspheres would be trapped on top of it (see Figure 21). In addition, in the case of a positive result, changes in fluorescence and color can be observed as a function of temperature. For instance, as the temperature is raised, fluorescence will be observed once the dehybridization temperature has been reached. Therefore, by looking at color or fluorescence as a function of temperature, information can be obtained about the degree of complementarity between the oligonucleotide probes and the target nucleic acid. As noted above, this detection method exhibits high sensitivity. As little as 3 femtomoles of single-stranded target nucleic acid 24 bases in length and 20 femtomoles of double-stranded target nucleic acid 24 bases in length have been detected with the naked eye. The method is also very simple to use. Fluorescence can be generated by simply illuminating the solution or microporous material with a UV lamp, and the fluorescent and colorimetric signals can be monitored by the naked eye. Alternatively, for a more quantitative result, a fluorimeter can be employed in front-face mode to measure the fluorescence of the solution with a short path length.

The above embodiment has been described with particular reference to latex microspheres and gold nanoparticles. Any other microsphere or nanoparticle, having the other properties described above and to which oligonucleotides can be attached, can be used in place of these particles. Many suitable particles and nanoparticles are described above, along with techniques for attaching oligonucleotides to them. In addition, microspheres and nanoparticles having other measurable properties may be used. For instance, polymer-modified particles and nanoparticles, where the polymer can be modified to have any desirable property, such as fluorescence, color, or electrochemical activity, can be used. See, Watson et al., *J. Am. Chem. Soc.*, **121**, 462-463 (1999) (polymer-modified gold nanoparticles). Also, magnetic, polymer-coated magnetic, and semiconducting particles can be used. See Chan et al., *Science*, **281**, 2016 (1998); Bruchez et al., *Science*, **281**, 2013 (1998); Kolarova et al., *Biotechniques*, **20**, 196-198 (1996).

In yet another embodiment, two probes comprising metallic or semiconductor nanoparticles having oligonucleotides labeled with fluorescent molecules attached to them are employed (illustrated in Figure 22). The oligonucleotide-nanoparticle conjugates can be prepared and labeled with fluorescent molecules as described above. The oligonucleotides on the two types of oligonucleotide-nanoparticle conjugates have sequences capable of hybridizing with different portions of the sequence of a target nucleic acid, but not with each other. When a target nucleic acid comprising sequences complementary to the sequences of the oligonucleotides on the nanoparticles is contacted with the two probes, a network structure is formed (see Figure 22). Due to the quenching properties of the metallic or semiconductor nanoparticles, the fluorescence of the oligonucleotides attached to the nanoparticles is quenched while part of this network. Thus, the fluorescence of a solution containing nucleic acid and the two probes can be monitored to detect the results, with a reduction in, or elimination of, fluorescence indicating a positive result. Preferably, however, the results of the assay are detected by placing a droplet of the solution onto a microporous material (see Figure 22). The microporous material should have a pore size sufficiently large to allow the nanoparticles to pass through the pores and sufficiently small to retain the network on the surface of the microporous material

when the microporous material is washed (see Figure 22). Many suitable microporous materials are known in the art and include those described above. Such a microporous material retains the network composed of target nucleic acid and the two probes, and a positive result (presence of the target nucleic acid) is evidenced by a lack of fluorescence (due to quenching of fluorescence by the metallic or semiconductor nanoparticles) (see Figure 22). A negative result (no target nucleic acid present) is evidenced by fluorescence because the nanoparticles would pass through the pores of the microporous material when it is washed (so no quenching of the fluorescence would occur) (see Figure 22). There is low background fluorescence because unbound probes are washed away from the detection area. In addition, in the case of a positive result, changes in fluorescence can be observed as a function of temperature. For instance, as the temperature is raised, fluorescence will be observed once the dehybridization temperature has been reached. Therefore, by looking at fluorescence as a function of temperature, information can be obtained about the degree of complementarity between the oligonucleotide probes and the target nucleic acid. Fluorescence can be generated by simply illuminating the solution or microporous material with a UV lamp, and the fluorescent signal can be monitored by the naked eye. Alternatively, for a more quantitative result, a fluorimeter can be employed in front-face mode to measure the fluorescence of the solution with a short path length.

In yet other embodiments, a "satellite probe" is used (see Figure 24). The satellite probe comprises a central particle with one or several physical properties that can be exploited for detection in an assay for nucleic acids (e.g., intense color, fluorescence quenching ability, magnetism). Suitable particles include the nanoparticles and other particles described above. The particle has oligonucleotides (all having the same sequence) attached to it (see Figure 24). Methods of attaching oligonucleotides to the particles are described above. These oligonucleotides comprise at least a first portion and a second portion, both of which are complementary to portions of the sequence of a target nucleic acid (see Figure 24). The satellite probe also comprises probe oligonucleotides. Each probe oligonucleotide has at least a first portion and a second portion (see Figure 24). The

sequence of the first portion of the probe oligonucleotides is complementary to the first portion of the sequence of the oligonucleotides immobilized on the central particle (see Figure 24). Consequently, when the central particle and the probe oligonucleotides are brought into contact, the oligonucleotides on the particle  
5 hybridize with the probe oligonucleotides to form the satellite probe (see Figure 24). Both the first and second portions of the probe oligonucleotides are complementary to portions of the sequence of the target nucleic acid (see Figure 24). Each probe oligonucleotide is labeled with a reporter molecule (see Figure 24), as further described below. The amount of hybridization overlap between the probe  
10 oligonucleotides and the target (length of the portion hybridized) is as large as, or greater than, the hybridization overlap between the probe oligonucleotides and the oligonucleotides attached to the particle (see Figure 24). Therefore, temperature cycling resulting in dehybridization and rehybridization would favor moving the probe oligonucleotides from the central particle to the target. Then, the particles are  
15 separated from the probe oligonucleotides hybridized to the target, and the reporter molecule is detected.

The satellite probe can be used in a variety of detection strategies. For example, if the central particle has a magnetic core and is covered with a material capable of quenching the fluorescence of fluorophores attached to the probe  
20 oligonucleotides that surround it, this system can be used in an *in situ* fluorometric detection scheme for nucleic acids. Functionalized polymer-coated magnetic particles ( $\text{Fe}_3\text{O}_4$ ) are available from several commercial sources including Dynal (Dynabeads™) and Bangs Laboratories (Estapor™), and silica-coated magnetic  
25  $\text{Fe}_3\text{O}_4$  nanoparticles could be modified (Liu et al., *Chem. Mater.*, **10**, 3936-3940 (1998)) using well-developed silica surface chemistry (Chrissey et al., *Nucleic Acids Research*, **24**, 3031-3039 (1996)) and employed as magnetic probes as well. Further, the dye molecule, 4-((4-(dimethylamino)phenyl)-azo)benzoic acid (DABCYL) has been shown to be an efficient quencher of fluorescence for a wide variety of  
30 fluorophores attached to oligonucleotides (Tyagi et al., *Nature Biotech.*, **16**, 49-53 (1998)). The commercially-available succinimidyl ester of DABCYL (Molecular Probes) forms extremely stable amide bonds upon reaction with primary alkylamino

groups. Thus, any magnetic particle or polymer-coated magnetic particle with primary alkyl amino groups could be modified with both oligonucleotides, as well as these quencher molecules. Alternatively, the DABCYL quencher could be attached directly to the surface-bound oligonucleotide, instead of the alkyl amino-modified surface. The satellite probe comprising the probe oligonucleotides is brought into contact with the target. The temperature is cycled so as to cause dehybridization and rehybridization, which causes the probe oligonucleotides to move from the central particle to the target. Detection is accomplished by applying a magnetic field and removing the particles from solution and measuring the fluorescence of the probe oligonucleotides remaining in solution hybridized to the target.

This approach can be extended to a colorimetric assay by using magnetic particles with a dye coating in conjunction with probe oligonucleotides labeled with a dye which has optical properties that are distinct from the dye on the magnetic nanoparticles or perturb those of the dye on the magnetic nanoparticles. When the particles and the probe oligonucleotides are in solution together, the solution will exhibit one color which derives from a combination of the two dyes. However, in the presence of a target nucleic acid and with temperature cycling, the probe oligonucleotides will move from the satellite probe to the target. Once this has happened, application of a magnetic field will remove the magnetic, dye-coated particles from solution leaving behind probe oligonucleotides labeled with a single dye hybridized to the target. The system can be followed with a colorimeter or the naked eye, depending upon target levels and color intensities.

This approach also can be further extended to an electrochemical assay by using an oligonucleotide-magnetic particle conjugate in conjunction with a probe oligonucleotide having attached a redox-active molecule. Any modifiable redox-active species can be used, such as the well-studied redox-active ferrocene derivative. A ferrocene derivatized phosphoramidite can be attached to oligonucleotides directly using standard phosphoramidite chemistry. Mucic et al., *Chem. Commun.*, 555 (1996); Eckstein, ed., in *Oligonucleotides and Analogues*, 1st ed., Oxford University, New York, NY (1991). The ferrocenylphosphoramidite is prepared in a two-step synthesis from 6-bromohexylferrocene. In a typical preparation, 6-



bromohexylferrocene is stirred in an aqueous HMPA solution at 120°C for 6 hours to form 6-hydroxyhexylferrocene. After purification, the 6-hydroxyhexylferrocene is added to a THF solution of N,N-diisopropylethylamine and beta-cyanoethyl-N,N-diisopropylchlorophosphoramidite to form the ferrocenylphosphoramidite.

- 5 Oligonucleotide-modified polymer-coated gold nanoparticles, where the polymer contains electrochemically-active ferrocene molecules, could also be utilized. Watson et al., *J. Am. Chem. Soc.*, **121**, 462-463 (1999). A copolymer of amino reactive sites (e.g., anhydrides) could be incorporated into the polymer for reaction with amino-modified oligonucleotides. Moller et al., *Bioconjugate Chem.*, **6**, 174-178 (1995). In
- 10 the presence of target and with temperature cycling, the redox-active probe oligonucleotides will move from the satellite probe to the target. Once this has happened, application of the magnetic field will remove the magnetic particles from solution leaving behind the redox-active probe oligonucleotides hybridized with the target nucleic acid. The amount of target then can be determined by cyclic
- 15 voltammetry or any electrochemical technique that can interrogate the redox-active molecule.

- In yet another embodiment of the invention, a nucleic acid is detected by contacting the nucleic acid with a substrate having oligonucleotides attached thereto. The oligonucleotides have a sequence complementary to a first portion of the
- 20 sequence of the nucleic acid. The oligonucleotides are located between a pair of electrodes located on the substrate. The substrate must be made of a material which is not a conductor of electricity (e.g., glass, quartz, polymers, plastics). The electrodes may be made of any standard material (e.g., metals, such as gold, platinum, tin oxide). The electrodes can be fabricated by conventional microfabrication
- 25 techniques. See, e.g., Introduction To Microlithography (L.F. Thompson et al., eds., American Chemical Society, Washington, D.C. 1983). The substrate may have a plurality of pairs of electrodes located on it in an array to allow for the detection of multiple portions of a single nucleic acid, the detection of multiple different nucleic acids, or both. Arrays of electrodes can be purchased (e.g., from AbbttechScientific,
- 30 Inc., Richmond, Virginia) or can be made by conventional microfabrication techniques. See, e.g., Introduction To Microlithography (L.F. Thompson et al., eds.,

American Chemical Society, Washington, D.C. 1983). Suitable photomasks for making the arrays can be purchased (e.g., from Photonics, Milpitas, CA). Each of the pairs of electrodes in the array will have a type of oligonucleotides attached to the substrate between the two electrodes. The contacting takes place under conditions

5 effective to allow hybridization of the oligonucleotides on the substrate with the nucleic acid. Then, the nucleic acid bound to the substrate, is contacted with a type of nanoparticles. The nanoparticles must be made of a material which can conduct electricity. Such nanoparticles include those made of metal, such as gold nanoparticles, and semiconductor materials. The nanoparticles will have one or more

10 types of oligonucleotides attached to them, at least one of the types of oligonucleotides having a sequence complementary to a second portion of the sequence of the nucleic acid. The contacting takes place under conditions effective to allow hybridization of the oligonucleotides on the nanoparticles with the nucleic acid. If the nucleic acid is present, the circuit between the electrodes should be closed

15 because of the attachment of the nanoparticles to the substrate between the electrodes, and a change in conductivity will be detected. If the binding of a single type of nanoparticles does not result in closure of the circuit, this situation can be remedied by using a closer spacing between the electrodes, using larger nanoparticles, or employing another material that will close the circuit (but only if the nanoparticles

20 have been bound to the substrate between the electrodes). For instance, when gold nanoparticles are used, the substrate can be contacted with silver stain (as described above) to deposit silver between the electrodes to close the circuit and produce the detectable change in conductivity. Another way to close the circuit in the case where the addition of a single type of nanoparticles is not sufficient, is to contact the first

25 type of nanoparticles bound to the substrate with a second type of nanoparticles having oligonucleotides attached to them that have a sequence complementary to the oligonucleotides on the first type of nanoparticles. The contacting will take place under conditions effective so that the oligonucleotides on the second type of nanoparticle hybridize to those on the first type of oligonucleotides. If needed, or

30 desired, additional layers of nanoparticles can be built up by alternately adding the first and second types of nanoparticles until a sufficient number of nanoparticles are

attached to the substrate to close the circuit. Another alternative to building up individual layers of nanoparticles would be the use of an aggregate probe (see above). As discussed herein, any other material well known in the art for closing circuits and thus establishing electrical contact between the electrodes may be used including including silver, gold, other conductive materials or any scheme or material that can catalyze the local aggrandization of material that can conduct electricity. The presence of the closed circuit can be detected by any suitable means such as a change in the electrical property of the electrodes such as the detectable change in conductivity.

10           The invention also provides kits for detecting nucleic acids. In one embodiment, the kit comprises at least one container, the container holding at least two types of nanoparticles having oligonucleotides attached thereto. The oligonucleotides on the first type of nanoparticles have a sequence complementary to the sequence of a first portion of a nucleic acid. The oligonucleotides on the second  
15           type of nanoparticles have a sequence complementary to the sequence of a second portion of the nucleic acid. The container may further comprise filler oligonucleotides having a sequence complementary to a third portion of the nucleic acid, the third portion being located between the first and second portions. The filler oligonucleotide may also be provided in a separate container.

20           In a second embodiment, the kit comprises at least two containers. The first container holds nanoparticles having oligonucleotides attached thereto which have a sequence complementary to the sequence of a first portion of a nucleic acid. The second container holds nanoparticles having oligonucleotides attached thereto which have a sequence complementary to the sequence of a second portion of the nucleic  
25           acid. The kit may further comprise a third container holding a filler oligonucleotide having a sequence complementary to a third portion of the nucleic acid, the third portion being located between the first and second portions.

          In another alternative embodiment, the kits can have the oligonucleotides and nanoparticles in separate containers, and the oligonucleotides would have to be  
30           attached to the nanoparticles prior to performing an assay to detect a nucleic acid. The oligonucleotides and/or the nanoparticles may be functionalized so that the

oligonucleotides can be attached to the nanoparticles. Alternatively, the oligonucleotides and/or nanoparticles may be provided in the kit without functional groups, in which case they must be functionalized prior to performing the assay.

In another embodiment, the kit comprises at least one container. The  
5 container holds metallic or semiconductor nanoparticles having oligonucleotides attached thereto. The oligonucleotides have a sequence complementary to a portion of a nucleic acid and have fluorescent molecules attached to the ends of the oligonucleotides not attached to the nanoparticles.

In yet another embodiment, the kit comprises a substrate, the substrate having  
10 attached thereto nanoparticles. The nanoparticles have oligonucleotides attached thereto which have a sequence complementary to the sequence of a first portion of a nucleic acid. The kit also includes a first container holding nanoparticles having oligonucleotides attached thereto which have a sequence complementary to the sequence of a second portion of the nucleic acid. The oligonucleotides may have the  
15 same or different sequences, but each of the oligonucleotides has a sequence complementary to a portion of the nucleic acid. The kit further includes a second container holding a binding oligonucleotide having a selected sequence having at least two portions, the first portion being complementary to at least a portion of the sequence of the oligonucleotides on the nanoparticles in the first container. The kit  
20 also includes a third container holding nanoparticles having oligonucleotides attached thereto, the oligonucleotides having a sequence complementary to the sequence of a second portion of the binding oligonucleotide.

In another embodiment, the kit comprises a substrate having oligonucleotides  
attached thereto which have a sequence complementary to the sequence of a first  
25 portion of a nucleic acid. The kit also includes a first container holding nanoparticles having oligonucleotides attached thereto which have a sequence complementary to the sequence of a second portion of the nucleic acid. The oligonucleotides may have the same or different sequences, but each of the oligonucleotides has a sequence complementary to a portion of the nucleic acid. The kit further includes a second  
30 container holding nanoparticles having oligonucleotides attached thereto which have a

sequence complementary to at least a portion of the oligonucleotides attached to the nanoparticles in the first container.

In yet another embodiment, the kits can have the substrate, oligonucleotides and nanoparticles in separate containers. The substrate, oligonucleotides, and nanoparticles would have to be appropriately attached to each other prior to performing an assay to detect a nucleic acid. The substrate, oligonucleotides and/or the nanoparticles may be functionalized to expedite this attachment. Alternatively, the substrate, oligonucleotides and/or nanoparticles may be provided in the kit without functional groups, in which case they must be functionalized prior to performing the assay.

In a further embodiment, the kit comprises a substrate having oligonucleotides attached thereto which have a sequence complementary to the sequence of a first portion of a nucleic acid. The kit also includes a first container holding liposomes having oligonucleotides attached thereto which have a sequence complementary to the sequence of a second portion of the nucleic acid and a second container holding nanoparticles having at least a first type of oligonucleotides attached thereto, the first type of oligonucleotides having a cholesteryl group attached to the end not attached to the nanoparticles so that the nanoparticles can attach to the liposomes by hydrophobic interactions. The kit may further comprise a third container holding a second type of nanoparticles having oligonucleotides attached thereto, the oligonucleotides having a sequence complementary to at least a portion of the sequence of a second type of oligonucleotides attached to the first type of nanoparticles. The second type of oligonucleotides attached to the first type of nanoparticles having a sequence complementary to the sequence of the oligonucleotides on the second type of nanoparticles.

In another embodiment, the kit may comprise a substrate having nanoparticles attached to it. The nanoparticles have oligonucleotides attached to them which have a sequence complementary to the sequence of a first portion of a nucleic acid. The kit also includes a first container holding an aggregate probe. The aggregated probe comprises at least two types of nanoparticles having oligonucleotides attached to them. The nanoparticles of the aggregate probe are bound to each other as a result of

the hybridization of some of the oligonucleotides attached to each of them. At least one of the types of nanoparticles of the aggregate probe has oligonucleotides attached to it which have a sequence complementary to a second portion of the sequence of the nucleic acid.

5           In yet another embodiment, the kit may comprise a substrate having oligonucleotides attached to it. The oligonucleotides have a sequence complementary to the sequence of a first portion of a nucleic acid. The kit further includes a first container holding an aggregate probe. The aggregate probe comprises at least two types of nanoparticles having oligonucleotides attached to them. The nanoparticles of  
10 the aggregate probe are bound to each other as a result of the hybridization of some of the oligonucleotides attached to each of them. At least one of the types of nanoparticles of the aggregate probe has oligonucleotides attached thereto which have a sequence complementary to a second portion of the sequence of the nucleic acid.

          In an additional embodiment, the kit may comprise a substrate having  
15 oligonucleotides attached to it and a first container holding an aggregate probe. The aggregate probe comprises at least two types of nanoparticles having oligonucleotides attached to them. The nanoparticles of the aggregate probe are bound to each other as a result of the hybridization of some of the oligonucleotides attached to each of them. At least one of the types of nanoparticles of the aggregate probe has oligonucleotides  
20 attached to it which have a sequence complementary to a first portion of the sequence of the nucleic acid. The kit also includes a second container holding nanoparticles. The nanoparticles have at least two types of oligonucleotides attached to them. The first type of oligonucleotides has a sequence complementary to a second portion of the sequence of the nucleic acid. The second type of oligonucleotides has a sequence  
25 complementary to at least a portion of the sequence of the oligonucleotides attached to the substrate.

          In another embodiment, the kit may comprise a substrate which has oligonucleotides attached to it. The oligonucleotides have a sequence complementary to the sequence of a first portion of a nucleic acid. The kit also comprises a first  
30 container holding liposomes having oligonucleotides attached to them. The oligonucleotides have a sequence complementary to the sequence of a second portion

of the nucleic acid. The kit further includes a second container holding an aggregate probe comprising at least two types of nanoparticles having oligonucleotides attached to them. The nanoparticles of the aggregate probe are bound to each other as a result of the hybridization of some of the oligonucleotides attached to each of them. At least  
5 one of the types of nanoparticles of the aggregate probe has oligonucleotides attached to it which have a hydrophobic groups attached to the ends not attached to the nanoparticles.

In a further embodiment, the kit may comprise a first container holding nanoparticles having oligonucleotides attached thereto. The kit also includes one or  
10 more additional containers, each container holding a binding oligonucleotide. Each binding oligonucleotide has a first portion which has a sequence complementary to at least a portion of the sequence of oligonucleotides on the nanoparticles and a second portion which has a sequence complementary to the sequence of a portion of a nucleic acid to be detected. The sequences of the second portions of the binding  
15 oligonucleotides may be different as long as each sequence is complementary to a portion of the sequence of the nucleic acid to be detected. In another embodiment, the kit comprises a container holding one type of nanoparticles having oligonucleotides attached thereto and one or more types of binding oligonucleotides. Each of the types of binding oligonucleotides has a sequence comprising at least two  
20 portions. The first portion is complementary to the sequence of the oligonucleotides on the nanoparticles, whereby the binding oligonucleotides are hybridized to the oligonucleotides on the nanoparticles in the container(s). The second portion is complementary to the sequence of a portion of the nucleic acid.

In another embodiment, kits may comprise one or two containers holding two  
25 types of particles. The first type of particles having oligonucleotides attached thereto which have a sequence complementary to the sequence of a first portion of a nucleic acid. The oligonucleotides are labeled with an energy donor on the ends not attached to the particles. The second type of particles having oligonucleotides attached thereto which have a sequence complementary to the sequence of a second portion of a  
30 nucleic acid. The oligonucleotides are labeled with an energy acceptor on the ends

not attached to the particles. The energy donors and acceptors may be fluorescent molecules.

In a further embodiment, the kit comprises a first container holding a type of latex microspheres having oligonucleotides attached thereto. The oligonucleotides  
5 have a sequence complementary to a first portion of the sequence of a nucleic acid and are labeled with a fluorescent molecule. The kit also comprises a second container holding a type of gold nanoparticles having oligonucleotides attached thereto. These oligonucleotides have a sequence complementary to a second portion of the sequence of the nucleic acid.

10 In another embodiment, the kit comprises a first container holding a first type of metallic or semiconductor nanoparticles having oligonucleotides attached thereto. The oligonucleotides have a sequence complementary to a first portion of the sequence of a nucleic acid and are labeled with a fluorescent molecule. The kit also comprises a second container holding a second type of metallic or semiconductor  
15 nanoparticles having oligonucleotides attached thereto. These oligonucleotides have a sequence complementary to a second portion of the sequence of a nucleic acid and are labeled with a fluorescent molecule.

In a further embodiment, the kit comprises a container holding a satellite probe. The satellite probe comprises a particle having attached thereto  
20 oligonucleotides. The oligonucleotides have a first portion and a second portion, both portions having sequences complementary to portions of the sequence of a nucleic acid. The satellite probe also comprises probe oligonucleotides hybridized to the oligonucleotides attached to the nanoparticles. The probe oligonucleotides have a first portion and a second portion. The first portion has a sequence complementary to  
25 the sequence of the first portion of the oligonucleotides attached to the particles, and both portions have sequences complementary to portions of the sequence of the nucleic acid. The probe oligonucleotides also have a reporter molecule attached to one end.

In another embodiment, the kit may comprise a container holding an aggregate  
30 probe. The aggregate probe comprises at least two types of nanoparticles having oligonucleotides attached to them. The nanoparticles of the aggregate probe are



bound to each other as a result of the hybridization of some of the oligonucleotides attached to each of them. At least one of the types of nanoparticles of the aggregate probe has oligonucleotides attached to it which have a sequence complementary to a portion of the sequence of a nucleic acid.

5           In an additional embodiment, the kit may comprise a container holding an aggregate probe. The aggregate probe comprises at least two types of nanoparticles having oligonucleotides attached to them. The nanoparticles of the aggregate probe are bound to each other as a result of the hybridization of some of the oligonucleotides attached to each of them. At least one of the types of nanoparticles  
10 of the aggregate probe has oligonucleotides attached to it which have a hydrophobic group attached to the end not attached to the nanoparticles.

          In yet another embodiment, the invention provides a kit comprising a substrate having located thereon at least one pair of electrodes with oligonucleotides attached to the substrate between the electrodes. In a preferred embodiment, the substrate has a  
15 plurality of pairs of electrodes attached to it in an array to allow for the detection of multiple portions of a single nucleic acid, the detection of multiple different nucleic acids, or both.

          The kits may also contain other reagents and items useful for detecting nucleic acid. The reagents may include PCR reagents, reagents for silver staining,  
20 hybridization reagents, buffers, etc. Other items which may be provided as part of the kit include a solid surface (for visualizing hybridization) such as a TLC silica plate, microporous materials, syringes, pipettes, cuvettes, containers, and a thermocycler (for controlling hybridization and de-hybridization temperatures). Reagents for functionalizing the nucleotides or nanoparticles may also be included in the kit.

25           The precipitation of aggregated nanoparticles provides a means of separating a selected nucleic acid from other nucleic acids. This separation may be used as a step in the purification of the nucleic acid. Hybridization conditions are those described above for detecting a nucleic acid. If the temperature is below the  $T_m$  (the temperature at which one-half of an oligonucleotide is bound to its complementary  
30 strand) for the binding of the oligonucleotides on the nanoparticles to the nucleic acid, then sufficient time is needed for the aggregate to settle. The temperature of

hybridization (e.g., as measured by  $T_m$ ) varies with the type of salt (NaCl or  $MgCl_2$ ) and its concentration. Salt compositions and concentrations are selected to promote hybridization of the oligonucleotides on the nanoparticles to the nucleic acid at convenient working temperatures without inducing aggregation of the colloids in the absence of the nucleic acid.

The invention also provides a method of nanofabrication. The method comprises providing at least one type of linking oligonucleotide having a selected sequence. A linking oligonucleotide used for nanofabrication may have any desired sequence and may be single-stranded or double-stranded. It may also contain chemical modifications in the base, sugar, or backbone sections. The sequences chosen for the linking oligonucleotides and their lengths and strandedness will contribute to the rigidity or flexibility of the resulting nanomaterial or nanostructure, or a portion of the nanomaterial or nanostructure. The use of a single type of linking oligonucleotide, as well as mixtures of two or more different types of linking oligonucleotides, is contemplated. The number of different linking oligonucleotides used and their lengths will contribute to the shapes, pore sizes and other structural features of the resulting nanomaterials and nanostructures.

The sequence of a linking oligonucleotide will have at least a first portion and a second portion for binding to oligonucleotides on nanoparticles. The first, second or more binding portions of the linking oligonucleotide may have the same or different sequences.

If all of the binding portions of a linking oligonucleotide have the same sequence, only a single type of nanoparticle with oligonucleotides having a complementary sequence attached thereto need be used to form a nanomaterial or nanostructure. If the two or more binding portions of a linking oligonucleotide have different sequences, then two or more nanoparticle-oligonucleotide conjugates must be used. *See, e.g.,* Figure 17. The oligonucleotides on each of the nanoparticles will have a sequence complementary to one of the two or more binding portions of the sequence of the linking oligonucleotide. The number, sequence(s) and length(s) of the binding portions and the distance(s), if any, between them will contribute to the structural and physical properties of the resulting nanomaterials and nanostructures.

Of course, if the linking oligonucleotide comprises two or more portions, the sequences of the binding portions must be chosen so that they are not complementary to each other to avoid having one portion of the linking nucleotide bind to another portion.

5           The linking oligonucleotides and nanoparticle-oligonucleotide conjugates are contacted under conditions effective for hybridization of the oligonucleotides attached to the nanoparticles with the linking oligonucleotides so that a desired nanomaterial or nanostructure is formed wherein the nanoparticles are held together by oligonucleotide connectors. These hybridization conditions are well known in the art  
10 and can be optimized for a particular nanofabrication scheme (see above). Stringent hybridization conditions are preferred.

          The invention also provides another method of nanofabrication. This method comprises providing at least two types of nanoparticle-oligonucleotide conjugates. The oligonucleotides on the first type of nanoparticles have a sequence  
15 complementary to that of the oligonucleotides on the second type of nanoparticles. The oligonucleotides on the second type of nanoparticles have a sequence complementary to that of the oligonucleotides on the first type of nanoparticles. The nanoparticle-oligonucleotide conjugates are contacted under conditions effective to allow hybridization of the oligonucleotides on the nanoparticles to each other so that a  
20 desired nanomaterial or nanostructure is formed wherein the nanoparticles are held together by oligonucleotide connectors. Again, these hybridization conditions are well-known in the art and can be optimized for a particular nanofabrication scheme.

          In both nanofabrication methods of the invention, the use of nanoparticles having one or more different types of oligonucleotides attached thereto is  
25 contemplated. The number of different oligonucleotides attached to a nanoparticle and the lengths and sequences of the one or more oligonucleotides will contribute to the rigidity and structural features of the resulting nanomaterials and nanostructures.

          Also, the size, shape and chemical composition of the nanoparticles will contribute to the properties of the resulting nanomaterials and nanostructures. These  
30 properties include optical properties, optoelectronic properties, electrochemical properties, electronic properties, stability in various solutions, pore and channel size

variation, ability to separate bioactive molecules while acting as a filter, etc. The use of mixtures of nanoparticles having different sizes, shapes and/or chemical compositions, as well as the use of nanoparticles having uniform sizes, shapes and chemical composition, are contemplated.

5           In either fabrication method, the nanoparticles in the resulting nanomaterial or nanostructure are held together by oligonucleotide connectors. The sequences, lengths, and strandedness of the oligonucleotide connectors, and the number of different oligonucleotide connectors present will contribute to the rigidity and structural properties of the nanomaterial or nanostructure. If an oligonucleotide  
10 connector is partially double-stranded, its rigidity can be increased by the use of a filler oligonucleotide as described above in connection with the method of detecting nucleic acid. The rigidity of a completely double-stranded oligonucleotide connector can be increased by the use of one or more reinforcing oligonucleotides having complementary sequences so that they bind to the double-stranded oligonucleotide  
15 connector to form triple-stranded oligonucleotide connectors. The use of quadruple-stranded oligonucleotide connectors based on deoxyquanosine or deoxycytidine quartets is also contemplated.

Several of a variety of systems for organizing nanoparticles based on oligonucleotide hybridization are illustrated in the figures. In a simple system (Figure  
20 1) one set of nanoparticles bears oligonucleotides with a defined sequence and another set of nanoparticles bears oligonucleotides with a complementary sequence. On mixing the two sets of nanoparticle-oligonucleotide conjugates under hybridization conditions, the two types of particles are linked by double stranded oligonucleotide connectors which serve as spacers to position the nanoparticles at selected distances.

25           An attractive system for spacing nanoparticles involves the addition of one free linking oligonucleotide as illustrated in Figure 2. The sequence of the linking oligonucleotide will have at least a first portion and a second portion for binding to oligonucleotides on nanoparticles. This system is basically the same as utilized in the nucleic acid detection method, except that the length of the added linking  
30 oligonucleotide can be selected to be equal to the combined lengths of oligonucleotides attached to the nanoparticles. The related system illustrated in

Figure 3 provides a convenient means to tailor the distance between nanoparticles without having to change the sets of nanoparticle-oligonucleotide conjugates employed.

A further elaboration of the scheme for creating defined spaces between nanoparticles is illustrated in Figure 4. In this case a double stranded segment of DNA or RNA containing overhanging ends is employed as the linking oligonucleotide. Hybridization of the single-stranded, overhanging segments of the linking oligonucleotide with the oligonucleotides attached to the nanoparticles affords multiple double-stranded oligonucleotide cross-links between the nanoparticles.

Stiffer nanomaterials and nanostructures, or portions thereof, can be generated by employing triple-stranded oligonucleotide connectors between nanoparticles. In forming the triple strand, one may exploit either the pyrimidine:purine:pyrimidine motif (Moser, H.E. and Dervan, P.B. *Science*, **238**, 645-650 (1987) or the purine:purine:pyrimidine motif (Pilch, D.S. et al. *Biochemistry*, **30**, 6081-6087 (1991).

An example of the organization of nanoparticles by generating triple-stranded connectors by the pyrimidine:purine:pyrimidine motif are illustrated in Figure 10. In the system shown in Figure 10, one set of nanoparticles is conjugated with a defined strand containing pyrimidine nucleotides and the other set is conjugated with a complementary oligonucleotide containing purine nucleotides. Attachment of the oligonucleotides is designed such that the nanoparticles are separated by the double-stranded oligonucleotide formed on hybridization. Then, a free pyrimidine oligonucleotide with an orientation opposite that for the pyrimidine strand linked to the nanoparticle is added to the system prior to, simultaneously with, or just subsequent to mixing the nanoparticles. Since the third strand in this system is held by Hoogsteen base pairing, the triple strand is relatively unstable thermally. Covalent bridges spanning the breadth of the duplex are known to stabilize triple-stranded complexes (Salunke, M., Wu, T., Letsinger, R.L., *J. Am. Chem. Soc.* **114**, 8768-8772, (1992). Letsinger, R.L. and Wu, T. *J. Am. Chem. Soc.*, **117**, 7323-7328 (1995). Prakash, G. and Kool, *J. Am. Chem. Soc.*, **114**, 3523-3527 (1992).

For construction of nanomaterials and nanostructures, it may be desirable in some cases to "lock" the assembly in place by covalent cross-links after formation of

the nanomaterial or nanostructure by hybridization of the oligonucleotide components. This can be accomplished by incorporating functional groups that undergo a triggered irreversible reaction into the oligonucleotides. An example of a functional group for this purpose is a stilbenedicarboxamide group. It has been  
5 demonstrated that two stilbenedicarboxamide groups aligned within hybridized oligonucleotides readily undergo cross-linking on irradiation with ultraviolet light (340 nm) (Lewis, F.D. et al. (1995) *J Am. Chem. Soc.* 117, 8785-8792).

Alternatively, one could employ the displacement of a 5'-O-tosyl group from an oligonucleotide, held at the 3'-position to a nanoparticle by a mercaptoalkyl group,  
10 with a thiophosphoryl group at the 3'-end of an oligonucleotide held to a nanoparticle by a mercaptoalkyl group. In the presence of an oligonucleotide that hybridizes to both oligonucleotides and, thereby, brings the thiophosphoryl group into proximity of the tosyl group, the tosyl group will be displaced by the thiophosphoryl group, generating an oligonucleotide linked at the ends to two different nanoparticles.  
15 For displacement reactions of this type, see Herrlein et al., *J. Am. Chem. Soc.*, 117, 10151-10152 (1995). The fact that thiophosphoryl oligonucleotides do not react with gold nanoparticles under the conditions employed in attaching mercaptoalkyl-oligonucleotides to gold nanoparticles enables one to prepare gold nanoparticle-oligonucleotide conjugates anchored through the mercapto group to the nanoparticles  
20 and containing a terminal thiophosphoryl group free for the coupling reaction.

A related coupling reaction to lock the assembled nanoparticle system in place utilizes displacement of bromide from a terminal bromoacetylaminonucleoside by a terminal thiophosphoryl-oligonucleotide as described in Gryaznov and Letsinger, *J. Am. Chem. Soc.*, 115, 3808. This reaction proceeds much like the displacement of  
25 tosylate described above, except that the reaction is faster. Nanoparticles bearing oligonucleotides terminated with thiophosphoryl groups are prepared as described above. For preparation of nanoparticles bearing oligonucleotides terminated with bromoacetyl amino groups, one first prepares an oligonucleotide terminated at one end by an aminonucleoside (*e.g.*, either 5'-amino-5'-deoxythymidine or 3'-amino-3'-  
30 deoxythymidine) and at the other end by a mercaptoalkyl group. Molecules of this oligonucleotide are then anchored to the nanoparticles through the mercapto groups,

and the nanoparticle-oligonucleotide conjugate is then converted the N-bromoacetyl amino derivative by reaction with a bromoacetyl acylating agent.

A fourth coupling scheme to lock the assemblies in place utilizes oxidation of nanoparticles bearing oligonucleotides terminated by thiophosphoryl groups. Mild oxidizing agents, such as potassium triiodide, potassium ferricyanide (see Gryaznov and Letsinger, *Nucleic Acids Research*, 21, 1403) or oxygen, are preferred.

In addition, the properties of the nanomaterials and nanostructures can be altered by incorporating into the interconnecting oligonucleotide chains organic and inorganic functions that are held in place by covalent attachment to the oligonucleotide chains. A wide variety of backbone, base and sugar modifications are well known (see for example Uhlmann, E., and Peyman, A. *Chemical Reviews*, 90, 544-584 (1990). Also, the oligonucleotide chains could be replaced by "Peptide Nucleic Acid" chains (PNA), in which the nucleotide bases are held by a polypeptide backbone (see Wittung, P. et al., *Nature*, 368, 561-563 (1994).

As can be seen from the foregoing, the nanofabrication method of the invention is extremely versatile. By varying the length, sequence and strandedness of the linking oligonucleotides, the number, length, and sequence of the binding portions of the linking oligonucleotides, the length, sequence and number of the oligonucleotides attached to the nanoparticles, the size, shape and chemical composition of the nanoparticles, the number and types of different linking oligonucleotides and nanoparticles used, and the strandedness of the oligonucleotide connectors, nanomaterials and nanostructures having a wide range of structures and properties can be prepared. These structures and properties can be varied further by cross-linking of the oligonucleotide connectors, by functionalizing the oligonucleotides, by backbone, base or sugar modifications of the oligonucleotides, or by the use of peptide-nucleic acids.

The nanomaterials and nanostructures that can be made by the nanofabrication method of the invention include nanoscale mechanical devices, separation membranes, bio-filters, and biochips. It is contemplated that the nanomaterials and nanostructures of the invention can be used as chemical sensors, in computers, for drug delivery, for protein engineering, and as templates for biosynthesis/nanostructure

fabrication/directed assembly of other structures. See generally Seeman et al., *New J. Chem.*, 17, 739 (1993) for other possible applications. The nanomaterials and nanostructures that can be made by the nanofabrication method of the invention also can include electronic devices. Whether nucleic acids could transport electrons has  
5 been the subject of substantial controversy. As shown in Example 21 below, nanoparticles assembled by DNA conduct electricity (the DNA connectors function as semiconductors).

Finally, the invention provides methods of making unique nanoparticle-oligonucleotide conjugates. In the first such method, oligonucleotides are bound to  
10 charged nanoparticles to produce stable nanoparticle-oligonucleotide conjugates. Charged nanoparticles include nanoparticles made of metal, such as gold nanoparticles.

The method comprises providing oligonucleotides having covalently bound thereto a moiety comprising a functional group which can bind to the nanoparticles.  
15 The moieties and functional groups are those described above for binding (*i.e.*, by chemisorption or covalent bonding) oligonucleotides to nanoparticles. For instance, oligonucleotides having an alkanethiol, an alkanedisulfide or a cyclic disulfide covalently bound to their 5' or 3' ends can be used to bind the oligonucleotides to a variety of nanoparticles, including gold nanoparticles.

20 The oligonucleotides are contacted with the nanoparticles in water for a time sufficient to allow at least some of the oligonucleotides to bind to the nanoparticles by means of the functional groups. Such times can be determined empirically. For instance, it has been found that a time of about 12-24 hours gives good results. Other suitable conditions for binding of the oligonucleotides can also be determined  
25 empirically. For instance, a concentration of about 10-20 nM nanoparticles and incubation at room temperature gives good results.

Next, at least one salt is added to the water to form a salt solution. The salt can be any water-soluble salt. For instance, the salt may be sodium chloride, magnesium chloride, potassium chloride, ammonium chloride, sodium acetate,  
30 ammonium acetate, a combination of two or more of these salts, or one of these salts in phosphate buffer. Preferably, the salt is added as a concentrated solution, but it



could be added as a solid. The salt can be added to the water all at one time or the salt is added gradually over time. By "gradually over time" is meant that the salt is added in at least two portions at intervals spaced apart by a period of time. Suitable time intervals can be determined empirically.

5           The ionic strength of the salt solution must be sufficient to overcome at least partially the electrostatic repulsion of the oligonucleotides from each other and, either the electrostatic attraction of the negatively-charged oligonucleotides for positively-charged nanoparticles, or the electrostatic repulsion of the negatively-charged oligonucleotides from negatively-charged nanoparticles. Gradually reducing the  
10       electrostatic attraction and repulsion by adding the salt gradually over time has been found to give the highest surface density of oligonucleotides on the nanoparticles. Suitable ionic strengths can be determined empirically for each salt or combination of salts. A final concentration of sodium chloride of from about 0.1 M to about 1.0 M in phosphate buffer, preferably with the concentration of sodium chloride being  
15       increased gradually over time, has been found to give good results.

          After adding the salt, the oligonucleotides and nanoparticles are incubated in the salt solution for an additional period of time sufficient to allow sufficient additional oligonucleotides to bind to the nanoparticles to produce the stable nanoparticle-oligonucleotide conjugates. As will be described in detail below, an  
20       increased surface density of the oligonucleotides on the nanoparticles has been found to stabilize the conjugates. The time of this incubation can be determined empirically. A total incubation time of about 24-48, preferably 40 hours, has been found to give good results (this is the total time of incubation; as noted above, the salt concentration can be increased gradually over this total time). This second period of incubation in  
25       the salt solution is referred to herein as the "aging" step. Other suitable conditions for this "aging" step can also be determined empirically. For instance, incubation at room temperature and pH 7.0 gives good results.

          The conjugates produced by use of the "aging" step have been found to be considerably more stable than those produced without the "aging" step. As noted  
30       above, this increased stability is due to the increased density of the oligonucleotides on the surfaces of the nanoparticles which is achieved by the "aging" step. The

surface density achieved by the "aging" step will depend on the size and type of nanoparticles and on the length, sequence and concentration of the oligonucleotides. A surface density adequate to make the nanoparticles stable and the conditions necessary to obtain it for a desired combination of nanoparticles and oligonucleotides

5 can be determined empirically. Generally, a surface density of at least 10 picomoles/cm<sup>2</sup> will be adequate to provide stable nanoparticle-oligonucleotide conjugates. Preferably, the surface density is at least 15 picomoles/cm<sup>2</sup>. Since the ability of the oligonucleotides of the conjugates to hybridize with nucleic acid and oligonucleotide targets can be diminished if the surface density is too great, the

10 surface density is preferably no greater than about 35-40 picomoles/cm<sup>2</sup>.

As used herein, "stable" means that, for a period of at least six months after the conjugates are made, a majority of the oligonucleotides remain attached to the nanoparticles and the oligonucleotides are able to hybridize with nucleic acid and oligonucleotide targets under standard conditions encountered in methods of detecting

15 nucleic acid and methods of nanofabrication.

Aside from their stability, the nanoparticle-oligonucleotide conjugates made by this method exhibit other remarkable properties. See, *e.g.*, Examples 5, 7, and 19 of the present application. In particular, due to the high surface density of the conjugates, they will assemble into large aggregates in the presence of a target

20 nucleic acid or oligonucleotide. The temperature over which the aggregates form and dissociate has unexpectedly been found to be quite narrow, and this unique feature has important practical consequences. In particular, it increases the selectivity and sensitivity of the methods of detection of the present invention. A single base mismatch and as little as 20 femtomoles of target can be detected using the

25 conjugates. Although these features were originally discovered in assays performed in solution, the advantages of the use of these conjugates have been found to extend to assays performed on substrates, including those in which only a single type of conjugate is used.

It has been found that the hybridization efficiency of nanoparticle-oligonucleotide conjugates can be increased dramatically by the use of recognition oligonucleotides which comprise a recognition portion and a spacer portion.

30

“Recognition oligonucleotides” are oligonucleotides which comprise a sequence complementary to at least a portion of the sequence of a nucleic acid or oligonucleotide target. In this embodiment, the recognition oligonucleotides comprise a recognition portion and a spacer portion, and it is the recognition portion which hybridizes to the nucleic acid or oligonucleotide target. The spacer portion of the recognition oligonucleotide is designed so that it can bind to the nanoparticles. For instance, the spacer portion could have a moiety covalently bound to it, the moiety comprising a functional group which can bind to the nanoparticles. These are the same moieties and functional groups as described above. As a result of the binding of the spacer portion of the recognition oligonucleotide to the nanoparticles, the recognition portion is spaced away from the surface of the nanoparticles and is more accessible for hybridization with its target. The length and sequence of the spacer portion providing good spacing of the recognition portion away from the nanoparticles can be determined empirically. It has been found that a spacer portion comprising at least about 10 nucleotides, preferably 10-30 nucleotides, gives good results. The spacer portion may have any sequence which does not interfere with the ability of the recognition oligonucleotides to become bound to the nanoparticles or to a nucleic acid or oligonucleotide target. For instance, the spacer portions should not be sequences complementary to each other, to that of the recognition oligonucleotides, or to that of the nucleic acid or oligonucleotide target of the recognition oligonucleotides. Preferably, the bases of the nucleotides of the spacer portion are all adenines, all thymines, all cytidines, or all guanines, unless this would cause one of the problems just mentioned. More preferably, the bases are all adenines or all thymines. Most preferably the bases are all thymines.

It has further been found that the use of diluent oligonucleotides in addition to recognition oligonucleotides provides a means of tailoring the conjugates to give a desired level of hybridization. The diluent and recognition oligonucleotides have been found to attach to the nanoparticles in about the same proportion as their ratio in the solution contacted with the nanoparticles to prepare the conjugates. Thus, the ratio of the diluent to recognition oligonucleotides bound to the nanoparticles can be controlled so that the conjugates will participate in a desired number of hybridization

events. The diluent oligonucleotides may have any sequence which does not interfere with the ability of the recognition oligonucleotides to be bound to the nanoparticles or to bind to a nucleic acid or oligonucleotide target. For instance, the diluent oligonucleotides should not have a sequence complementary to that of the recognition oligonucleotides or to that of the nucleic acid or oligonucleotide target of the recognition oligonucleotides. The diluent oligonucleotides are also preferably of a length shorter than that of the recognition oligonucleotides so that the recognition oligonucleotides can bind to their nucleic acid or oligonucleotide targets. If the recognition oligonucleotides comprise spacer portions, the diluent oligonucleotides are, most preferably, about the same length as the spacer portions. In this manner, the diluent oligonucleotides do not interfere with the ability of the recognition portions of the recognition oligonucleotides to hybridize with nucleic acid or oligonucleotide targets. Even more preferably, the diluent oligonucleotides have the same sequence as the sequence of the spacer portions of the recognition oligonucleotides.

Protein receptors and other specific binding pair members can be functionalized with oligonucleotides and immobilized onto oligonucleotide-modified nanoparticles to generate a new class of hybrid particles (nanoparticle-receptor conjugates) that exhibit the high stability of the oligonucleotide modified particles but with molecular recognition properties that are dictated by the protein receptor rather than DNA. Alternatively, one could functionalize a protein that has multiple receptor binding sites with receptor-modified oligonucleotides so that the protein receptor complex could be used as one of the building blocks, in place of one of the inorganic nanoparticles, in the original nanomaterials assembly scheme discussed above. The use of these novel nanoparticle-receptor conjugates in analyte detection strategies have been evaluated in a number of ways including identification of targets and screening for protein-protein interactions.

In one embodiment of the invention, novel hybrid particles or nanoparticle-receptor conjugates that are stable in a wide range of aqueous salt concentrations, have a long shelf life, and enable use of proteins that are poorly soluble in water as well as those of high water solubility are provided. The probe system (see representative Construct II, Figure 47) can be used to screen an array of proteins

immobilized at discrete positions on a surface (Figure 48). The same principles for probe construction and application can be adapted for studying a great variety of specific binding reactions involving combinations of specific binding pair members such as proteins, peptides, carbohydrates, sugars, oligo- and polynucleotides, and small molecules (Figure 49, where A and B can be a protein, peptide, carbohydrate, sugar, oligo- or polynucleotide, synthetic polymer or oligomer, or a small molecule and any combination thereof). The basic concept is to attach a "receptor unit" (A in Figure 49) to an oligonucleotide which is complementary to oligonucleotides bound to the nanoparticle. Hybridization then generates a nanoparticle probe containing a sheath of oligonucleotides around the nanoparticle matrix which serves to enhance water solubility of the system and to stabilize the colloids with respect to aggregation. Probe II' is then used to interrogate a target (B) immobilized on a solid surface. Binding of A to B is monitored by detection of the nanoparticles bound to the solid-surface (e.g. colorimetrically, by fluorescence, silver staining, etc.). This scheme can be used for any molecules wherein A can be conjugated to an oligonucleotide and B can be immobilized on a surface.

An example of the invention is illustrated in Figure 47, where I is a gold nanoparticle bearing a large number of oligonucleotides linked firmly to the gold surface (e.g. via a sulfur-gold bond) and 1 is a protein containing a pendant oligonucleotide with a sequence complementary to the sequence for the oligonucleotides attached to the nanoparticle. Procedures for constructing nanoparticle-oligonucleotide conjugates having a high surface density of oligonucleotides are described herein. See for instance Example 3 and C. A. Mirkin et al. *Nature*, 382, 607-609 (1996); R. Elghanian et al., *Science*, 277, 1078-1081 (1997); J. J. Storhoff et al., *J. Am. Chem. Soc.* 120, 1959-1964 (1998). Methods for conjugating oligonucleotides to proteins are well known; details for one method were described by E. R. Hendrickson, et al. *Nucleic Acids Research*, 23, 522-529 (1995). When the oligonucleotides conjugated to the nanoparticles and the oligonucleotide-protein conjugate are brought together under conditions for hybridization, one or more of the oligonucleotide-protein conjugate molecules will bind to a given nanoparticle by hybridization to produce a nanoparticle protein conjugate. See Figures 47 and

50(a). An alternative embodiment of the nanoparticle receptor conjugate is shown in Figure 50(b) which entails the use of a linking oligonucleotide that brings the nanoparticle-oligonucleotide constructs and oligonucleotide-protein conjugate together under conditions for hybridization. In this embodiment, the linker  
5 oligonucleotide has one segment (a') complementary to oligonucleotide (a) bound to the nanoparticle and another segment (b') complementary to oligonucleotide (b) bound to the receptor.

The resulting nanoparticle-protein complexes can be separated from unbound protein by centrifugation or gel filtration, and used as probes for target analytes such as antigens. Figure 51 illustrates a number of representative detection schemes that  
10 can employ the nanoparticle-protein conjugates as a probe. The nanoparticle-protein conjugates have a wide variety of applications including identifying target analytes, screening a library of molecules such as drugs immobilized in array onto a support (Figure 51(a)) or in histochemical applications to identify for the presence of analytes  
15 in cells or tissues. The probe can also be used in a spot test where the analyte, e.g., protein or drug, has multiple binding sites.

The gold probe-receptor-ligand target combinations resulting from these assays can be observed by visually (e.g., spot test or formation of aggregates or silver staining) or by any known procedure. For instance, the nanoparticle-protein  
20 conjugate system can be used to develop a colorimetric test for nucleic acids, which relies on the aggregate properties of the nanoparticle/DNA/protein composite, Figure 52 (A). In a typical experiment, solutions of a complex comprised of streptavidin bound to four biotin-oligonucleotide conjugates (1-STV) and a gold nanoparticle  
DNA conjugate (2-Au) with and without target nucleic acid (3) were prepared. The  
25 sequence of the target nucleic acid has two portions. The oligonucleotides bound to the complex is complementary to the first portion of the nucleic acid while the oligonucleotides bound to the nanoparticles are complementary to the second part of the nucleic acid. The solutions were heated to 53 °C for 30 min, and then 3  $\mu$ L  
aliquots of the solutions were spotted on a C18 reverse-phase thin-layer  
30 chromatography plate. The solution with target nucleic acid showed a blue spot and the solution without target showed a red spot. This result and the sharp melting curve

demonstrate that one of the gold nanoparticle probes in the above-described spot test (Figure 52 (B)) can be replaced by streptavidin/DNA conjugates, which are simpler to prepare than gold probes.

The system shown in 52(a) can also be used to prepare novel 3-dimensional  
5 nanomaterials or assemblies as discussed above. In a simple variation of Figure 52(a), as shown in Figure 52(c), no linking oligonucleotides are used and the oligonucleotide attached to the complex are complementary to the oligonucleotides bound to the nanoparticles.

These new nanoparticle-protein probes (II) have unique features which  
10 provide significant advantages over the previously describe nanoparticle protein conjugates. In particular, the high density oligonucleotides on the surface of the nanoparticles function as a polyanionic sheath to enhance solubility and stability of the nanoparticles-protein conjugates in water over a very wide range of solubility and stability of the nanoparticles-protein conjugates in water over a very wide range of  
15 salt concentrations. Also, the reversibility of the oligonucleotide-oligonucleotide binding provides an extra means for characterizing the complex that is formed with the target. In addition, the nanoparticle-proteins are more resistant to non-specific binding (see Figure 53).

While the preferred nanoparticle-protein complexes are based on gold  
20 nanoparticles, other particles based on a wide variety of other materials (e.g., silver, platinum, mixtures of gold and silver, magnetic particles, semiconductors, quantum dots) can be used, and the particle sizes may range from 2-100 nm as described above. U.S. Patent application Serial No. 09/344,667 and PCT application WO 98/04740, both of which are incorporated herein by reference in their entirety, describe suitable  
25 nanoparticles and methods of attaching oligonucleotides to them.

In another embodiment, the nanoparticle-oligonucleotide-protein complexes (II) are employed as probes in detecting specific target molecules such as proteins immobilized on a smooth surface. See, for instance, Figures 48, 49 51 and 54. For this purpose, a number of different proteins may be immobilized at different discrete  
30 spots as array on a glass slide. A number of linkage methods may be used. One method, well known in the art, is to treat the glass with 3-aminopropyltriethoxysilane

followed by 1,4-phenylene diisothiocyanate. This sequence generates a surface holding pendant isothiocyanate groups that can be used to bind substances containing one or more amino groups. Targets containing amino groups can be immobilized directly onto this modified surface. For other substances, an aminoalkyl group can be

5 tethered to the target to provide the necessary reactive group. Following immobilization of the target on the surface, deactivation of residual isothiocyanate groups, and washing, the surface is exposed to a colloidal solution of II. Another method for immobilizing proteins involving "printing" proteins onto glass slides having bound aldehyde groups to produce protein chips. G. MacBeath et al., *Science*, 10 289, 1760-1763 (2000); *Nature*, 2000, 405, 837; and *Anal. Biochem.*, 278, 123, all incorporated by reference in their entirety. The amino groups on the proteins react to form covalent bonds without significant disruption of the three dimensional structure of the protein so the proteins can still react with receptors and other targeting molecules. Alternatively, the specific target molecules or analytes can be bound to

15 oligonucleotides to form oligonucleotide-analyte conjugates where the oligonucleotides bound to the analytes have a sequence that is complementary to the sequence of oligonucleotides bound to a support. There are numerous methods for covalently linking proteins and other substances onto oligonucleotides. One method involves the use of SMPB (sulfosuccinimidyl 4-[p-maleimidophenyl]butyrate) to

20 couple thiol-modified oligonucleotide and streptavidin. *Nucleic Acids Research*, 1994, 22, 5530, incorporated by reference in its entirety. By contacting the oligonucleotides bound to the support with the oligonucleotides bound to the analyte under hybridization conditions, the analyte may be bound to the support.

The probe is then contacted with the support. After sufficient time for the

25 protein-protein specific binding interaction to occur, the excess nanoparticle conjugates are washed away and the nanoparticles are detected. The metallic nanoparticles may be detected directly by their color or as gray spots following silver staining. Hence, specific protein/receptor binding interactions may be exploited as a way of indicating the presence of one or the other on a glass slide (Figure 54). In a

30 typical experiment, biotinylated DNA hybridized to one portion of a glass slide with complementary DNA could be probed by exposing the glass slide to a solution



containing streptavidin bound to biotinylated DNA hybridized to our high DNA density gold nanoparticle probes described herein. The probes bind to the portion of the slide with biotin. The signal associated with the complexed probes could be further developed by treating with silver enhancing solution (see Figure 54).

5           As pointed out above, useful probes of type II can be made using a great variety of substances as the functional recognition elements. The scheme for synthesis and application of the probes, shown in Figures 49 and 50, is completely analogous to that presented in Figure 48 for studying protein-protein interactions. For the general case in Figure 49, the conjugate probe is designated II', the receptor unit  
10 as A, and the target immobilized on the solid surface as B. The system in Figure 48 and variations described herein is a special case of the general system shown in Figure 49.

          In some cases, it may be preferable to use oligonucleotide-nanoparticle probes of type II that are constructed from non-metal nanoparticles. Type II probes based on  
15 inherently fluorescent nanoparticles may be observed by their fluorescence. Other nanoparticles can be made fluorescent by appending fluorescent tags to the particles either before or after the oligonucleotide sheath has been added.

          In another embodiment of the invention, a novel protein detection method is provided. Protein binding molecules are joined to gold nanoparticle-oligonucleotide  
20 conjugates through a linking oligonucleotide where the linking DNA can be used as a marker for the specific protein. Figure 55 describes a protein detection method utilizing the linking oligonucleotide as reporter DNA. In this method, oligonucleotides are modified with protein binding molecules in a way such that each protein molecule has a different oligonucleotide sequence, and then the protein-  
25 oligonucleotide conjugates are immobilized on Au particles as a result of hybridization. For example, biotinylated DNA can be immobilized on gold nanoparticle-oligonucleotide conjugates to generate biotin nanoparticle conjugates. In the presence of streptavidin, the biotin modified nanoparticles will form aggregates and the aggregates can be easily separated from other particles. The aggregates are  
30 then disassembled by DNA dehybridization, and the reporter DNA is isolated from Au particles and proteins. Since each protein binding molecule has a unique DNA

sequence, the protein can be identified by well established DNA detection methods such as the use of a DNA chip. Once the reporter DNA is isolated, the detection limit can be very low because the reporter DNA can be amplified by PCR.

A common feature of all these nanoparticle-oligonucleotide-receptor  
5 conjugate systems is that the signal for interaction of the components being tested, e.g. receptor A and B in Figure 49, depends both on A binding to B and on the interaction of oligonucleotide a with oligonucleotide a'. Since the dissociation temperature for the oligonucleotide duplex segment can be tuned by controlling the length and sequence of the complementary strands and the salt concentration, one can  
10 in many cases design systems such that the oligonucleotide duplexes will dissociate at a lower temperature, or a higher temperature, than the components being tested, according to the wishes of the investigator. As discussed herein, complexes formed by hybridization of oligonucleotide gold nanoparticle probes with oligonucleotides linked to other nanoparticles or to a glass surface dissociate over an unusually narrow  
15 temperature range. To our knowledge, such sharp melting transitions are unprecedented for complexes derived from oligonucleotides of this size. This property sets these nanoparticle oligonucleotide probes, I, in Figure 47, apart from other probe systems, including other probes based on nanoparticles and oligonucleotides. Accordingly, if one designs systems of type IV (Figure 48) or V  
20 (Figure 54) in such a way that the observed signal reflects dissociation of the oligonucleotide duplex, the dissociation transition will extremely sharp. This feature provides an extra dimension for characterizing the complexes of type IV and V. Alternatively, one can design the system to favor initial dissociation of A-B complex in order to obtain information on the strength of that interaction of A with B.

25 As can be readily appreciated, highly desirable nanoparticle-oligonucleotide conjugates can be prepared by employing all of the methods described above. By doing so, stable conjugates with tailored hybridization and specific binding abilities can be produced.

Any of the above conjugates can be, and are preferably, used in any of the  
30 methods of detecting analytes such as nucleic acids described above, and the invention also provides a kit comprising a container holding any of the above

conjugates. In addition, the conjugates can be, and are preferably, used in any of the methods of nanofabrication of the invention and the method of separating nucleic acids.

The invention also relates to the use of an electric field to facilitate  
5 hybridization of inventive nanoparticle-oligonucleotide conjugates to complementary oligonucleotides on an electrode surface. Now, in addition to salt, pH, temperature, chaotropic agents and other factors discussed above, the electric field strength (in particular the current level and density) can provide a precisely controllable and continuously variable parameter for adjustment of nucleic acid interactions. In  
10 addition to facilitating nucleic acid hybridization interactions, these electric fields can be extended to facilitate other interactions involving nanoparticle-charged molecule conjugates that include, but are not limited to, most molecular biological procedures, such as specific binding pair interactions, antibody/antigen reaction, cell separations, and related clinical diagnostics. The application of an electric field facilitates the  
15 design, fabrication and use of nanoparticle-based biosensors of various types for monitoring (or measure) the progress or occurrence of a selected biologic reaction. Biosensors are discussed in some detail in Protein immobilization, Fundamentals & Applications, R.F. Taylor, ed. (1991) (chapter 8); and Immobilized Affinity Ligand Techniques, Hermanson et al. (1992) (chapter 5). See also U.S. Patent No. 5,965,452  
20 and references cited therein.

Recently, Nanogen and others have developed microelectronic nucleic acid array methods and devices in that utilize electric fields as an independent parameter to control transport, hybridization and stringency of nucleic acid interactions. These are "active" array devices in that they exploit microelectronic as well as microfabrication  
25 technology. See, for instance, Edman et al., Nucleic Acids Res., 1997, Vol. 25 (24), 4907-14; U.S. Patent Nos. 6,051,380; 6,068,818; 5,929,208; 5,632,957; 5,565,322; 5,605,662; 5,849,486; 6,048,690; 6,013,166; and 5,965,452, which are incorporated by reference in their entirety. These references describe microelectronic based nucleic acid arrays that utilize electric fields as an independent parameter to control  
30 transport, hybridization and stringency of nucleic acid interactions. These are "active" array devices in that they exploit microelectronic as well as microfabrication

technology. Prior to the present invention, however, the Applicants believe that the art has not described or suggested that interactions between nanoparticle-first specific binding pair member conjugates and second binding pair member, e.g., such as hybridization interactions between nanoparticle-oligonucleotide conjugates and complementary nucleotides bound to a surface, can be facilitated with an electric field.

Combinatorial oligonucleotide array (or "gene chip") technology depends on the quantitative detection of target DNA hybridized to complementary array elements. We recently reported a "scanometric" method for detecting DNA targets hybridized to gene arrays in which oligonucleotide-functionalized, 13 nm diameter gold nanoparticles serve as the indicators of target hybridization to the chip. [Taton, T.A.; Mirkin, C.A.; Letsinger, R.L. *Science* 200, 289, 1757]. Because of the unusually sharp temperature-induced dissociation (or "melting") profiles of the nanoparticles from the surface of the array, the selectivity of the scanometric DNA detection system was intrinsically higher (by a factor of 4) than that of a conventional array system based upon fluorophore probes. In addition, enlarging the array-bound nanoparticles by gold-promoted reduction of silver (I) permitted the arrays to be imaged, in black-and-white by a flatbed optical scanner, with 100 times the sensitivity than that typically observed by confocal fluorescence imaging of fluorophore-labeled gene chips. The scanometric method was successfully used for DNA mismatch identification and shows promise for use in single nucleotide polymorphism analysis [Wang, D.G. et al. *Science* 1998, 280, 1077] or identification of genetic disease mutations [Hacia, J.G. *Nat. Genet.* 1999, 21, 42]. However, researchers interested in using gene chips for studying gene expression often require the additional capability of multicolor labeling and imaging of DNA microarrays to perform difference analysis of expressed mRNA in test and reference samples [Brown, P.O.; Botstein, D. *Nat. Genet.* 1999, 21, 33].

Metal nanoparticles that differ in size and composition can be designed to scatter light of different wavelengths according to their distinct surface plasmon resonances [Mie, G. *Ann. Phys.* 1908, 25, 377]. Scattered light from different sized nanoparticles has been used in histochemical imaging [Schultz, S.; Smith, D.R.; Mock, J.J.; Schultz, D.A. *Proc. Natl. Acad. Sci. USA* 2000, 97, 996; Yguerabide, J.;

Yguerabide, E.E. *Anal. Biochem.* **1998**, *262*, 157], but nanoparticle labels have not been used for multicolor labeling in array-based detection schemes. Particles of varying size and composition, which have been modified with a dense layer of oligonucleotides, can be used to yield DNA detection systems with multicolor capabilities and, in principle, the same selectivity advantages observed in the scanometric detection system. Herein we report that imaging the light scattered by oligonucleotide-functionalized, 50 and 100 nm diameter Au nanoparticle probes hybridized to targets captured by a DNA array can be used to identify two target sequences in one solution. In addition, we show that, as with the scanometric array method, the unique melting properties of nanoparticle probes lead to enhanced sequence selectivity when DNA arrays are imaged by scattered light from bound nanoparticles.

The DNA sequences of the array capture strands, the oligonucleotide-functionalized nanoparticle labels, and the targets to be detected were designed to cohybridize in a three-component sandwich assay (Figure 61). [Taton, T.A.; Mirkin, C.A.; Letsinger, R.L. *Science* **200**, *289*, 1757]. Test oligonucleotide targets were synthesized by automated solid phase synthesis, and oligonucleotide arrays were fabricated on glass microscope slides using literature procedures. [Taton, T.A.; Mirkin, C.A.; Letsinger, R.L. *Science* **200**, *289*, 1757; Chrisey, L.A.; Lee, G.U.; O'Ferrall, C.E. *Nucl. Acids Res.* **1996**, *24*, 3031.] 50 nm and 100 nm diameter gold nanoparticles were functionalized with dithiane-terminated oligonucleotides and isolated by literature methods. [Reynolds, R.A. III; Mirkin, C.A.; Letsinger, R.L. *J. Am. Chem. Soc.* **2000**, *122*, 3795; Letsinger, R.L.; Elghanian, R.; Viswanadham, G; Mirkin, C.A. *Bioconjugate Chem.* **2000**, *11*, 289], In a typical experiment, oligonucleotide-nanoparticle conjugates and oligonucleotide targets were cohybridized to the DNA arrays in 0.3 M PBS hybridization buffer [0.3 M NaCl, 10 mM NaH<sub>2</sub>PO<sub>4</sub>/Na<sub>2</sub>HPO<sub>4</sub>, pH 7] at room temperature for 2 h. [ See Examples 30 and 31 below]. The arrays were then washed with clean buffer to remove unhybridized target and nanoparticle probes. The array slides were mounted on a microscope stage and illuminated in the plane of the slide by a fiber optic illuminator [Darklite Illuminator (Micro Video Instruments, Avon, MA)]; in this configuration, the slide served as a

planar waveguide, preventing any light from reaching the microscope objective by total internal reflectance. Wherever nanoparticle probes were attached to the surface of the waveguide, however, evanescently coupled light [Müller, G.J. In *Multichannel Image Detectors*; Talmi, Y., Ed.; ACS Symposium Series 102; American Chemical Society: Washington, DC, 1979; pp 239-262] was scattered out of the guide plane and was imaged as bright, colored spots on a dark background. In these experiments, green light ( $\lambda_{\text{max}} = 542 \text{ nm}$ ) was observed wherever 50 nm Au particles were attached to the waveguide, and orange light ( $\lambda_{\text{max}} = 583 \text{ nm}$ ) was similarly observed for attached 100 nm particles. Although scattering of light from large ( $\geq 200 \text{ nm}$ ) selenium particles attached to planar waveguides has been used to image DNA arrays [Stimpston, D.I.; Hoijer, J.V.; Hsieh, W.; Jou, C.; Gordon, J.; Theriault, T.; Gamble, R.; Baldeschwieler, J.D. *Proc. Natl. Acad. Sci. USA* 1995, 92, 6379], two features of the system we describe herein distinguish it from previous work: i) the remarkable sequence selectivity caused by the sharp melting profiles inherent to densely functionalized, oligonucleotide-gold nanoparticle hybrids, and ii) the observation that different particle sizes, and in principle, different particle compositions, provide multicolor analysis of oligonucleotide arrays.

In order to test the potential of this system to do multiple-color analysis of two different DNA targets in one solution, a mixture of 10 nM 50 nm particles functionalized with DNA sequence *a*, 3.5 nM 100 nm Au particles functionalized with DNA sequence *b*, and 200 nM synthetic oligonucleotide targets *a'c'* and *b'd'* was exposed to a glass slide spotted with sequences *c* and *d* (Figure 61A) [Further details of array hybridization, imaging and sensitivity can be found in Examples 30 and 31]. In the presence of both targets *a'c'* and *b'd'* the two different nanoparticle probes were successfully and independently hybridized to the corresponding complementary slide spots, as demonstrated by the scattered green light imaged at the test spot for sequence *a'c'* and the scattered orange light at the test spot for sequence *c'd'* (Figure 62A). The low scattered light intensity measured away from the spots is a reflection of minimal nonspecific binding of the nanoparticles to the slide surface. In the presence of only target *a'c'* or *b'd'*, only the green light or the orange light is observed, respectively (Figure 62B,C). Little background signal is observed in either

case at the noncomplementary spot. Scattered light due to hybridized nanoparticle probes could be distinguished from background signal in the presence of as little as 1 pM of target [Further details of array hybridization, imaging and sensitivity can be found in Examples 30 and 31], indicating that the method is sensitive enough for the analysis of DNA from biological sources. Note that no scattered light was observed when the DNA functionalized microscope slide was treated with the two different nanoparticle probes in the absence of targets (Figure 62D).

To test the selectivity of this new scattering detection system based on nanoparticle probes, we synthesized model DNA arrays containing four elements, with each element bearing capture strands containing one of the four possible nucleotides at a particular sequence position. These arrays were incubated at room temperature with a solution which was 200 nM in a target complementary to one of the four elements ( $X = A$ , Figure 61B) and 10 nM in 50 nm diameter nanoparticle probes [Further details of array hybridization, imaging and sensitivity can be found in Examples 30 and 31]. The arrays were then washed to remove unhybridized target and probes and resubmerged in clean hybridization buffer. The dissociation of the hybridized nanoparticles from the array surface was then induced and continuously observed by gradually raising the temperature of the buffer. As long as this temperature did not exceed the melting temperature ( $T_m$ ) of either the complementary or the mismatched DNA duplexes, scattered light was observed at all four array elements (Figure 63A), indicating that no dissociation had taken place. However, as the temperature of the buffer was further increased, the nanoparticle probes dissociated from the slide in the order of the thermal stability of the varied base pair (T:T about equal to C:T < G:T < A:T, Figure 63A). Because the dissociation of nanoparticles from the slide was observed in real time, the optimal stringency temperature, selectivity, and target sequence could all readily be determined visually as the experiment progressed. In addition, quantitative melting profiles for all array elements were generated and compared simultaneously by measuring the signal intensity at each element in real time (Figure 63B). At the temperature of optimal stringency (55°C, shown by the vertical line in Figure 63B), the signal at the complementary ( $X = A$ ) element is five times higher than that of the element

containing a G:T "wobble" mismatch. This represents significantly higher sequence selectivity than previously observed for molecular fluorophore probes and arrays with identical sequences [Taton, T.A.; Mirkin, C.A.; Letsinger, R.L. *Science* **200**, 289, 1757]. As was observed for small (13 nm diameter) nanoparticles via the black and white scanometric approach [Taton, T.A.; Mirkin, C.A.; Letsinger, R.L. *Science* **200**, 289, 1757], the higher selectivity of the 50 nm particle probes compared to fluorophore-labeled DNA is a direct consequence of the narrow temperature range over which the nanoparticles dissociate from the array surface; the full width at half maximum for the first derivative of the curves shown in Figure 63B is 5°C, compared to 18°C for fluorophore-labeled DNA with identical sequences [Taton, T.A.; Mirkin, C.A.; Letsinger, R.L. *Science* **200**, 289, 1757]. The results presented here demonstrate that this selectivity also can be used in conjunction with multicolor labeling of multiple DNA targets on the same chip.

The DNA array imaging method described herein, based on scattered light from larger oligonucleotide-functionalized nanoparticles, provides the opportunity for sensitive, ultrasensitive, multicolor labeling of DNA arrays. In theory, the method described will be extendable to additional colors using nanoparticles of different compositions and sizes [Link, S.; Wang, Z.L.; El-Sayed, M.A. *J. Phys. Chem. B* **1999**, *103*, 3529]. In addition, the use of particles with higher scattering coefficients may permit this system to rival the high sensitivity of the scanometric nanoparticle system<sup>5</sup> and waveguide-based fluorescence arrays [Budach, W.; Abel, A.P.; Bruno, A.E.; Neuschäfer, D. *Anal. Chem.* **1999**, *71*, 3347]. U.S. Patent No. 5,599,668, the disclosure which is incorporated by reference herein in its entirety, describes a light scattering optical waveguide method for detecting binding events, however, this patent does not disclose or suggest the use of the nanoparticles conjugates of the present invention.

The inventive method involves detecting the scattering of light directed into the waveguide, the scattering being the result of light scattering nanoparticle conjugates of the invention specifically bound to the waveguide within the penetration depth of an evanescent wave. The waveguide may be transparent plastic or glass or any suitable material and the binding is typically by oligonucleotide hybridization or



if desired, by immunological capture as described above. Light scattering detectable nanoparticle probes may be prepared from any of the novel metal or semiconductor nanoparticles, including gold, prepared by the inventive ageing process described above. Real-time binding and dissociation can be monitored visually or by video  
5 imaging, such as with a CCD camera and frame grabber software. Hybridization mismatches of as few as one base can be distinguished by real-time melting curves.

In practicing the invention, the waveguide should be made of an optically transparent material such as glass, quartz, plastics such as polycarbonate, acrylic, or polystyrene. The refractive index of the waveguide must be greater than the refractive  
10 index of the sample fluid, as is known in the art for effecting total internal reflectance. For an aqueous sample solution, the refractive index,  $n$ , is about 1.33, so the waveguide typically has a refractive index of greater than 1.35, usually about 1.5 or more. The waveguide includes a light receiving end such as the one shown in Figures 64 and 65B. The waveguide may be a piece of plastic or glass, for example, a  
15 standard glass microscope slide or cover slip may be used. The surface of the waveguide may be treated by any suitable method described above to attach oligonucleotides thereto to supports, preferably in a covalent manner.

Light source for generating the incident light beam may be nearly any source of electromagnetic energy, including energy in the visible, ultraviolet, and near-IR  
20 spectra. The term "light" is thus construed quite broadly and is not confined to the visible range, except in the embodiments that are visually detected. Non-visible wavelengths are detected by detectors optimized for the particular wavelength as is well known in the art. The light may be monochromatic or polychromatic, collimated or uncollimated, polarized or unpolarized. Preferred light sources include lasers, light  
25 emitting diodes, flash lamps, arc lamps, incandescent lamps and fluorescent discharge lamps. The light source used to illuminate the waveguide element can be a low wattage helium-neon laser. For a portable disposable such as that described in example 1 below, the light source can be a small incandescent light bulb powered by a battery, such as is used in pocket flashlight. Preferably, the light source includes  
30 potentiometer means for varying the intensity of the light source. Alternatively, filters and/or lenses may be employed to adjust the intensity to a suitable level.

Detection means for determining the degree of light scattering are described in detail below but briefly comprise both instrument and visual means. It is an important feature of the invention that light scattering events across the entire waveguide can be monitored essentially simultaneously, whether by the eye and brain  
5 of an observer or by photodetection devices including CCD cameras forming images that are digitized and processed using computers. In each case only a single, multi-functional surface is used and is illuminated simultaneously by the evanescent wave.

The invention also relates to a salt-based stringency wash for enhancing target selectivity in a detection method. Increasing target nucleic acid analyte  
10 selectivity generally involves a adjustment of the hybridization conditions or the use of a thermal based stringency wash at melting temperatures in a post-hybridization step that results in dehybridization of nucleic acid duplexes from base mismatched or non-complementary strands. Generally, the greater the stringency of the subsequent wash step, the fewer, if any, mismatches remain in the duplex structure. The  
15 nanoparticle-oligonucleotide conjugates of the invention have been found to exhibit a remarkable salt concentration dependent hybridization behavior that can be exploited to achieve superior target selectivity in a detection system without the need for a post-hybridization thermal stringency wash. For instance, Example 32 demonstrates that the oligonucleotide-modified nanoparticles of the invention exhibit unusually sharp  
20 denaturation properties over salt concentration gradients. Such a salt-based stringency wash detection system would be useful in a hand-held DNA detection system, would be amenable to massive multiplexing, and would exhibit higher selectivity relative to fluorophore based systems. The use of salt concentration as a stringency tool rather than temperature is provides a number of surprising and unexpected advantages,  
25 including eliminating the need for thermocyclers in nanoparticle-based detection systems and providing higher selectivity than temperature-based stringency for nanoparticle probes. In addition, the use of salt concentration as a stringency tool is useful where the detection probe are not stable at elevated temperature.

Accordingly, in one embodiment of the invention, a method for detecting a  
30 nucleic acid is provided. The method comprises providing a substrate having oligonucleotides bound thereto, the oligonucleotides bound to the substrate have a

sequence that is complementary to a first portion of a sequence of a nucleic acid; providing labels, such as nanoparticles, having oligonucleotides bound thereto, at least some of the oligonucleotides having a sequence that is complementary to the sequence of a second portion of the nucleic acid; contacting the substrate, nucleic acid, and labels, the contacting taking place under conditions effective to allow hybridization between the oligonucleotides bound to the substrate with the nucleic acids and between the nucleic acid and the oligonucleotide bound to the label so as to form a test substrate having labels complexed thereto; contacting the test substrate with an aqueous salt solution having a salt concentration effective to substantially remove non-specifically bound labels; and observing a detectable change. Upon contacting the immobilized capture probe, target nucleic acid, and nanoparticle conjugate under hybridization conditions for a predetermined time period, stringency may be adjusted in a post-hybridization wash step that employs an aqueous salt solution of a proper cationic strength.

Any suitable stringency wash solution may be employed in practicing this invention including wash solutions described in Maniatis's *Molecular Cloning: A Laboratory Manual*, Second edition (Cold Spring Harbor Laboratory Press), 1989 and Ausubel et al., *Short Protocols in Molecular Biology*, fourth Edition (John Wiley & Sons), 1999. Representative aqueous salt solution comprise a salt selected from the group consisting of sodium chloride, magnesium chloride, potassium chloride, ammonium chloride, sodium acetate, ammonium acetate, a combination of two or more of these salts, one of these salts in a phosphate buffer, and a combination of two or more of these salts in a phosphate buffer. While phosphate buffer is preferred, any other buffer or combination of two or more suitable buffers may be used. Representative examples of suitable buffers include, without limitation, tris (hydroxymethyl)aminomethane (TRIS) and TRIS-HCl buffer.

Any suitable concentration of the salt and buffer components in the stringency wash solution may be used. The skilled artisan will know how to adjust the salt solution to achieve a proper cationic concentration. For instance, the skilled artisan may evaluate a range of solutions of different cationic concentration and further prepare a dissociation curve, similar to the one shown in Figure 69(C) (Example 32).

A representative stringency solution is described in Example 32 and includes sodium chloride in a phosphate buffer. The sodium chloride salt component generally ranges from about 0 M to about 0.5 M, preferably from about 0.005 M to about 0.1 M. The phosphate buffer component generally ranges from about 0.01 mM to about 15 mM, preferably about 10 mM. The stringency buffer may have any suitable pH, generally about pH 7. In using the salt based wash as a post-hybridization wash, stringency levels of at least 90% or greater, preferably at least 95% or 97%, may be achieved.

While the nanoparticles of the invention are the preferred labels, the salt-based stringency wash system can be expanded to any other suitably charged labels having oligonucleotides. Representative labels include, without limitation, radioisotopes, fluorescent dyes such as fluorescein or tetramethylrhodamine, enzymes such as alkaline or horseradish peroxidase, reporter groups such as biotin or digoxigenin, polyanionic polymers, and spectroscopic labels such as raman dyes.

The salt concentration dependent post-hybridization stringency conditions rely, in part, on the adjustment of the cationic strength of the solution. A skilled artisan will recognize how to adjust other factors such as pH and temperature as necessary to accommodate factors such as oligonucleotide probe length, label used, and the like.

In another embodiment of the invention, the salt-based stringency wash may be used to detect target nucleic acid(s) having at least two portions in a method comprising the steps of (a) contacting a nucleic acid with a substrate having oligonucleotides attached thereto, the oligonucleotides being located between a pair of electrodes, the oligonucleotides having a sequence complementary to a first portion of the sequence of said nucleic acid, the contacting taking place under conditions effective to allow hybridization of the oligonucleotides on the substrate with said nucleic acid; (b) contacting said nucleic acid bound to the substrate with a first type of labels such as nanoparticles, the labels being made of a material which can conduct electricity, the labels having one or more types of oligonucleotides attached thereto, at least one of the types of oligonucleotides having a sequence complementary to a second portion of the sequence of said nucleic acid, the contacting taking place under

conditions effective to allow hybridization of the oligonucleotides on the labels with said nucleic acid so as to form a test substrate having labels complexed thereto; (c) contacting the test substrate with an aqueous salt solution having a salt concentration effective to sufficiently remove non-specifically bound labels; and (d) detecting a  
5 change in an electrical property of the electrodes.

As described herein, the substrate may include a plurality of pairs of electrodes located on it in an array to allow for the detection of multiple portions of a single nucleic acid, the detection of multiple different nucleic acids, or both, each of the pairs of electrodes having a type of oligonucleotides attached to the substrate  
10 between them. When the nanoparticles conjugate probes of the invention are used and target nucleic acid is present, the circuit between the electrodes should be closed or can be made to close by any suitable material as discussed herein including the use of silver, gold, or any other conductive materials such as metals or material that can catalyze the local aggrandization of material that can conduct electricity including  
15 elemental carbon. The presence of the closed circuit can be detected by any suitable means such as a change in the electrical property of the electrodes. Such a change can be detected by any suitable means including, without limitation, a change in conductivity, resistivity, capacitance, or impedance.

It is to be noted that the term "a" or "an" entity refers to one or more of that  
20 entity. For example, "a characteristic" refers to one or more characteristics or at least one characteristic. As such, the terms "a" (or "an"), "one or more" and "at least one" are used interchangeably herein. It is also to be noted that the terms "comprising", "including", and "having" have been used interchangeably.

## EXAMPLES

### Example 1: Preparation of Oligonucleotide-Modified Gold Nanoparticles

#### A. Preparation Of Gold Nanoparticles

5 Gold colloids (13 nm diameter) were prepared by reduction of H<sub>2</sub>AuCl<sub>4</sub> with citrate as described in Frens, *Nature Phys. Sci.*, 241, 20 (1973) and Grabar, *Anal. Chem.*, 67, 735 (1995). Briefly, all glassware was cleaned in aqua regia (3 parts HCl, 1 part HNO<sub>3</sub>), rinsed with Nanopure H<sub>2</sub>O, then oven dried prior to use. H<sub>2</sub>AuCl<sub>4</sub> and sodium citrate were purchased from Aldrich Chemical Company. Aqueous H<sub>2</sub>AuCl<sub>4</sub> (1 mM, 500  
10 mL) was brought to reflux while stirring. Then, 38.8 mM sodium citrate (50 mL) was added quickly. The solution color changed from pale yellow to burgundy, and refluxing was continued for 15 min. After cooling to room temperature, the red solution was filtered through a Micron Separations Inc. 1 micron filter. Au colloids were characterized by UV-vis spectroscopy using a Hewlett Packard 8452A diode array  
15 spectrophotometer and by Transmission Electron Microscopy (TEM) using a Hitachi 8100 transmission electron microscope. Gold particles with diameters of 13 nm will produce a visible color change when aggregated with target and probe oligonucleotide sequences in the 10-35 nucleotide range.

#### B. Synthesis Of Oligonucleotides

20 Oligonucleotides were synthesized on a 1 micromole scale using a Milligene Expedite DNA synthesizer in single column mode using phosphoramidite chemistry. Eckstein, F. (ed.) *Oligonucleotides and Analogues: A Practical Approach* (IRL Press, Oxford, 1991). All solutions were purchased from Milligene (DNA synthesis grade). Average coupling efficiency varied from 98 to 99.8%, and the final dimethoxytrityl  
25 (DMT) protecting group was not cleaved from the oligonucleotides to aid in purification.

For 3'-thiol-oligonucleotides, Thiol-Modifier C3 S-S CPG support was purchased from Glen Research and used in the automated synthesizer. During normal cleavage from the solid support (16 hr at 55° C), 0.05 M dithiothreitol (DTT) was added to the

NH<sub>4</sub>OH solution to reduce the 3' disulfide to the thiol. Before purification by reverse phase high pressure liquid chromatography (HPLC), excess DTT was removed by extraction with ethyl acetate.

For 5'-thiol oligonucleotides, 5'-Thiol-Modifier C<sub>6</sub>-phosphoramidite reagent was purchased from Glen Research, 44901 Falcon Place, Sterling, Va 20166. The oligonucleotides were synthesized, and the final DMT protecting group removed. Then, 1 ml of dry acetonitrile was added to 100 μmole of the 5' Thiol Modifier C<sub>6</sub>-phosphoramidite. 200 μL of the amidite solution and 200 μL of activator (fresh from synthesizer) were mixed and introduced onto the column containing the synthesized oligonucleotides still on the solid support by syringe and pumped back and forth through the column for 10 minutes. The support was then washed (2 x 1 mL) with dry acetonitrile for 30 seconds. 700 μL of a 0.016 M I<sub>2</sub>/H<sub>2</sub>O/pyridine mixture (oxidizer solution) was introduced into the column, and was then pumped back and forth through the column with two syringes for 30 second. The support was then washed with a 1:1 mixture of CH<sub>3</sub>CN/pyridine (2 x 1 mL) for 1 minute, followed by a final wash with dry acetonitrile (2 x 1 mL) with subsequent drying of the column with a stream of nitrogen. The trityl protecting group was not removed, which aids in purification.

Reverse phase HPLC was performed with a Dionex DX500 system equipped with a Hewlett Packard ODS hypersil column (4.6 x 200 mm, 5 mm particle size) using 0.03 M Et<sub>3</sub>NH<sup>+</sup> OAc<sup>-</sup> buffer (TEAA), pH 7, with a 1%/min. gradient of 95% CH<sub>3</sub>CN/5% TEAA. The flow rate was 1 mL/min. with UV detection at 260 nm. Preparative HPLC was used to purify the DMT-protected unmodified oligonucleotides (elution at 27 min). After collection and evaporation of the buffer, the DMT was cleaved from the oligonucleotides by treatment with 80% acetic acid for 30 min at room temperature. The solution was then evaporated to near dryness, water was added, and the cleaved DMT was extracted from the aqueous oligonucleotide solution using ethyl acetate. The amount of oligonucleotide was determined by absorbance at 260 nm, and final purity assessed by reverse phase HPLC (elution time 14.5 minutes).

The same protocol was used for purification of the 3'-thiol-oligonucleotides, except that DTT was added after extraction of DMT to reduce the amount of disulfide formed. After six hours at 40°C, the DTT was extracted using ethyl acetate, and the oligonucleotides repurified by HPLC (elution time 15 minutes).

5 For purification of the 5' thiol modified oligonucleotides, preparatory HPLC was performed under the same conditions as for unmodified oligonucleotides. After purification, the trityl protecting group was removed by adding 150  $\mu$ L of a 50 mM  $\text{AgNO}_3$  solution to the dry oligonucleotide sample. The sample turned a milky white color as the cleavage occurred. After 20 minutes, 200  $\mu$ L of a 10 mg/ml solution of DTT  
10 was added to complex the Ag (five minute reaction time), and the sample was centrifuged to precipitate the yellow complex. The oligonucleotide solution (<50 OD) was then transferred onto a desalting NAP-5 column (Pharmacia Biotech, Uppsala, Sweden) for purification (contains DNA Grade Sephadex G-25 Medium for desalting and buffer exchange of oligonucleotides greater than 10 bases). The amount of 5' thiol modified  
15 oligonucleotide was determined by UV-vis spectroscopy by measuring the magnitude of the absorbance at 260 nm. The final purity was assessed by performing ion-exchange HPLC with a Dionex Nucleopac PA-100 (4 x 250) column using a 10 mM NaOH solution (pH 12) with a 2%/min gradient of 10 mM NaOH, 1M NaCl solution. Typically, two peaks resulted with elution times of approximately 19 minutes and 25 minutes  
20 (elution times are dependent on the length of the oligonucleotide strand). These peaks corresponded to the thiol and the disulfide oligonucleotides respectively.

#### C. Attachment Of Oligonucleotides To Gold Nanoparticles

An aqueous solution of 17nM (150  $\mu$ L) Au colloids, prepared as described in part A above, was mixed with 3.75  $\mu$ M (46  $\mu$ L) 3'-thiol-TTTGCTGA, prepared as described  
25 in part B and allowed to stand for 24 hours at room temperature in 1 ml Eppendorf capped vials. A second solution of colloids was reacted with 3.75  $\mu$ M (46  $\mu$ L) 3'-thiol-TACCGTTG. Note that these oligonucleotides are noncomplementary. Shortly before use, equal amounts of each of the two nanoparticle solutions were combined. Since the



oligonucleotides are noncomplementary, no reaction took place.

The oligonucleotide-modified nanoparticles are stable at elevated temperatures (80°C) and high salt concentrations (1M NaCl) for days and have not been observed to undergo particle growth. Stability in high salt concentrations is important, since such  
5 conditions are required for the hybridization reactions that form the basis of the methods of detection and nanofabrication of the invention.

Example 2: Formation Of Nanoparticle Aggregates

A. Preparation Of Linking Oligonucleotide

10 Two (nonthiolated) oligonucleotides were synthesized as described in part B of Example 1. They had the following sequences:

3' ATATGCGCGA TCTCAGCAA [SEQ ID NO:1]; and

3' GATCGCGCAT ATCAACGGTA [SEQ ID NO:2].

Mixing of these two oligonucleotides in a 1 M NaCl, 10 mM phosphate buffered  
15 (pH 7.0) solution, resulted in hybridization to form a duplex having a 12-base-pair overlap and two 8-base-pair sticky ends. Each of the sticky ends had a sequence which was complementary to that of one of the oligonucleotides attached to the Au colloids prepared in part C of Example 1.

B. Formation Of Nanoparticle Aggregates

20 The linking oligonucleotides prepared in part A of this example (0.17 μM final concentration after dilution with NaCl) were added to the nanoparticle-oligonucleotide conjugates prepared in part C of Example 1 (5.1 nM final concentration after dilution with NaCl) at room temperature. The solution was then diluted with aqueous NaCl (to a final concentration of 1 M) and buffered at pH 7 with 10 mM phosphate, conditions  
25 which are suitable for hybridization of the oligonucleotides. An immediate color change from red to purple was observed, and a precipitation reaction ensued. See Figure 6. Over the course of several hours, the solution became clear and a pinkish-gray precipitate settled to the bottom of the reaction vessel. See Figure 6.

To verify that this process involved both the oligonucleotides and colloids, the precipitate was collected and resuspended (by shaking) in 1 M aqueous NaCl buffered at pH 7. Any of the oligonucleotides not hybridized to the nanoparticles are removed in this manner. Then, a temperature/time dissociation experiment was performed by monitoring  
5 the characteristic absorbance for the hybridized oligodeoxyribonucleotides (260 nm) and for the aggregated colloids which is reflective of the gold interparticle distance (700 nm). See Figure 7.

Changes in absorbance at 260 and 700 nm were recorded on a Perkin-Elmer Lambda 2 UV-vis Spectrophotometer using a Peltier PTP-1 Temperature Controlled Cell  
10 Holder while cycling the temperature at a rate of 1°C/minute between 0°C and 80°C. DNA solutions were approximately 1 absorbance unit(s) (OD), buffered at pH 7 using 10 mM phosphate buffer and at 1M NaCl concentration.

The results are shown in Figure 8A. As the temperature was cycled between 0°C and 80°C (which is 38°C above the dissociation temperature ( $T_m$ ) for the duplex ( $T_m=42$   
15 °C)), there was an excellent correlation between the optical signatures for both the colloids and oligonucleotides. The UV-vis spectrum for naked Au colloids was much less temperature dependent, Figure 8B.

There was a substantial visible optical change when the polymeric oligonucleotide-colloid precipitate was heated above its melting point. The clear solution  
20 turned dark red as the polymeric biomaterial de-hybridized to generate the unlinked colloids which are soluble in the aqueous solution. The process was reversible, as evidenced by the temperature traces in Figure 8A.

In a control experiment, a 14-T:14-A duplex was shown to be ineffective at inducing reversible Au colloid particle aggregation. In another control experiment, a  
25 linking oligonucleotide duplex with four base pair mismatches in the sticky ends was found not to induce reversible particle aggregation of oligonucleotide-modified nanoparticles (prepared as described in part C of Example 1 and reacted as described above). In a third control experiment, non-thiolated oligonucleotides having sequences

complementary to the sticky ends of the linking oligonucleotide and reacted with nanoparticles did not produce reversible aggregation when the nanoparticles were combined with the linking oligonucleotide.

Further evidence of the polymerization/assembly process came from  
5 Transmission Electron Microscopy (TEM) studies of the precipitate. TEM was performed on a Hitachi 8100 Transmission Electron Microscope. A typical sample was prepared by dropping 100  $\mu$ L of colloid solution onto a holey carbon grid. The grid, then, was dried under vacuum and imaged. TEM images of Au colloids linked by hybridized oligonucleotides showed large assembled networks of the Au colloids, Figure  
10 9A. Naked Au colloids do not aggregate under comparable conditions but rather disperse or undergo particle growth reactions. Hayat, *Colloidal Gold: Principles, Methods, and Applications* (Academic Press, San Diego, 1991). Note that there is no evidence of colloid particle growth in the experiments performed to date; the hybridized colloids seem to be remarkably regular in size with an average diameter of 13 nm.

15 With TEM, a superposition of layers is obtained, making it difficult to assess the degree of order for three-dimensional aggregates. However, smaller scale images of single layer, two-dimensional aggregates provided more evidence for the self-assembly process, Figure 9B. Close-packed assemblies of the aggregates with uniform particle separations of approximately 60  $\text{\AA}$  can be seen. This distance is somewhat shorter than  
20 the estimated 95  $\text{\AA}$  spacing expected for colloids connected by rigid oligonucleotide hybrids with the sequences that were used. However, because of the nicks in the duplex obtained after hybridization of the oligonucleotides on the nanoparticles to the linking oligonucleotides, these were not rigid hybrids and were quite flexible. It should be noted that this is a variable that can be controlled by reducing the system from four overlapping  
25 strands to three (thereby reducing the number of nicks) or by using triplexes instead of duplexes.

Example 3: Preparation of Oligonucleotide-Modified Gold Nanoparticles

Gold colloids (13 nm diameter) were prepared as described in Example 1. Thiol-oligonucleotides [HS(CH<sub>2</sub>)<sub>6</sub>OP(O)(O)-oligonucleotide] were also prepared as described in Example 1.

The method of attaching thiol-oligonucleotides to gold nanoparticles described in Example 1 was found not to produce satisfactory results in some cases. In particular, when long oligonucleotides were used, the oligonucleotide-colloid conjugates were not stable in the presence of a large excess of high molecular weight salmon sperm DNA used as model for the background DNA that would normally be present in a diagnostic system. Longer exposure of the colloids to the thiol-oligonucleotides produced oligonucleotide-colloid conjugates that were stable to salmon sperm DNA, but the resulting conjugates failed to hybridize satisfactorily. Further experimentation led to the following procedure for attaching thiol-oligonucleotides of any length to gold colloids so that the conjugates are stable to high molecular weight DNA and hybridize satisfactorily.

A 1 mL solution of the gold colloids (17nM) in water was mixed with excess (3.68 :M) thiol-oligonucleotide (28 bases in length) in water, and the mixture was allowed to stand for 12-24 hours at room temperature. Then, 100 μL of a 0.1 M sodium hydrogen phosphate buffer, pH 7.0, and 100 μL of 1.0 M NaCl were premixed and added. After 10 minutes, 10 μL of 1% aqueous NaN<sub>3</sub> were added, and the mixture was allowed to stand for an additional 40 hours. This "aging" step was designed to increase the surface coverage by the thiol-oligonucleotides and to displace oligonucleotide bases from the gold surface. Somewhat cleaner, better defined red spots in subsequent assays were obtained if the solution was frozen in a dry-ice bath after the 40-hour incubation and then thawed at room temperature. Either way, the solution was next centrifuged at 14,000 rpm in an Eppendorf Centrifuge 5414 for about 15 minutes to give a very pale pink supernatant containing most of the oligonucleotide (as indicated by the absorbance at 260 nm) along with 7-10% of the colloidal gold (as indicated by the absorbance at 520 nm), and a compact, dark, gelatinous residue at the bottom of the tube. The supernatant was removed, and the residue was resuspended in about 200 μL of buffer (10 mM

phosphate, 0.1 M NaCl) and recentrifuged. After removal of the supernatant solution, the residue was taken up in 1.0 mL of buffer (10 mM phosphate, 0.1 M NaCl) and 10  $\mu$ L of a 1% aqueous solution of  $\text{NaN}_3$ . Dissolution was assisted by drawing the solution into, and expelling it from, a pipette several times. The resulting red master solution was stable  
5 (i.e., remained red and did not aggregate) on standing for months at room temperature, on spotting on silica thin-layer chromatography (TLC) plates (see Example 4), and on addition to 2 M NaCl, 10 mM  $\text{MgCl}_2$ , or solutions containing high concentrations of salmon sperm DNA.

10 Example 4: Acceleration Of Hybridization of Nanoparticle-Oligonucleotide Conjugates

The oligonucleotide-gold colloid conjugates I and II illustrated in Figure 11 were prepared as described in Example 3. The hybridization of these two conjugates was extremely slow. In particular, mixing samples of conjugates I and II in aqueous 0.1 M NaCl or in 10 mM  $\text{MgCl}_2$  plus 0.1 M NaCl and allowing the mixture to stand at room  
15 temperature for a day produced little or no color change.

Two ways were found to improve hybridization. First, faster results were obtained by freezing the mixture of conjugates I and II (each 15 nM contained in a solution of 0.1 M NaCl) in a dry ice-isopropyl alcohol bath for 5 minutes and then  
20 thawing the mixture at room temperature. The thawed solution exhibited a bluish color. When 1  $\mu$ L of the solution was spotted on a standard C-18 TLC silica plate (Alltech Associates), a strong blue color was seen immediately. The hybridization and consequent color change caused by the freeze-thawing procedure were reversible. On heating the hybridized solution to 80°C, the solution turned red and produced a pink spot on a TLC  
25 plate. Subsequent freezing and thawing returned the system to the (blue) hybridized state (both solution and spot on a C-18 TLC plate). In a similar experiment in which the solution was not refrozen, the spot obtained on the C-18 TLC plate was pink.

A second way to obtain faster results is to warm the conjugates and target. For

instance, in another experiment, oligonucleotide-gold colloid conjugates and an oligonucleotide target sequence in a 0.1 M NaCl solution were warmed rapidly to 65°C and allowed to cool to room temperature over a period of 20 minutes. On spotting on a C-18 silica plate and drying, a blue spot indicative of hybridization was obtained. In contrast, incubation of the conjugates and target at room temperature for an hour in 0.1 M NaCl solution did not produce a blue color indicative of hybridization. Hybridization is more rapid in 0.3 M NaCl.

Example 5: Assays Using Nanoparticle-Oligonucleotide Conjugates

The oligonucleotide-gold colloid conjugates 1 and 2 illustrated in Figures 12A-F were prepared as described in Example 3, and the oligonucleotide target 3 illustrated in Figure 12A was prepared as described in Example 2. Mismatched and deletion targets 4, 5, 6, and 7 were purchased from the Northwestern University Biotechnology Facility, Chicago, IL. These oligonucleotides were synthesized on a 40 nmol scale and purified on an reverse phase C18 cartridge (OPC). Their purity was determined by performing ion exchange HPLC.

Selective hybridization was achieved by heating rapidly and then cooling rapidly to the stringent temperature. For example, hybridization was carried out in 100  $\mu$ L of 0.1 M NaCl plus 5 mM  $MgCl_2$  containing 15 nM of each oligonucleotide-colloid conjugate 1 and 2, and 3 nanomoles of target oligonucleotide 3, 4, 5, 6, or 7, heating to 74°C, cooling to the temperatures indicated in Table 1 below, and incubating the mixture at this temperature for 10 minutes. A 3  $\mu$ L sample of each reaction mixture was then spotted on a C-18 TLC silica plate. On drying (5 minutes), a strong blue color appeared if hybridization had taken place.

The results are presented in Table 1 below. Pink spots signify a negative test (*i.e.*, that the nanoparticles were not brought together by hybridization), and blue spots signify a positive test (*i.e.*, that the nanoparticles were brought into proximity due to hybridization involving both of the oligonucleotide-colloid conjugates).

TABLE 1

Reactants	Results (Color)			
	45°C	50°C	60°C	74°C
1 + 2	Pink	Pink	Pink	Pink
1 + 2 + 3 (match)	Blue	Blue	Blue	Blue
1 + 2 + 4 (half complement mismatch)	Pink	Pink	Pink	Pink
1 + 2 + 5 (-6 bp)	Blue	Pink	Pink	Pink
1 + 2 + 6 (1 bp mismatch)	Blue	Blue	Pink	Pink
1 + 2 + 7 (2 bp mismatch)	Pink	Pink	Pink	Pink

5 As can be seen in Table 1, hybridization at 60°C gave a blue spot only for the fully-matched target 3. Hybridization at 50°C yielded blue spots with both targets 3 and 6. Hybridization at 45°C gave blue spots with targets 3, 5 and 6.

10 In a related series, a target containing a single mismatch T nucleotide was found to give a positive test at 58°C (blue color) and a negative test (red color) at 64°C with conjugates 1 and 2. Under the same conditions, the fully-matched target (3) gave a positive test at both temperatures, showing that the test can discriminate between a target that is fully matched and one containing a single mismatched base.

15 Similar results were achieved using a different hybridization method. In particular, selective hybridization was achieved by freezing, thawing and then warming rapidly to the stringent temperature. For example, hybridization was carried out in 100 µL of 0.1 M NaCl containing 15 nM of each oligonucleotide-colloid conjugate 1 and 2, and 10 picomoles of target oligonucleotide 3, 4, 5, 6, or 7, freezing in a dry ice-isopropyl alcohol bath for 5 minutes, thawing at room temperature, then warming rapidly to the  
20 temperatures indicated in Table 2 below, and incubating the mixture at this temperature for 10 minutes. A 3 µL sample of each reaction mixture was then spotted on a C-18 TLC silica plate. The results are presented in Table 2.

TABLE 2

Reactants (probes) + target	Results (color)				
	RT	35°C	40°C	54°C	64°C
(1 + 2) + 3	blue	blue	blue	blue	pink
(1 + 2)	pink	pink	pink	pink	pink
(1 + 2) + 4	pink	pink	pink	pink	pink
(1 + 2) + 5	blue	blue	pink	pink	pink
(1 + 2) + 6	blue	blue	blue	pink	pink
(1 + 2) + 7	blue	pink	pink	pink	pink

- 5 An important feature of these systems was that the color change associated with the temperature change was very sharp, occurring over a temperature range of about 1°C. This indicates high cooperativity in the melting and association processes involving the colloid conjugates and enables one to easily discriminate between oligonucleotide targets containing a fully-matched sequence and a single basepair mismatch.
- 10 The high degree of discrimination may be attributed to two features. The first is the alignment of two relatively short probe oligonucleotide segments (15 nucleotides) on the target is required for a positive signal. A mismatch in either segment is more destabilizing than a mismatch in a longer probe (*e.g.*, an oligonucleotide 30 bases long) in a comparable two-component detection system. Second, the signal at 260 nm, obtained
- 15 on hybridization of the target oligonucleotides with the nanoparticle conjugates in solution, is nanoparticle-based, not DNA-based. It depends on dissociation of an assembly of nanoparticles organized in a polymeric network by multiple oligonucleotide duplexes. This results in a narrowing of the temperature range that is observed for aggregate dissociation, as compared with standard DNA thermal denaturation. In short,
- 20 some duplexes in the crosslinked aggregates can dissociate without dispersing the nanoparticles into solution. Therefore, the temperature range for aggregate melting is very narrow (4°C) as compared with the temperature range associated with melting the comparable system without nanoparticles (12°C). Even more striking and advantageous



for this detection approach is the temperature range for the colorimetric response (<1°C) observe on the C18 silica plates. In principle, this three-component nanoparticle based strategy will be more selective than any two-component detection system based on a single-strand probe hybridizing with target nucleic acid.

5           A master solution containing 1 nmol of target 3 was prepared in 100 µl of hybridization buffer (0.3 M NaCl, 10 mM phosphate, pH 7). One µl of this solution corresponds to 10 picomole of target oligonucleotide. Serial dilutions were performed by taking an aliquot of the master solution and diluting it to the desired concentration with hybridization buffer. Table 3 shows the sensitivity obtained using 3 µl of a mixture of  
10 probes 1 and 2 with different amounts of target 3. After performing the hybridization using freeze-thaw conditions, 3 µl aliquots of these solutions were spotted onto C-18 TLC plates to determine color. In Table 3 below, pink signifies a negative test, and blue signifies a positive test.

15

TABLE 3

Amount of Target	Results
1 picomole	blue (positive)
200 femtomole	blue (positive)
100 femtomole	blue (positive)
20 femtomole	blue (positive)
10 femtomole	purplish (ambiguous)

This experiment indicates that 10 femtomoles is the lower limit of detection for this particular system.

20

Example 6: Assays Using Nanoparticle-Oligonucleotide Conjugates

DNA modified nanoparticles were adsorbed onto modified transparent substrates as shown in Figure 13B. This method involved the linking of DNA modified nanoparticles to nanoparticles that were attached to a glass substrate, using DNA  
25 hybridization interactions.

Glass microscope slides were purchased from Fisher scientific. Slides were cut into approximately 5 x 15 mm pieces, using a diamond tipped scribing pen. Slides were cleaned by soaking for 20 minutes in a solution of 4:1 H<sub>2</sub>SO<sub>4</sub>:H<sub>2</sub>O<sub>2</sub> at 50°C. Slides were then rinsed with copious amounts of water, then ethanol, and dried under a stream of dry nitrogen. To functionalize the slide surface with a thiol terminated silane, the slides were soaked in a degassed ethanolic 1% (by volume) mercaptopropyl-trimethoxysilane solution for 12 hours. The slides were removed from the ethanol solutions and rinsed with ethanol, then water. Nanoparticles were adsorbed onto the thiol terminated surface of the slides by soaking in solutions containing the 13 nm diameter gold nanoparticles (preparation described in Example 1). After 12 hours in the colloidal solutions, the slides were removed and rinsed with water. The resulting slides have a pink appearance due to the adsorbed nanoparticles and exhibit similar UV-vis absorbance profiles (surface plasmon absorbance peak at 520 nm) as the aqueous gold nanoparticle colloidal solutions. See Figure 14A.

DNA was attached to the nanoparticle modified surface by soaking the glass slides in 0.2 OD (1.7 μM) solution containing freshly purified 3' thiol oligonucleotide (3' thiol ATGCTCAACTCT [SEQ ID NO:33]) (synthesized as described in Examples 1 and 3). After 12 hours of soaking time, the slides were removed and rinsed with water.

To demonstrate the ability of an analyte DNA strand to bind nanoparticles to the modified substrate, a linking oligonucleotide was prepared. The linking oligonucleotide (prepared as described in Example 2) was 24 bp long (5' TACGAGTTGAGAATCCTGAATGCG [SEQ ID NO:34]) with a sequence containing a 12 bp end that was complementary to the DNA already adsorbed onto the substrate surface (SEQ ID NO:33). The substrate was then soaked in a hybridization buffer (0.5 M NaCl, 10 mM phosphate buffer pH 7) solution containing the linking oligonucleotide (0.4 OD, 1.7 μM) for 12 hours. After removal and rinsing with similar buffer, the substrate was soaked in a solution containing 13 nm diameter gold nanoparticles which had been modified with an oligonucleotide (TAGGACTTACGC 5' thiol [SEQ ID NO:35])

(prepared as described in Example 3) that is complementary to the unhybridized portion of the linking oligonucleotide attached to the substrate. After 12 hours of soaking, the substrate was removed and rinsed with the hybridization buffer. The substrate color had darkened to a purple color and the UV-vis absorbance at 520 nm approximately doubled (Figure 14A).

To verify that the oligonucleotide modified gold nanoparticles were attached to the oligonucleotide/nanoparticle modified surface through DNA hybridization interactions with the linking oligonucleotide, a melting curve was performed. For the melting experiment, the substrate was placed in a cuvette containing 1 mL of hybridization buffer and the same apparatus used in Example 2, part B, was used. The absorbance signal due to the nanoparticles (520 nm) was monitored as the temperature of the substrate was increased at a rate of 0.5°C per minute. The nanoparticle signal dramatically dropped when the temperature passed 60°C. See Figure 14B. A first derivative of the signal showed a melting temperature of 62°C, which corresponds with the temperature seen for the three DNA sequences hybridized in solution without nanoparticles. See Figure 14B.

**Example 7: Assays Using Nanoparticle-Oligonucleotide Conjugates**

The detection system illustrated in Figures 15A-G was designed so that the two probes 1 and 2 align in a tail-to-tail fashion onto a complementary target 4 (see Figures 15A-G). This differs from the system described in Example 5 where the two probes align contiguously on the target strand (see Figures 12A-F).

The oligonucleotide-gold nanoparticle conjugates 1 and 2 illustrated in Figures 15A-G were prepared as described in Example 3, except that the nanoparticles were redispersed in hybridization buffer (0.3 M NaCl, 10 mM phosphate, pH 7). The final nanoparticle-oligonucleotide conjugate concentration was estimated to be 13 nM by measuring the reduction in intensity of the surface plasmon band at 522 nm which gives rise to the red color of the nanoparticles. The oligonucleotide targets illustrated in

Figures 15A-G were purchased from the Northwestern University Biotechnology Facility, Evanston, IL.

When 150  $\mu$ L of hybridization buffer containing 13 nM oligonucleotide-nanoparticle conjugates 1 and 2 was mixed with 60 picomoles (6  $\mu$ L) of target 4, the solution color immediately changed from red to purple. This color change occurs as a result of the formation of large oligonucleotide-linked polymeric networks of gold nanoparticles, which leads to a red shift in the surface plasmon resonance of the nanoparticles. When the solution was allowed to stand for over 2 hours, precipitation of large macroscopic aggregates was observed. A 'melting analysis' of the solution with the suspended aggregates was performed. To perform the 'melting analysis', the solution was diluted to 1 ml with hybridization buffer, and the optical signature of the aggregates at 260 nm was recorded at one minute intervals as the temperature was increased from 25°C to 75°C, with a holding time of 1 minute/degree. Consistent with characterization of the aggregate as an oligonucleotide-nanoparticle polymer, a characteristic sharp transition (full width at half maximum,  $FW_{1/2}$  of the first derivative = 3.5°C) was observed with a "melting temperature" ( $T_m$ ) of 53.5°C. This compares well with the  $T_m$  associated with the broader transition observed for oligonucleotides without nanoparticles ( $T_m$  = 54°C,  $FW_{1/2}$  = ~13.5°C). The 'melting analysis' of the oligonucleotide solution without nanoparticles was performed under similar conditions as the analysis with nanoparticles, except that the temperature was increased from 10-80 °C. Also, the solution was 1.04  $\mu$ M in each oligonucleotide component.

To test the selectivity of the system, the  $T_m$  for the aggregate formed from the perfect complement 4 of probes 1 and 2 was compared with the  $T_m$ 's for aggregates formed from targets that contained one base mismatches, deletions, or insertions (Figures 15A-G). Significantly, all of the gold nanoparticle-oligonucleotide aggregates that contained imperfect targets exhibited significant, measurable destabilization when compared to the aggregates formed from the perfect complement, as evidenced by  $T_m$  values for the various aggregates (see Figures 15A-G). The solutions containing the

imperfect targets could easily be distinguished from the solution containing the perfect complement by their color when placed in a water bath held at 52.5°C. This temperature is above the  $T_m$  of the mismatched polynucleotides, so only the solution with the perfect target exhibited a purple color at this temperature. A 'melting analysis' was also  
5 performed on the probe solution which contained the half-complementary target. Only a minute increase in absorbance at 260 nm was observed.

Next, 2  $\mu$ L (20 picomoles) of each of the oligonucleotide targets (Figures 15A-G) were added to a solution containing 50  $\mu$ L of each probe (13 nM) in hybridization buffer. After standing for 15 minutes at room temperature, the solutions were transferred to a  
10 temperature-controlled water bath and incubated at the temperatures indicated in Table 4 below for five minutes. A 3  $\mu$ L sample of each reaction mixture was then spotted on a C-18 silica plate. Two control experiments were performed to demonstrate that the alignment of both probes onto the target is necessary to trigger aggregation and, therefore, a color change. The first control experiment consisted of both probes 1 and 2  
15 without target present. The second control experiment consisted of both probes 1 and 2 with a target 3 that is complementary to only one of the probe sequences (Figure 15B). The results are presented in Table 4 below. Pink spots signify a negative test, and blue spots signify a positive test.

Notably, the colorimetric transition that can be detected by the naked eye occurs  
20 over less than 1°C, thereby allowing one to easily distinguish the perfect target 4 from the targets with mismatches (5 and 6), an end deletion (7), and a one base insertion at the point in the target where the two oligonucleotide probes meet (8) (see Table 4). Note that the colorimetric transition  $T_c$  is close in temperature, but not identical, to  $T_m$ . In both controls, there were no signs of particle aggregation or instability in the solutions, as  
25 evidenced by the pinkish red color which was observed at all temperatures, and they showed negative spots (pink) in the plate test at all temperatures (Table 4).

The observation that the one base insertion target 8 can be differentiated from the fully complementary target 4 is truly remarkable given the complete complementarity of

the insertion strand with the two probe sequences. The destabilization of the aggregate formed from 8 and the nanoparticle probes appears to be due to the use of two short probes and the loss of base stacking between the two thymidine bases where the probe tails meet when hybridized to the fully complementary target. A similar effect was

5 observed when a target containing a three base pair insertion (CCC) was hybridized to the probes under comparable conditions, ( $T_m = 51^\circ\text{C}$ ). In the system described above in Example 5, targets with base insertions could not be distinguished from the fully complementary target. Therefore, the system described in this example is very favorable in terms of selectivity. This system also exhibited the same sensitivity as the system

10 described in Example 5, which is approximately 10 femtomoles without amplification techniques.

The results indicate that any one base mismatch along the target strand can be detected, along with any insertions into the target strand. Importantly, the temperature range over which a color change can be detected is extremely sharp, and the change

15 occurs over a very narrow temperature range. This sharp transition indicates that there is a large degree of cooperativity in the melting process involving the large network of colloids which are linked by the target oligonucleotide strands. This leads to the remarkable selectivity as shown by the data.

20

TABLE 4

Reactants (probes) + target	Results (color)					
	RT	47.6°C	50.5°C	51.4°C	52.7°C	54.5°C
(1 + 2)	pink	pink	pink	pink	pink	pink
(1 + 2) + 3	pink	pink	pink	pink	pink	pink
(1 + 2) + 4	blue	blue	blue	blue	blue	pink
(1 + 2) + 5	blue	blue	blue	pink	pink	pink
(1 + 2) + 6	blue	pink	pink	pink	pink	pink
(1 + 2) + 7	blue	blue	blue	blue	pink	pink
(1 + 2) + 8	blue	blue	pink	pink	pink	pink

**Example 8: Assays Using Nanoparticle-Oligonucleotide Conjugates**

A set of experiments were performed involving hybridization with 'filler' duplex oligonucleotides. Nanoparticle-oligonucleotide conjugates 1 and 2 illustrated in Figure 16A were incubated with targets of different lengths (24, 48 and 72 bases in length) and complementary filler oligonucleotides, as illustrated in Figures 16A-C. Otherwise, the conditions were as described in Example 7. Also, the oligonucleotides and nanoparticle-oligonucleotide conjugates were prepared as described in Example 7.

As expected, the different reaction solutions had markedly different optical properties after hybridization due to the distance-dependent optical properties of the gold nanoparticles. See Table 5 below. However, when these solutions were spotted onto a C-18 TLC plate, a blue color developed upon drying at room temperature or 80°C, regardless of the length of the target oligonucleotide and the distance between the gold nanoparticles. See Table 5. This probably occurs because the solid support enhances aggregation of the hybridized oligonucleotide-nanoparticle conjugates. This demonstrates that by spotting solutions onto the TLC plate, the distance between the gold nanoparticles can be substantial (at least 72 bases), and colorimetric detection is still possible.

**TABLE 5**

Target Length	Results (Color)	
	<u>Solution</u>	<u>TLC Plate</u>
24 bases	Blue	Blue
48 bases	Pink	Blue
72 bases	Pink	Blue
Probes 1 + 2 only	Pink	Pink

The color changes observed in this and other examples occur when the distance between the gold nanoparticles (the interparticle distance) is approximately the same or less than the diameter of the nanoparticle. Thus, the size of the nanoparticles, the size of

the oligonucleotides attached to them, and the spacing of the nanoparticles when they are hybridized to the target nucleic acid affect whether a color change will be observable when the oligonucleotide-nanoparticle conjugates hybridize with the nucleic acid targets to form aggregates. For instance, gold nanoparticles with diameters of 13 nm will  
5 produce a color change when aggregated using oligonucleotides attached to the nanoparticles designed to hybridize with target sequences 10-35 nucleotides in length. The spacing of the nanoparticles when they are hybridized to the target nucleic acid adequate to give a color change will vary with the extent of aggregation, as the results demonstrate. The results also indicate that the solid surface enhances further aggregation  
10 of already-aggregated samples, bringing the gold nanoparticles closer together.

The color change observed with gold nanoparticles is attributable to a shift and broadening of the surface plasmon resonance of the gold. This color change is unlikely for gold nanoparticles less than about 4 nm in diameter because the lengths of the oligonucleotides necessary for specific detection of nucleic acid would exceed the  
15 nanoparticle diameter.

Example 9: Assays Using Nanoparticle-Oligonucleotide Conjugates

Five microliters of each probe 1 and 2 (Figure 12A) were combined to a final concentration of 0.1 M NaCl with buffer (10 mM phosphate, pH 7), and 1 microliter of  
20 human urine was added to the solution. When this solution was frozen, thawed, and then spotted on a C-18 TLC plate, a blue color did not develop. To a similar solution containing 12.5 microliters of each probe and 2.5 microliters of human urine, 0.25 microliters (10 picomoles) of target 3 (Figure 12A) was added. The solution was frozen, thawed and then spotted onto a C-18 TLC plate, and a blue spot was obtained.

25 Similar experiments were performed in the presence of human saliva. A solution containing 12.5 microliters of each probe 1 and 2 and 0.25 microliters of target 3 was heated to 70°C. After cooling to room temperature, 2.5 microliters of a saliva solution (human saliva diluted 1:10 with water) was added. After the resultant solution was



frozen, thawed and then spotted onto a C-18 TLC plate, a blue spot was obtained, indicating hybridization of the probes with the target. In control experiments with no target added, blue spots were not observed.

5 Example 10: Assays Using Nanoparticle-Oligonucleotide Conjugates

An assay was performed as illustrated in Figure 13A. First, glass microscope slides, purchased from Fisher scientific, were cut into approximately 5 x 15 mm pieces, using a diamond tipped scribing pen. Slides were cleaned by soaking for 20 minutes in a solution of 4:1 H<sub>2</sub>SO<sub>4</sub>:H<sub>2</sub>O<sub>2</sub> at 50°C. Slides were then rinsed with copious amounts of  
10 water, then ethanol, and dried under a stream of dry nitrogen. Thiol-modified DNA was adsorbed onto the slides using a modified procedure reported in the literature (Chrisey et al., *Nucleic Acids Res.*, 24, 3031-3039 (1996) and Chrisey et al., *Nucleic Acids Res.*, 24, 3040-3047 (1996)). First, the slides were soaked in a 1% solution of trimethoxysilylpropyldiethyltri-  
15 amine (DETA, purchased from United Chemical Technologies, Bristol, PA) in 1 mM acetic acid in Nanopure water for 20 minutes at room temperature. The slides were rinsed with water, then ethanol. After drying with a dry nitrogen stream, the slides were baked at 120°C for 5 minutes using a temperature-controlled heating block. The slides were allowed to cool, then were soaked in a 1 mM succinimidyl 4-(maleimidophenyl)-butyrate (SMPB, purchased from Sigma Chemicals)  
20 solution in 80:20 methanol:dimethoxysulfoxide for 2 hours at room temperature. After removal from the SMPB solution and rinsing with ethanol, amine sites that were not coupled to the SMPB crosslinker were capped as follows. First, the slides were soaked for 5 minutes in a 8:1 THF:pyridine solution containing 10% 1-methyl imidazole. Then the slides were soaked in 9:1 THF:acetic anhydride solution for five minutes. These  
25 capping solutions were purchased from Glen Research, Sterling, VA. The slides were rinsed with THF, then ethanol, and finally water.

DNA was attached to the surfaces by soaking the modified glass slides in a 0.2 OD (1.7 μM) solution containing freshly purified oligonucleotide (3' thiol

ATGCTCAACTCT [SEQ ID NO:33]). After 12 hours of soaking time, the slides were removed and rinsed with water.

To demonstrate the ability of an analyte DNA strand to bind nanoparticles to the modified substrate, a linking oligonucleotide was prepared. The linking oligonucleotide was 24 bp long (5' TACGAGTTGAGAATCCTGAATGCG [SEQ ID NO:34]) with a sequence containing a 12 bp end that was complementary to the DNA already adsorbed onto the substrate surface. The substrate was then soaked in a hybridization buffer (0.5 M NaCl, 10 mM phosphate buffer pH 7) solution containing the linking oligonucleotide (0.4 OD, 1.7  $\mu$ M) for 12 hours. After removal and rinsing with similar buffer, the substrate was soaked in a solution containing 13 nm diameter gold nanoparticles which had been modified with an oligonucleotide (TAGGACTTACGC 5' thiol [SEQ ID NO:35]) that is complementary to the unhybridized portion of the linking oligonucleotide attached to the substrate. After 12 hours of soaking, the substrate was removed and rinsed with the hybridization buffer. The glass substrate's color had changed from clear and colorless to a transparent pink color. See Figure 19A.

Additional layers of nanoparticles were added to the slides by soaking the slides in a solution of the linking oligonucleotide as described above and then soaking in a solution containing 13 nm gold nanoparticles having oligonucleotides (3' thiol ATGCTCAACTCT [SEQ ID NO:33]) attached thereto. After soaking for 12 hours, the slides were removed from the nanoparticle solution and rinsed and soaked in hybridization buffer as described above. The color of the slide had become noticeably more red. See Figure 19A. A final nanoparticle layer was added by repeating the linking oligonucleotide and nanoparticle soaking procedures using 13 nm gold nanoparticles which had been modified with an oligonucleotide (TAGGACTTACGC 5' thiol [SEQ ID NO:35]) as the final nanoparticle layer. Again, the color darkened, and the UV-vis absorbance at 520 nm increased. See Figure 19A.

To verify that the oligonucleotide modified gold nanoparticles were attached to the oligonucleotide modified surface through DNA hybridization interactions with the

linking oligonucleotide, a melting curve was performed. For the melting experiment, a slide was placed in a cuvette containing 1.5 mL of hybridization buffer, and an apparatus similar to that used in Example 2, part B, was used. The absorbance signal due to the nanoparticles (520 nm) was monitored at each degree as the temperature of the substrate was increased from 20°C to 80°C, with a hold time of 1 minute at each integral degree. The nanoparticle signal dramatically dropped when the temperature passed 52°C. See Figure 19B. A first derivative of the signal showed a melting temperature of 55°C, which corresponds with the temperature seen for the oligonucleotide-nanoparticle conjugates and linking oligonucleotides hybridized in solution. See Figure 19B.

10

Example 11: Assay of a Polyribonucleotide Using Nanoparticle-Oligonucleotide Conjugates as Probes

The previous Examples utilized oligo-deoxyribonucleotides as targets in the assays. The present example demonstrates that the nanoparticle-oligonucleotide conjugates can also be used as probes in assaying a polyribonucleotide. The experiment was carried out by adding 1 µL of a solution of poly(rA) (0.004 A<sub>260</sub> Units) to 100 µL of gold nanoparticles (~ 10 nM in particles) conjugated to dT<sub>20</sub> (a 20-mer oligonucleotide containing thymidylate residues) through a mercaptoalkyl linker at the 5'-terminus. The conjugation procedure was that described in Example 3. Following freezing in a Dry Ice/isopropyl alcohol bath, thawing at room temperature, and spotting on a C18 TLC plate as described in Example 4, a blue spot characteristic of aggregation of the nanoparticles by hybridization was observed. Control experiments carried out in absence of the target gave a pink spot, rather than a blue spot.

15

20

25 Example 12: Assay for Protective Antigen DNA Segment of Anthrax Using Nanoparticle-Oligonucleotide Conjugates

In many cases amplification of a double-stranded DNA target by PCR is needed to provided sufficient material for an assay. The present example demonstrates that the nanoparticle-oligonucleotide conjugates can be used to assay for a DNA strand in the

presence of its complement (*i.e.*, assaying for a single strand after thermal dehybridization of a double-stranded target) and can recognize and specifically bind to an amplicon obtained from a PCR reaction.

A PCR solution containing a 141 base pair duplex amplicon of the Protective Antigen segment of Anthrax was provided by the Navy (sequence given in Figure 23). The assay for this amplicon was carried out by isolating the DNA from 100  $\mu$ L of the PCR solution using a Qiaquick Nucleotide Removal Kit (Qiagen, Inc., Santa Clarita, CA) and the standard protocol for this kit, with the exception that elution of the DNA was effected with 10 mM phosphate buffer at pH 8.5, rather than with the buffer provided with the kit. The eluant was then evaporated to dryness on a Speed Vac (Savant). To this residue was added 5  $\mu$ L of a master mix prepared by mixing equal volumes of each of two solutions of two different oligonucleotide-nanoparticle probes (see Figure 23). Each oligonucleotide-nanoparticle probe was prepared as described in Example 3. The solutions of the probes which were combined to form the master mix were prepared by adding 10  $\mu$ L of 2 M NaCl and 5  $\mu$ L of oligonucleotide blocker solution (50 pmoles of each Blocker oligonucleotide (see Figure 23 and below) in a 0.3 M NaCl, 10 mM phosphate, pH 7.0., solution) to 5  $\mu$ L of full-strength (about 10 nM) nanoparticle-oligonucleotide solution. The amplicon-probe mixture was heated to 100°C for 3 minutes, then frozen in a DRY ICE/ethanol bath and allowed to come to room temperature. A small aliquot (2  $\mu$ L) was spotted on a C18 TLC plate and allowed to dry. A strong blue spot indicative of hybridization was obtained.

Control tests carried out in the same manner in absence of the amplicon target DNA, in the absence of Probe 1, in the absence of Probe 2, or in the absence of the sodium chloride, were all negative, that is, gave a pink spot. Similarly a test carried out using probes 1 and 2 with a PCR amplicon derived from the Lethal Factor segment of Anthrax in place of the Protective Antigen Segment was negative (pink spot). These controls confirmed that both probes were essential, that salt conditions appropriate for hybridization were needed, and that the test was specific for the specified target

sequence.

The oligonucleotide Blockers were added to inhibit binding of the second strand of the initial duplex target (*i.e.*, the strand complementary to the target strand) to regions of the target nucleic acid strand outside the segment that binds to the probes (see Figure 5 23 for sequences), since such binding interferes with binding of the nanoparticle oligonucleotide probes to the target strand. In this example, the Blocker oligonucleotides were complementary to the single-stranded target in regions not covered by the probes. An alternative scheme is to use blocker oligonucleotides that are complementary to the PCR complementary strand (the strand complementary to the target strand) outside the 10 region that competes with the probe oligonucleotides.

**Example 13: Direct assay of PCR Amplicons without isolation of the amplicons from the PCR solution**

The procedure described in Example 12 involved separation of the PCR amplicon 15 from the PCR solution before addition of the nanoparticle-oligonucleotide probes. For many purposes it would be desirable to be able to carry out the assay directly in the PCR solution without preliminary isolation of the polynucleotide products. A protocol for such an assay has been developed and is described below. This protocol has been performed successfully with several PCR products derived under standard conditions using a 20 GeneAmp PCR Reagent Kit with Amplitaq DNA polymerase.

To 50  $\mu\text{L}$  of the PCR sample solution, 5  $\mu\text{L}$  of a mixture of two gold nanoparticle-oligonucleotide probes (0.008  $A_{520}$  Units of each) was added, followed by addition of a solution made up from 1  $\mu\text{L}$  of Blocker oligonucleotides (10 pmoles each), 5  $\mu\text{L}$  of 5 M NaCl, and 2  $\mu\text{L}$  of 150 mM  $\text{MgCl}_2$ . This mixture was heated for 2 minutes 25 at 100°C to separate the strands of the duplex target, the tube was immersed directly in a cold bath (*e.g.*, Dry Ice/ethanol) for 2 minutes, then removed, and the solution allowed to thaw at room temperature (the freeze-thaw cycle facilitates hybridization of the probes with the target oligonucleotide). Finally, a few  $\mu\text{L}$  of the solution were spotted on a plate

e.g., C18 RP TLC plate, a silica plate, a nylon membrane, etc.). As usual, blue color signifies the presence of the targeted nucleic acid in the PCR solution; a pink color is negative for this target.

5 Example 14: Direct Recognition of Duplex Oligonucleotides Without Dehybridization, Using Assembly of Nanoparticle-Oligonucleotide Conjugates

In the previous Examples, double-stranded targets were dehybridized by heating to generate single strands which interacted with single-stranded oligonucleotide probes bound to nanoparticles. The present example demonstrates that in cases where triple-  
10 stranded complexes can form, double-stranded oligonucleotide sequences can be recognized by the nanoparticle probes without prior dehybridization of the target.

Tests were carried out with two different systems-- polyA:polyU and dA<sub>40</sub>:dT<sub>40</sub> -- by adding 1  $\mu$ L of a solution containing 0.8 A<sub>260</sub> Units of the target duplex in 100  $\mu$ L of buffer (0.1 M NaCl, 10 mM phosphate, pH 7.0) to 100  $\mu$ L of a colloidal solution of Au-  
15 sdT<sub>20</sub> nanoparticle-oligonucleotide conjugate (~10 nM in particles; see Example 11) in 0.3 M NaCl, 10 mM phosphate buffer at pH 7.0. Subsequent quick freezing by immersing the tube in a Dry Ice/isopropyl alcohol bath and thawing by removing the tube from the bath and letting it stand at room temperature (22°C), followed by spotting 3  $\mu$ L of the solution on a C18 TLC plate, afforded a blue spot characteristic of hybridization  
20 and aggregation of the nanoparticles.

The rationale for this test is that the nanoparticle probes (bearing pyrimidine oligonucleotides in this example) bind in a sequence specific manner at purine oligonucleotide/pyrimidine oligonucleotide sites along the duplex target. Since many binding sites are available on each double stranded entity, the binding leads to formation  
25 of an aggregate of nanoparticles. The results show that this assay, based on formation of triple-stranded complexes involving the nanoparticle probes, works both for oligoribo- and oligodeoxyribonucleotide double-stranded targets.

Example 15: Assay Employing Both Fluorescence And Colorimetric Detection

All hybridization experiments were performed in a 0.3 M NaCl, 10 mM phosphate, pH 7.0, buffer solution. AcetatePlus™ filtration membranes (0.45 μm) were purchased from Micron Separations Inc., Westboro, MA. Alkylamine-functionalized latex microspheres (3.1 μm) were purchased from Bangs Laboratories, Fishers IN. Fluorophore-labeled oligonucleotides functionalized with alkylamino groups at the 3'-terminus were synthesized using standard phosphoramidite chemistry (Eckstein, ed., in *Oligonucleotides and Analogues*, 1st ed., Oxford University, New York, N.Y. 1991) with an Amino-Modifier C7 CPG solid support (Glen Research) and a 5'-fluorescein phosphoramidite (6-FAM, Glen Research) on an Expedite 8909 synthesizer and were purified by reverse phase HPLC. They were attached to the amine-functionalized latex microspheres by means of diisothiocyanate coupling to yield a dithiourea linkage as described in Charreyre et al., *Langmuir*, 13, 3103-3110 (1997). Briefly, a DMF solution of a one thousand fold excess of 1,4-phenylene diisothiocyanate was added to an aqueous borate buffer solution (0.1 M, pH 9.3) of the amino-modified oligonucleotide. After several hours, the excess 1,4-phenylene diisothiocyanate was extracted with butanol and the aqueous solution lyophilized. The activated oligonucleotides were redissolved in borate buffer and reacted with the amino-functionalized latex microspheres in a carbonate buffer (0.1 M, pH 9.3, 1 M NaCl). After 12 hrs, the particles were isolated by centrifugation and washed three times with buffered saline solution (0.3 M NaCl, 10 mM phosphate pH 7.0). The 5'-oligonucleotide-modified gold nanoparticle probes were prepared as described in Example 3.

The target oligonucleotide (1-5 μl, 3 nM) was added to 3 μl of fluorophore-labeled oligonucleotide-modified latex microsphere probe solution (3.1 μm; 100 fM). After 5 minutes, 3 μl of the 5' oligonucleotide-modified gold nanoparticle probe solution (13 nm; 8 nM) were added to the solution containing the target and latex microsphere probes. Upon standing for an additional 10 minutes, the solution containing both probes and target was vacuum-filtered through the AcetatePlus membrane. The membrane

retained the relatively large latex particles and allowed any non-hybridized gold nanoparticle probes to pass through. In the presence of a sufficient concentration of target, the latex microspheres and the gold nanoparticles hybridized with the target, and a red spot was observed on the membrane (positive result). A control experiment was always carried out where the aliquot of solution containing the target oligonucleotide was replaced by an equal volume of water. In this case, a white spot was left on the membrane (negative result). For a 24-base-pair model system, using the unaided eye, 3 femtomoles of target oligonucleotide could be detected colorimetrically.

A double-stranded target oligonucleotide (1-5  $\mu$ l, 20 nM), 3  $\mu$ l of a solution of fluorophore-labeled- oligonucleotide-latex microspheres (3.1  $\mu$ m; 100 fM) and 3  $\mu$ l of a solution of 5'-oligonucleotide-gold nanoparticles (13 nm; 8 nM) were combined and heated to 100 °C for 3 minutes. Then, the solution was immediately frozen by immersing the reaction vessel containing it in a liquid N<sub>2</sub> bath for 3 minutes. This solution was then thawed at room temperature and filtered as described above. For a 24-base pair model system, using the unaided eye, 20 femtomoles of duplex target oligonucleotide could be detected colorimetrically.

When monitored by fluorescence, the detection method described above proved to be difficult due to background fluorescence from the membrane. This problem was overcome by "washing" the latex microspheres by centrifugation to remove excess gold nanoparticle probes before spotting an aliquot on a reverse-phase TLC plate. The hybridization experiments were performed as described above. After hybridization was effected between the probes and target, 10  $\mu$ l of buffer were added to the solution, which was subsequently centrifuged at 10,000 x g for 2 minutes. The supernatant was removed, and 5  $\mu$ l of buffer were added to help resuspend the precipitate. A 3  $\mu$ l aliquot was then spotted on a reverse-phase TLC plate. For both single-stranded and duplex target oligonucleotides, 25 femtomoles could be detected colorimetrically by the naked eye. Fluorescent spots could be visualized by the naked eye with a hand-held UV-lamp until the target amount in the 3  $\mu$ l aliquot used to form the spot was as low as 50 femtomoles.



It is believed that optimization of this system will allow for detection of even lower amounts of target nucleic acid.

Example 16: Assays Employing Silver Staining

5 DNA hybridization tests on oligonucleotide-modified substrates are commonly used to detect the presence of specific DNA sequences in solution. The developing promise of combinatorial DNA arrays for probing genetic information illustrates the importance of these heterogeneous sequence assays to future science. In most assays, the hybridization of fluorophore-labeled targets to surface-bound probes is monitored by  
10 fluorescence microscopy or densitometry. Although fluorescence detection is very sensitive, its use is limited by the expense of the experimental equipment and by background emissions from most common substrates. In addition, the selectivity of labeled oligonucleotide targets for perfectly complementary probes over those with single-base mismatches is poor, preventing the use of surface hybridization tests for  
15 detection of single nucleotide polymorphisms. A detection scheme which improved upon the simplicity, sensitivity and selectivity of fluorescent methods could allow the full potential of combinatorial sequence analysis to be realized. The present invention provides such improved detection schemes.

For instance, oligonucleotide-modified gold nanoparticles and unmodified DNA  
20 target could be hybridized to oligonucleotide probes attached to a glass substrate in a three-component sandwich assay (see Figures 25A-B). Note that the nanoparticles can either be individual ones (see Figure 25A) or "trees" of nanoparticles (see Figure 25B). The "trees" increase signal sensitivity as compared to the individual nanoparticles, and the hybridized gold nanoparticles "trees" often can be observed with the naked eye as  
25 dark areas on the glass substrate. When "trees" are not used, or to amplify the signal produced by the "trees," the hybridized gold nanoparticles can be treated with a silver staining solution. The "trees" accelerate the staining process, making detection of target nucleic acid faster as compared to individual nanoparticles.

The following is a description of one specific system (illustrated in Figure 25A). Capture oligonucleotides (3' - HS(CH<sub>2</sub>)<sub>3</sub> - A<sub>10</sub>ATGCTCAACTCT; SEQ ID NO: 43) were immobilized on a glass substrate as described in Example 10. A target oligonucleotide (5' - TACGAGTTGAGAATCCTGAATGCG - 3', SEQ ID NO: 44, concentrations given  
5 below in Table 6 for each experiment) was hybridized with the capture oligonucleotides in 0.3 M NaCl, 10 mM phosphate buffer as described in Example 10. The substrate was rinsed twice with the same buffer solution and immersed in a solution containing gold nanoparticle probes functionalized with target-complementary DNA (5' -  
10 HS(CH<sub>2</sub>)<sub>6</sub>A<sub>10</sub>CGCATTTCAGGAT, SEQ ID NO: 45)(preparation described in Example 3) for 12 hours. Next, the substrate was rinsed copiously with 0.3 M NaNO<sub>3</sub> to remove Cl<sup>-</sup>. The substrate was then developed with silver staining solution (1:1 mixture of Silver Enhancer Solutions A and B, Sigma Chemical Co., # S-5020 and # S-5145) for 3 minutes. Greyscale measurements were made by scanning the substrate on a flatbed scanner (normally used for scanning documents into a computer) linked to a computer  
15 loaded with software capable of calculating greyscale measurements (e.g., Adobe Photoshop). The results are presented in Table 6 below.

TABLE 6

Target DNA Concentration	Mean Greyscale	Standard Deviation
10 nM	47.27	2.10
5 nM	53.45	0.94
2 nM	54.56	1.17
1 nM	59.98	1.82
500 pM	61.61	2.26
200 pM	90.06	3.71
100 pM	99.04	2.84
50 pM	135.20	7.49
20 pM	155.39	3.66
None (control)	168.16	10.03

Example 17: Assemblies Containing Quantum Dots

5            This example describes the immobilization of synthetic single-stranded DNA on semiconductor nanoparticle quantum dots (QDs). Native CdSe/ZnS core/shell QDs (~4 nm) are soluble only in organic media, making direct reaction with alkythiol-terminated single-stranded DNA difficult. This problem was circumvented by first capping the QDs with 3-mercaptopropionic acid. The carboxylic acid group was then deprotonated with 4-

10 (dimethylamino)pyridine, rendering the particles water soluble, and facilitating reaction of the QDs with either 3'-propylthiol- or 5'-hexylthiol-modified oligonucleotide sequences. After DNA modification, the particles were separated from unreacted DNA by dialysis. A "linker" DNA strand was then hybridized to surface-bound sequences, generating extended assemblies of nanoparticles. The QD assemblies, which were

15 characterized by TEM, UV/Visible spectroscopy, and fluorescence spectroscopy, could be reversibly assembled by controlling the temperature of the solution. The temperature dependent UV-Vis spectra were obtained for the novel QD assemblies and composite aggregates formed between QDs and gold nanoparticles (~13 nm).

### A. General Methods

Nanopure water (18.1 M $\Omega$ ) prepared using a NANOpure ultrapure water purification system was employed throughout. Fluorescence spectra were obtained using a Perkin Elmer LS 50 B Luminescence Spectrometer. Melting analyses were performed using a HP 8453 diode array spectrophotometer equipped with a HP 9090a Peltier Temperature Controller. Centrifugation was carried out using either an Eppendorf 5415C centrifuge or a Beckman Avanti 30 centrifuge. TEM images were acquired using a Hitachi HF-2000 field emission TEM operating at 200 kV.

### B. Preparation Of Oligonucleotide-QD Conjugates

10 Synthetic methodologies for semiconductor quantum dots (QDs) have improved greatly in recent years, and for some materials, most notably CdSe, monodisperse samples of pre-determined size can now be prepared with relative ease. Murray et al., *J. Am. Chem. Soc.* **1993**, *115*, 8706; Hines, et al., *J. Phys. Chem.* **1996**, *100*, 468. As a result, the unique electronic and luminescent properties of these particles have been studied extensively (see, Alivisatos, *J. Phys. Chem.* **1996**, *100*, 13226, and references therein; Klein et al., *Nature* **1997**, 699; Kuno et al., *J. Chem. Phys.* **1997**, *106*, 9869; Nirmal et al., *Nature* **1996**, *383*, 802), potentially paving the way for QDs to be employed in diverse technologies, such as light-emitting diodes (Schlamp et al., *J. Appl. Phys.* **1997**, *82*, 5837; Dabbousi et al., *Appl. Phys. Lett.* **1995**, *66*, 1316) and as non-radioactive biological labels (Bruchez et al., *Science* **1998**, *281*, 2013; Chan et al., *Science* **1998**, *281*, 2016). However, many applications will require that the particles be arranged spatially on a surface or organized into three-dimensional materials (Vossmeier et al., *J. Appl. Phys.* **1998**, *84*, 3664). Moreover, the ability to organize one or more types of nanoparticles into superlattice structures (Murray et al., *Science* **1995**, *270*, 1335) would allow for the construction of completely new types of hybrid materials with new and potentially interesting and useful properties.

DNA is the ideal synthon for programming the assembly of nanoscale building blocks into periodic two- and three-dimensional extended structures. The many attributes

of DNA, which include ease of synthesis, extraordinary binding specificity, and virtually unlimited programmability by virtue of nucleotide sequence, can be exploited for the use of QD assembly.

The modification of QDs with DNA has proven to be more difficult than for gold nanoparticles. The common methods for preparing highly luminescent CdSe QDs yield materials that are coated with a mixture of trioctylphosphine oxide (TOPO) and trioctylphosphine (TOP). As a result, these QDs are soluble only in non-polar solvents, making them difficult to functionalize with highly charged DNA strands by direct reaction. This difficulty has been overcome by the method described below, which is the first successful modification of semiconductor nanoparticles with single-stranded DNA. It should be noted that others, in elegant studies, have looked at the interactions between QDs and duplex DNA, but these studies did not make use of the sequence specific binding properties of DNA to direct the assembly of extended QD structures. Coffey et al., *Appl. Phys. Lett.*, 1996, 69, 3851; Mahtab et al., *J. Am. Chem. Soc.*, 1996, 118, 7028.

Since the surface of CdSe/ZnS core/shell QDs binds organic thiols, it was desired to modify these semiconductor particles with alkylthiol-terminated DNA strands by a substitution reaction. The lack of water solubility of these QDs, though, hindered such an approach. Two different methods recently have been reported for making QDs water soluble, allowing for the immobilization of protein structures on the QD surfaces. One involves encapsulation of the core/shell structures with a silica layer (Bruchez et al., *Science* 1998, 281, 2013), while the other utilizes mercaptoacetic acid both to stabilize the particles and provide water solubility (Chan et al., *Science* 1998, 281, 2016). The procedure described in this example, which produces remarkably stable colloid under DNA hybridization conditions, utilizes 3-mercaptopropionic acid to passivate the QD surface.

An excess of 3-mercaptopropionic acid (0.10 mL, 1.15 mmol; Aldrich) was added by syringe to a suspension of ~20 mg of TOP/TOPO stabilized CdSe/ZnS QDs (prepared as described in Hines, et al., *J. Phys. Chem.* 1996, 100, 468) in 1.0 mL of N,N,-dimethyl

formamide (DMF; Aldrich) generating a clear, dark orange solution containing 3-mercaptopropionic acid functionalized QDs. The reaction occurred quickly. For subsequent reactions, excess 3-mercaptopropionic acid was not removed, and the particles were stored at room temperature in DMF.

5            However, to characterize the QDs, a portion of the sample was purified by removing unreacted 3-mercapto-propionic acid as follows. A 0.50 mL sample was centrifuged (4 hours at 30,000 rpm), and the supernatant was removed. The remaining solution was washed with ~0.3 mL of DMF and recentrifuged. This step was repeated two additional times before recording the FTIR spectrum. FTIR (polyethylene card,  
10 3M): 1710  $\text{cm}^{-1}$  (s), 1472  $\text{cm}^{-1}$  (m), 1278  $\text{cm}^{-1}$  (w), 1189  $\text{cm}^{-1}$  (m), 1045  $\text{cm}^{-1}$  (w), 993  $\text{cm}^{-1}$  (m), 946  $\text{cm}^{-1}$  (w), 776  $\text{cm}^{-1}$  (m), 671  $\text{cm}^{-1}$  (m). Unlike the TOP/TOPO stabilized native QDs, the 3-mercaptopropionic acid modified QDs exhibited a characteristic  $\nu_{\text{CO}}$  band at 1710  $\text{cm}^{-1}$  for the surface bound propionic acid.

15            Although the 3-mercaptopropionic acid modified QDs were practically insoluble in water, their solubility could be significantly enhanced by deprotonating the surface bound mercaptopropionic acid sites with 4-(dimethylamino)pyridine (DMAP; Aldrich) as described in the next paragraph. The QDs then dispersed readily in water, producing orange solutions that were stable for up to a week at room temperature.

20            To attach oligonucleotides to QDs, 150  $\mu\text{L}$  (optical density at 530 nm = 21.4) of a solution of the 3-mercaptopropionic acid functionalized particles in DMF were added to a solution of DMAP (8.0 mg, 0.065 mmol) in 0.4 mL of DMF. An orange precipitate was formed. It was separated by centrifugation (~30 seconds at 3000 rpm) and then dissolved in 1.0 mL of a solution of 3' propylthiol- or 5' hexylthiol-terminated oligonucleotides (1.0-2.0 ODs/mL; prepared as described in Example 1; sequences given below).

25            Precipitate (dissolved in water) was characterized by IR spectroscopy (polyethylene card, 3M). IR ( $\text{cm}^{-1}$ ): 1647 (m), 1559 (s), 1462 (m), 1214 (w), 719 (w), 478 (s). After standing for 12 hours, the oligonucleotide-containing solution was brought to 0.15 M NaCl, and the particles were aged for an additional 12 hours. The NaCl concentration was then

raised to 0.3 M, and the mixture was allowed to stand for a further 24-40 hours before dialyzing against PBS (0.3 M NaCl, 10 mM phosphate buffer, pH 7, 0.01% sodium azide) using a 100 kDa membrane (Spectra/Por Cellulose Ester Membrane). The dialysis was carried out over a period of 48 hours, during which time the dialysis bath was  
5 refreshed three times.

Oligonucleotide-QD conjugates prepared in this manner displayed indefinite aqueous stability. Moreover, the colloid remained strongly fluorescent, with a sharp [full width at half maximum (FWHM) = 33 nm], symmetrical emission at 546 nm (indicative of about 3.2 nm CdSe core; Murray et al., *J. Am. Chem. Soc.* 1993, 115, 8706).

10 Two different oligonucleotide-QD conjugates were prepared by this protocol and stored in PBS. One was modified with a 22mer, comprised of a propylthiol functionality at the 3'-end, a 12mer capture sequence, and an intervening 10 base (all A) spacer: 5'-TCTCAACTCGTAA<sub>10</sub>-(CH<sub>2</sub>)<sub>3</sub>-SH [SEQ ID NO: 46]. The other employed a 5'-hexylthiol-terminated sequence, also with a 10 base (all A) spacer, and a 12mer capture  
15 sequence which was non-complementary with the 3'-propylthiol sequence: 5'-SH-(CH<sub>2</sub>)<sub>6</sub>-A<sub>10</sub>CGCATTTCAGGAT-3' [SEQ ID NO: 47].

### C. Preparation Of QD Assemblies

When approximately equal quantities of these two oligonucleotides (200 $\mu$ L, OD<sub>530</sub>=0.224 and 0.206, respectively) were mixed and then combined with 6 $\mu$ L (60  
20 pmol) of a solution of a complementary linking 24mer sequence (5'-TACGAGTTGAGAATCCT-GAATGCG-3', SEQ ID NO: 48), QD assemblies formed within 20-30 minutes at room temperature, Figure 26. Faster linking took place when the mixture was frozen (-78° C) and then allowed to warm slowly to room temperature.

The clusters generated were not large enough to settle out of solution. However,  
25 they could be separated by centrifugation at relatively low speeds (10,000 RPM for 10 min), as compared with the unlinked particles (30,000 RPM for 2-3 hours).

The decrease in fluorescence upon hybridization was determined by integration of the fluorescence signal (320 nm excitation wavelength) from 475 nm to 625 nm of 4 pairs

of samples. Each pair was prepared in the following manner. A solution of 3' propylthiol-terminated DNA-modified particles (30  $\mu$ L, optical density at 530 nm = 0.224) was combined with a solution of 5' hexylthiol-terminated DNA-modified QDs (30  $\mu$ L, optical density at 530 nm = 0.206) in an Eppendorf centrifuge tube, and then diluted  
5 with 140  $\mu$ L of PBS. The mixture was then split into two equal portions, and complementary "linker" DNA (3  $\mu$ L, 30 pmol) was added to one, while non-complementary "linker" DNA (5'-CTACTTAGATCCGAGTGCCCACAT-3', SEQ ID NO: 49) (3  $\mu$ L, 30 pmol) was added to the other. All eight of the samples were then frozen in a dry ice/acetone bath (-78°C), after which they were removed from the bath  
10 and allowed to warm slowly to room temperature. To estimate the change in fluorescence efficiency upon hybridization, the fluorescence intensities of the "target" (complementary "linker") samples were adjusted to account for the difference in absorbance at 320 nm from the corresponding control samples, which contained non-complementary "linker".

15 The results showed that hybridization of QD/QD assemblies was accompanied by a decrease in integrated fluorescence intensity by an average of  $26.4 \pm 6.1\%$ , and approximately 2 nm red shift of the emission maximum, presumably due to cooperative effects between QDs, Figure 27A. Interestingly, Bawendi, *et al.* noticed a similar, albeit slightly larger, red shift when comparing the fluorescence of close-packed QDs and  
20 widely separated dots isolated in a frozen matrix (Murray et al., *Science* 1995, 270, 1335). These changes in the fluorescence spectra may be an indication of excimer formation between QDs, but the exact nature of such a complex is still largely a matter of speculation. As expected, no aggregation was observed when the "linker" was missing or not complementary, or when either one of the two types of particles was absent.

25 The "melting" behavior of the DNA was monitored by observing the UV-Vis spectra of the aggregates as a function of temperature. For this "melting" analysis, the precipitate containing the QD/QD assemblies was centrifuged at 10,000 rpm for 10 minutes, washed with 7  $\mu$ L of PBS, recentrifuged, and suspended in 0.7 mL of PBS. The



UV/Visible spectroscopic signature of the assemblies was recorded at two degree intervals as the temperature was increased from 25°C to 75°C, with a holding time of 1 minute prior to each measurement. The mixture was stirred at a rate of 500 rpm to ensure homogeneity throughout the experiment. Temperature vs extinction profiles were then compiled from the extinction at 600 nm. The first derivative of these profiles was used to determine the “melting” temperatures.

The results, Figure 27B ( $T_m = 57^\circ\text{C}$ ), demonstrated conclusively that DNA had been immobilized on the QD surfaces and that hybridization was responsible for the assembly process. The transition also was extremely sharp when compared with DNA alone (FWHM of the respective first derivatives: 4°C vs 9°C), which is consistent with the formation of an aggregate structure with multiple DNA links per particle. An increase in extinction was observed upon denaturation, most likely because of a screening effect whereby particles in the interiors of the assemblies are prevented from absorbing light by the surrounding QDs.

#### 15 D. Preparation Of QD/Gold Assemblies

With DNA-functionalized QDs in hand, the assembly of hybrid assemblies made from multiple types of nanoparticle building blocks became feasible. To prepare these hybrid assemblies, a solution of ~17 nM 3'-hexylthiol-modified 13 nm gold nanoparticles (30 µL, ~5 fmol; prepared as described in Example 3) was mixed with a solution of 5'-hexylthiol-terminated DNA-modified QDs (15 µL, optical density at 530 nm = 0.206) in an Eppendorf centrifuge tube. “Linker” DNA (5 µL, 50 pmol) was added, and the mixture cooled to -78°C, and then allowed to warm slowly to room temperature, generating a reddish-purple precipitate. No aggregation behavior was observed unless both types of particles and a complementary target were present. After centrifugation (1 min at 3,000 rpm) and removal of the supernatant, the precipitate was washed with 100 µL of PBS and recentrifuged.

For “melting” analysis, the washed precipitate was suspended in 0.7 mL of PBS. UV-Vis spectroscopy was used to follow the changes in the surface plasmon resonance of

the gold nanoparticles, so temperature vs. extinction profiles were compiled at 525 nm. Using the surface plasmon resonance of the gold nanoparticles provides a much more sensitive probe with which to monitor hybridization than does the UV-Vis spectroscopic signature of the QDs alone. Therefore, a "melting" experiment can be performed on a much smaller sample (-10% of the QD solution is needed), although the intensity of the plasmon band obscures the UV/Vis signal from the QDs. Similar to the pure QD system described above, a sharp (FWHM of the first derivative = 4.5°C) melting transition occurred at 58°C (see Figure 27D).

High resolution TEM images of these assemblies showed a network of gold nanoparticles interconnected by multiple QDs, Figure 27C. The QDs, which have a much lower contrast in the TEM image than gold nanoparticles, can be identified by their lattice fringes. They are just barely resolvable with the high resolution TEM, but clearly indicate the periodic structure of these composite assemblies and the role that DNA plays in forming them.

#### 15 E. Summary

The results described in this example definitively establish that the immobilization of DNA onto QD surfaces has been achieved and that these particles can now be used in combination with DNA under hybridization conditions. Using DNA-functionalized QDs, the first DNA-directed formation of QD and mixed gold/QD nanoparticle structures has been demonstrated. The successful modification of semiconductor QDs with DNA has significant implications for materials research, and the door is now open for more extensive inquiries into the luminescent, electronic, and chemical properties of these unique building blocks as they are incorporated into new and functional *multi-component* nanostructures and nanoscale materials.

25

Example 18: Methods of Synthesizing Oligonucleotide-Nanoparticle Conjugates And The Conjugates Produced By The Methods

A. General Methods

HAuCl<sub>4</sub>•3H<sub>2</sub>O and trisodium citrate were purchased from Aldrich chemical company, Milwaukee, WI. Gold wire, 99.999% pure, and titanium wire were purchased from Goldsmith Inc., Evanston, IL. Silicon wafers (100) with a 1 micron thick oxide layer were purchased from Silicon Quest International, Santa Clara, CA. 5'-thiol-modifier C6-phosphoramidite reagent, 3'-propylthiol modifier CPG, fluorescein phosphoramidite, and other reagents required for oligonucleotide synthesis were purchased from Glen Research, Sterling, VA. All oligonucleotides were prepared using an automated DNA synthesizer (Expedite) using standard phosphoramidite chemistry (Eckstein, F. *Oligonucleotides and Analogues*; 1st ed.; Oxford University Press, New York, 1991). Oligonucleotides containing only 5' hexylthiol modifications were prepared as described in Example 1. 5-(and 6)-carboxyfluorescein, succinimidyl ester was purchased from Molecular Probes, Eugene, OR. NAP-5 columns (Sephadex G-25 Medium, DNA grade) were purchased from Pharmacia Biotech. Nanopure H<sub>2</sub>O (>18.0 MΩ), purified using a Barnstead NANOpure ultrapure water system, was used for all experiments. An Eppendorf 5415C or a Beckman Avanti 30 centrifuge was used for centrifugation of Au nanoparticle solutions. High Performance Liquid Chromatography (HPLC) was performed using a HP series 1100 HPLC.

B. Physical Measurements.

Electronic absorption spectra of the oligonucleotide and nanoparticle solutions were recorded using a Hewlett-Packard (HP) 8452a diode array spectrophotometer. Fluorescence spectroscopy was performed using a Perkin-Elmer LS50 fluorimeter. Transmission Electron Microscopy (TEM) was performed with a Hitachi 8100 Transmission Electron Microscope operating at 200 kV. A Thermo Jarrell Ash AtomScan 25 atomic emission spectrometer with an inductively coupled plasma (ICP) source was used to determine the atomic concentration of gold in the nanoparticle

solutions (gold emission was monitored at 242.795 nm).

C. Synthesis and Purification of Fluorescein-Labeled  
Alkanethiol-Modified Oligonucleotides

Thiol-modified oligonucleotide strands containing either 12 or 32 bases, with 5'  
5 hexylthiol and 3' fluorescein moieties, were prepared. The sequence of the 12mer (S12F)  
was HS(CH<sub>2</sub>)<sub>6</sub>-5'-CGC-ATT-CAG-GAT-3'-(CH<sub>2</sub>)<sub>6</sub>-F [SEQ ID NO:50], and the 32mer  
(SA<sub>20</sub>12F) contained the same 12mer sequence with the addition of a 20 dA spacer  
sequence to the 5' end [SEQ ID NO:51]. The thiol-modified oligonucleotides were  
prepared as described in Storhoff et al., *J. Am. Chem.Soc.* **120**:1959-1964 (1998). An  
10 amino-modifier C7 CPG solid support was used in automated synthesis, and the 5'  
terminus was manually modified with hexylthiol phosphoramidite, as described  
previously. The 3' amino, 5' trityl-protected thiol modified oligonucleotides were purified  
by reverse-phase HPLC using an HP ODS Hypersil column (5 mm, 250 x 4 mm) with  
0.03 M triethyl ammonium acetate (TEAA), pH 7 and a 1% / minute gradient of 95%  
15 CH<sub>3</sub>CN / 5% 0.03 M TEAA at a flow rate of 1 mL/min., while monitoring the UV signal  
of DNA at 254 nm. The retention times of the 5'-S-trityl, 3' amino modified 12-base and  
32-base oligonucleotides were 36 and 32 minutes respectively.

The lyophilized product was redispersed in 1 ml of 0.1 M Na<sub>2</sub>CO<sub>3</sub> and, while  
stirring in the dark, 100 μL of 10 mg/ml succinimidyl ester of fluorescein (5,6 FAM-SE,  
20 Molecular Probes) in dry DMF was added over 1.5 hours according to the directions of  
the manufacturer (Molecular Probes literature). The solution was stirred at room  
temperature for an additional 15 hours, then precipitated from 100% ethanol at -20 °C.  
The precipitate was collected by centrifugation, dissolved in H<sub>2</sub>O and the coupled  
product separated from unreacted amino-terminated oligonucleotide by ion-exchange  
25 HPLC. A Dionex Nucleopac PA-100 column (250 x 4 mm) was operated with 10 mM  
NaOH aqueous eluent and a 1% / minute gradient of 1 M NaCl/10mM NaOH at a flow  
rate of 0.8 mL/minute. Retention times of 5'-S-trityl, 3' fluorescein modified 12mer and  
32mer were 50 and 49 minutes respectively. The oligonucleotide product was desalted

by reverse-phase HPLC. Removal of the trityl protection group of the fluorescein-terminated, trityl oligonucleotide was performed using silver nitrate and dithiothreitol (DTT) as previously described (Storhoff et al., *J. Am. Chem.Soc.* 120:1959-1964 (1998)). The yield and purity of the oligonucleotides were assessed using the techniques  
5 previously described for alkylthiol oligonucleotides (Storhoff et al., *J. Am. Chem.Soc.* 120:1959-1964 (1998)). Oligonucleotides were used immediately after detritylation of the thiol group.

Thiol-modified oligonucleotides containing 32 bases, with 3' propylthiol and 5' fluorescein moieties (HS(CH<sub>2</sub>)<sub>3</sub>-3'-(W)<sub>20</sub>-TAG-GAC-TTA-CGC-5'-(CH<sub>2</sub>)<sub>6</sub>-F, W= A or T)  
10 [SEQ ID NO:52] were synthesized on an automated synthesizer using 3' thiol modifier CPG. The 5' terminus of each oligonucleotide was coupled manually to fluorescein phosphoramidite (6-FAM, Glen Research). The modified oligonucleotides were purified by ion exchange HPLC (1% / min gradient of 1 M NaCl, 10 mM NaOH; retention time (Rt) ~ 48 min (W = T), Rt ~ 29 min (W = A)). After purification, the oligonucleotide  
15 solutions were desalted by reverse phase HPLC. The 3' thiol moieties were deprotected with dithiothreitol by a procedure previously described (Storhoff et al., *J. Am. Chem.Soc.* 120:1959-1964 (1998)).

#### D. Synthesis and Purification of Fluorescein Labeled Oligonucleotides.

The fluorophore labeled complement (12'F) consisted of 12 bases 3'-GCG-TAA-  
20 GTC-CTA-5'-(CH<sub>2</sub>)<sub>6</sub>-F [SEQ ID NO:53] complementary to the 12mer sequence in S12F and SA<sub>20</sub>12F. The oligonucleotide was synthesized using standard methods, and a syringe-based procedure, similar to the procedure reported above for the 5' alkylthiol modification, was used to couple fluorescein phosphoramidite (6-FAM, Glen Research) to the 5' end of the CPG-bound oligonucleotide. Purification was performed using  
25 reverse-phase HPLC as above. The fluorescein-labeled oligonucleotide had a retention time of 18 min. The fluorophore labeled complement, 3'12F (5'-ATC-CTG-AAT-GCG-F; [SEQ ID NO:54]) was prepared using an amino-modifier C7 CPG solid support for automated synthesis, followed by coupling of 5-(6)-carboxyfluorescein succinimidyl

ester to the 3' amine using the procedure described above.

#### E. Preparation and Characterization of Gold Nanoparticles

Gold nanoparticles were prepared by citrate reduction of  $\text{HAuCl}_4$  as described in Example 1. Transmission Electron Microscopy (TEM) performed with a Hitachi 8100  
5 TEM was used to determine the size distribution of the resulting nanoparticles. At least 250 particles were sized from TEM negatives using graphics software (ImageTool). The average diameter of a typical particle preparation was  $15.7 \pm 1.2$  nm. Assuming spherical nanoparticles and density equivalent to that of bulk gold ( $19.30 \text{ g/cm}^3$ ), an average molecular weight per particle was calculated ( $2.4 \times 10^7 \text{ g/mol}$ ). The atomic gold  
10 concentration in a solution of gold nanoparticles was determined by ICP-AES (inductively coupled plasmon atomic emission spectroscopy). A gold atomic absorption standard solution (Aldrich) was used for calibration. Comparison of atomic gold concentration in the particle solution to the average particle volume obtained by TEM analysis yielded the molar concentration of gold particles in a given preparation, typically  
15  $\sim 10$  nM. By measuring the UV-vis absorbance of nanoparticle solutions at the surface plasmon frequency (520 nm), the molar extinction coefficients ( $\epsilon$  at 520 nm) were calculated for the particles, typically  $4.2 \times 10^8 \text{ M}^{-1} \text{ cm}^{-1}$  for  $15.7 \pm 1.2$  nm diameter particles.

#### F. Preparation of Gold Thin Films.

20 Silicon wafers were cut into  $\sim 10$  mm x 6 mm pieces and cleaned with piranha etch solution (4:1 concentrated  $\text{H}_2\text{SO}_4$ : 30%  $\text{H}_2\text{O}_2$ ) for 30 min at  $50^\circ \text{C}$ , then rinsed with copious amounts of water, followed by ethanol. (*Warning: piranha etch solution reacts violently with organic materials and should be handled with extreme caution.*) Metal was deposited at a rate of 0.2 nm/s using an Edwards Auto 306 evaporator (base pressure of 3  
25  $\times 10^{-7}$  millibar) equipped with an Edwards FTM6 quartz crystal microbalance. The oxidized sides of the silicon were coated with a Ti adhesion layer of 5 nm, followed by 200 nm of gold.

#### G. Preparation of 5' Alkylthiol Oligonucleotide-Modified Gold Nanoparticles.

Gold nanoparticles were modified with fluorescein-alkylthiol oligonucleotides by adding freshly deprotected oligonucleotides to aqueous nanoparticle solution (particle concentration ~10 nM) to a final oligonucleotide concentration of 3  $\mu$ M. After 24 hours, the solution was buffered at pH 7 (0.01 M phosphate), and NaCl solution was added (to final concentration of 0.1 M). The solution was allowed to 'age' under these conditions for an additional 40 hours. Excess reagents were then removed by centrifugation for 30 minutes at 14,000 rpm. Following removal of the supernatant, the red oily precipitate was washed twice with 0.3 M NaCl, 10 mM phosphate buffer, pH 7, solution (PBS) by successive centrifugation and redispersion, then finally redispersed in fresh buffer solution. Invariably, a small amount (~ 10% as determined by UV-vis spectroscopy) of nanoparticle is discarded with the supernatant during the washing procedure. Therefore, final nanoparticle concentrations were determined by TEM, ICP-AES, and UV-vis spectroscopy (see above). Extinction coefficients and particle size distributions did not change significantly as a result of the oligonucleotide modification.

#### 15        H. Preparation of 5' Alkylthiol Oligonucleotide-Modified Gold Thin Films.

Silicon supported gold thin films were immersed in deposition solutions of deprotected alkylthiol modified oligonucleotides for equal times and buffer conditions as for the gold nanoparticles. Following oligonucleotide deposition, the films were rinsed extensively with 0.3 M PBS and stored in buffer solution. Gold was evaporated on one side only, leaving an unpassivated silicon/silicon oxide face. However, alkylthiol modified DNA did not adsorb appreciably to bare silicon oxide surfaces that were rinsed with PBS.

#### I. Quantitation of Alkylthiol-Oligonucleotides Loaded on Nanoparticles.

25        Mercaptoethanol (ME) was added (final concentration 12 mM) to fluorophore-labeled oligonucleotide modified nanoparticles or thin films in 0.3 M PBS, to displace the oligonucleotides. After 18 hours at room temperature with intermittent shaking, the solutions containing displaced oligonucleotides were separated from the gold by either centrifugation of the gold nanoparticles, or by removal of the gold thin film. Aliquots of

the supernatant were diluted two-fold by addition of 0.3 M PBS, pH 7. Care was taken to keep the pH and ionic strength of the sample and calibration standard solutions the same for all measurements due to the sensitivity of the optical properties of fluorescein to these conditions (Zhao et al., *Spectrochimica Acta* 45A:1113-1116 (1989)). The fluorescence maxima (measured at 520 nm) were converted to molar concentrations of the fluorescein-alkylthiol modified oligonucleotide by interpolation from a standard linear calibration curve. Standard curves were prepared with known concentrations of fluorophore-labeled oligonucleotides using identical buffer and salt concentrations. Finally, the average number of oligonucleotides per particle was obtained by dividing the measured oligonucleotide molar concentration by the original Au nanoparticle concentration. Normalized surface coverage values were then calculated by dividing by the estimated particle surface area (assuming spherical particles) in the nanoparticle solution. The assumption of roundness is based on a calculated average roundness factor of 0.93. Roundness factor is computed as:  $(4 \times \pi \times \text{Area}) / (\text{perimeter} \times 2)$  taken from Baxes, Gregory, *Digital Image Processing*, p. 157 (1994).

#### J. Quantitation of the Hybridized Target Surface Density.

To determine the activity of attached oligonucleotides for hybridization, fluorophore-labeled oligonucleotides, which were complementary to the surface-bound oligonucleotides (12'F), were reacted with oligonucleotide modified surfaces (gold nanoparticles or thin films) under hybridization conditions (3  $\mu$ M complementary oligonucleotide, 0.3 M PBS, pH 7, 24 hr). Non-hybridized oligonucleotides were removed from the gold by rinsing twice with buffered saline as described above. Then, the fluorophore-labeled oligonucleotides were dehybridized by addition of NaOH (final concentration  $\sim$  50 mM, pH 11-12, 4 hr). Following separation of the solution containing the 12'F from the nanoparticle solutions by centrifugation, and neutralization of the solutions by addition of 1 M HCl, the concentrations of hybridized oligonucleotide and corresponding hybridized target surface density were determined by fluorescence spectroscopy.



### K. Quantitation of Surface Coverage and Hybridization

Citrate stabilized gold nanoparticles were functionalized with 12mer fluorescein-modified alkylthiol DNA (HS-(CH<sub>2</sub>)<sub>6</sub>-5'-CGC-ATT-CAG-GAT-(CH<sub>2</sub>)<sub>4</sub>-F [SEQ ID NO:50]). Surface coverage studies were then performed by thoroughly rinsing away  
5 non-chemisorbed oligonucleotides, followed by removal of the fluorophore-labeled oligonucleotides from the gold surface, and quantitation of oligonucleotide concentration using fluorescence spectroscopy (as described above).

Removal of all the oligonucleotides from the gold surface and subsequent removal of gold nanoparticles from the solution is critical for obtaining accurate coverage  
10 data by fluorescence for several reasons. First, the fluorescence signal of labeled, surface bound DNA is efficiently quenched as a result of fluorescence resonance energy transfer (FRET) to the gold nanoparticle. Indeed, there is almost no measurable signal for fluorescein-modified oligonucleotides (12-32 nucleotide strands, sequences are given  
15 above) after they are immobilized on  $15.7 \pm 1.2$  nm gold nanoparticles and residual oligonucleotide in solution is washed away. Second, the gold nanoparticles absorb a significant amount of light between 200 nm and 530 nm, so their presence in solution during fluorescence measurements acts as a filter and diminishes the available excitation energy, as well as the intensity of emitted radiation. The gold surface plasmon band at 520 nm falls at the emission maximum of fluorescein.

20 Mercaptoethanol (ME) was used to rapidly displace the surface bound oligonucleotides by an exchange reaction. To examine the displacement kinetics, oligonucleotide-modified nanoparticles were exposed to ME (12 mM) for increasing periods of time prior to centrifugation and fluorescence measurements. The intensity of fluorescence associated with the solution free of nanoparticles can be used to determine  
25 how much oligonucleotide was released from the nanoparticles. The amount of oligonucleotide freed in exchange with ME increased until about 10 hours of exposure (Figure 29), which is indicative of complete oligonucleotide displacement. The displacement reaction was rapid, which is presumably due to the inability of the

oligonucleotide film to block access of the ME to the gold surface (Biebuyck et al., *Langmuir* 9:1766 (1993)).

The average oligonucleotide surface coverage of alkylthiol-modified 12mer oligonucleotide (S12F) on gold nanoparticles was  $34 \pm 1$  pmol/cm<sup>2</sup> (average of ten  
5 independent measurements of the sample.) For  $15.7 \pm 1.2$  nm diameter particles, this corresponds to roughly 159 thiol-bound 12mer strands per gold particle. Despite slight particle diameter variation from batch to batch, the area-normalized surface coverages were similar for different nanoparticle preparations.

In order to verify that this method is useful for obtaining accurate oligonucleotide  
10 surface coverages, it was used to displace fluorophore-labeled oligonucleotides from gold thin films, and the surface coverage data was compared with experiments aimed at getting similar information but with different techniques. In these experiments, gold thin films were subjected to a similar oligonucleotide modification and ME displacement procedure as the citrate stabilized gold nanoparticles (see above). The oligonucleotide  
15 displacement versus time curves for the gold thin films are very similar to those measured for gold nanoparticles. This suggests a similar rate of displacement for the thin films, even though the typical surface coverage values measured for these films were somewhat lower than the oligonucleotide coverages on gold nanoparticles. Importantly, the oligonucleotide surface coverages on gold thin films measured by our technique ( $18 \pm 3$   
20 pmol/cm<sup>2</sup>) fall within the range of previously reported coverages on oligonucleotide thin films ( $10$  pmol/cm<sup>2</sup> for a 25 base oligonucleotide on gold electrodes determined using electrochemistry or surface plasmon resonance spectroscopy (SPRS) (Steel et al., *Anal. Chem.* 70:4670-4677 (1998)). Differences in surface coverages are expected due to different oligonucleotide sequences and lengths, as well as film preparation methods.

25 The extent of hybridization of complementary fluorophore-labeled oligonucleotides (12F') to nanoparticles with surface-bound 12mer oligonucleotides was measured as described above. Briefly, S12F modified nanoparticles were exposed to 12F' at a concentration of 3  $\mu$ M for 24 hours under hybridization conditions (0.3 M PBS,

pH 7) and then rinsed extensively with buffer solution. Again, it was necessary to remove the hybridized strands from the gold before measuring fluorescence. This was accomplished by denaturing the duplex DNA in a high pH solution (NaOH, pH 11) followed by centrifugation. Hybridized 12F amounted to  $1.3 \pm 0.2$  pmol/cm<sup>2</sup> (approximately 6 duplexes per 15.7 nm particle; the average number of duplexes per particle was computed by multiplying the normalized hybridized surface coverage in pmol/cm<sup>2</sup> by the average particle surface area as found from size distributions measured by TEM.). In order to measure the extent of non-specific adsorption, S12F modified gold nanoparticles were exposed to fluorophore-labeled non-complementary 12 base oligonucleotides (12F') in 0.3 M PBS. After extensive rinsing (successive centrifugation/redispersion steps) and subsequent high pH treatment, the coverage of non-specifically adsorbed oligonucleotides on the nanoparticles was determined to be on the order of 0.1 pmol/cm<sup>2</sup>. An analogous procedure was used to measure hybridization to S12F modified gold thin films in order to compare the hybridization results to reported values on gold electrodes. The degree of hybridization,  $6 \pm 2$  pmol/cm<sup>2</sup>, was consistent with hybridization reported for mixed base 25mer on an gold electrode ( $2-6$  pmol/cm<sup>2</sup>) (Steel et al., *Anal. Chem.* 70:4670-4677 (1998)).

Surface coverages and hybridization values of the S12F/12F' system for both nanoparticles and thin films are summarized in Table 7. The most striking result is the low hybridization efficiency (~ 4 % of surface-bound strands on nanoparticles while 33 % of strands on thin films hybridize). Previous studies have shown similarly low hybridization for sufficiently densely packed oligonucleotide monolayers. This may reflect a low accessibility to incoming hybridizing strands, due to a combination of steric crowding of the bases, especially those near the gold surface, as well as electrostatic repulsive interactions.

#### L. Effect of Oligonucleotide Spacer on Surface Coverage and Hybridization.

Although the high coverage of the S12F oligonucleotide is advantageous in terms of nanoparticle stabilization, the low hybridization efficiency prompted us to devise a

means of decreasing steric congestion around the hybridizing sequence.

Oligonucleotides (32mer) were synthesized having a 20 dA spacer sequence inserted between the alkylthiol group and the original 12 base recognition sequence. This strategy was chosen based on the assumption that: 1) bases near the nanoparticle surface are sterically inaccessible because of weak interactions between the nitrogenous bases and the gold surface, as well as interstrand steric crowding, and 2) on a 15.7 nm diameter roughly spherical particle, 12mer sequences attached to the end of 20mer spacer units roughly perpendicular to the surface (Levicky et al., *J. Am. Chem. Soc.* **120**:9787-9792 (1998)) will lead to a film with a greater free volume as compared with a film formed from the same 12mer directly bound to the surface.

While the surface density of single-stranded SA<sub>20</sub>12F strands ( $15 \pm 4$  pmol/cm<sup>2</sup>) was lower than that of S12F ( $34 \pm 1$  pmol/cm<sup>2</sup>), the particles modified with a 32-mer using the identical surface modification showed comparable stability compared to those modified with 12-mer. As anticipated, the hybridization efficiency of the SA<sub>20</sub>12F/12F' system ( $6.6 \pm 0.2$  pmol/cm<sup>2</sup>, 44%) was increased to approximately 10 times that of the original S12F/12F' system, Table 7.

#### M. Effect of Electrolyte Concentration During Oligonucleotide Attachment

In working with the S12F sequence a salt aging step was found to be crucial in obtaining stable oligonucleotide modified nanoparticles (see Example 3). The gold nanoparticles modified with S12F in pure water fused together irreversibly to form a black precipitate upon centrifugation, while those aged in salt resisted aggregation when centrifuged, even in high ionic strength solutions. It is proposed that the increased stability is due to higher oligonucleotide surface coverages which leads to greater steric and electrostatic protection. Using the SA<sub>20</sub>12F modified particles, the effect of electrolyte conditions on oligonucleotide surface loading was investigated. As shown in Table 8, final surface coverages for gold nanoparticles which were exposed to oligonucleotides in water for 48 hours are much lower ( $7.9 \pm 0.2$  pmol/cm<sup>2</sup>) compared to those that were 'aged' in salt, or prepared by increasing the salt concentration gradually

over the course of the final 24 hours of the experiment (see above).

It is important to note that gold nanoparticles as synthesized irreversibly agglomerate even in very low ionic strength media. Indeed, they are naturally incompatible with salts and especially polyanions such as oligonucleotides. This aging treatment is essential for preparing stable oligonucleotide particles. Therefore, the particles must be initially modified with alkylthiol oligonucleotides in water prior to gradually increasing the ionic strength. It is likely that oligonucleotides initially lie flat, bound through weak interactions of the nitrogenous bases with gold. A similar mode of interaction has been proposed for oligonucleotides on thin films (Herne et al., *J. Am. Chem. Soc.* 119:8916-8920 (1997)). However, the interaction between oligonucleotides and the positively charged nanoparticle surface (Weitz et al., *Surf. Sci.* 158:147-164 (1985)) is expected to be even stronger. In the aging step, the high ionic strength medium effectively screens charge repulsion between neighboring oligonucleotides, as well as, attraction between the polyanionic oligonucleotide and the positively charged gold surface. This allows more oligonucleotides to bind to the nanoparticle surface, thereby increasing oligonucleotide surface coverage.

#### N. Effect of Oligonucleotide Spacer Sequence on Surface Coverage.

In order to examine how the sequence of the spacer affects oligonucleotide coverage on Au nanoparticles, fluorescein-modified 32-mer strands, with 20 dA and 20 dT spacers inserted between a 3' propylthiol and the fluorescein-labeled 12-mer sequence, were prepared. The most notable result of surface coverage and hybridization studies of nanoparticles modified with S3'T<sub>20</sub>12F and S3'A<sub>20</sub>12F is the greater surface coverage achieved with the 20 dT spacer ( $35 \pm 1$  pmol/cm<sup>2</sup>), in comparison to the 20 dA spacer ( $24 \pm 1$  pmol/cm<sup>2</sup>). The number of hybridized strands was comparable, although the percentage of surface bound strands which hybridized was lower for ST<sub>20</sub>12mer nanoparticles (79 %) than the SA<sub>20</sub>12 nanoparticles (~94%). These results suggest that dT rich oligonucleotide strands interact non-specifically with the nanoparticle surface to a lesser degree than dA rich oligonucleotide strands. Consequently, 20dT spacer segments

may extend perpendicular from the gold surface, promoting higher surface coverages, while 20dA spacer segments block gold sites by lying flat on the particle surface.

O. Effect of Coadsorbed Diluent Oligonucleotides

In addition to efficient hybridization, another important property of  
5 oligonucleotide modified nanoparticles is the possibility of adjusting the total number of hybridization events. This is most readily accomplished by adjusting the surface density of recognition strands. Other researchers have used coadsorbed diluent alkylthiols such as mercaptohexanol with modified oligonucleotides on gold electrodes to control hybridization (Steel et al., *Anal. Chem.* 70:4670-4677 (1998); Herne et al., *J. Am. Chem.*  
10 *Soc.* 119:8916-8920 (1997)). However, the inherent low stability of unprotected gold nanoparticles poses serious constraints on the choice of diluent molecule. A thiol modified 20 dA sequence (SA<sub>20</sub>) [SEQ ID NO:55] proved to be suitable in terms of maintaining particle stability in the high ionic strength buffers which are needed for hybridization and protecting the surface from non-specific adsorption.

15 Nanoparticles were modified using solutions containing different recognition strand (SA<sub>20</sub>12F) to diluent (SA<sub>20</sub>) strand molar ratios. The resulting particles were analyzed by the fluorescence method described above to determine the SA<sub>20</sub>12F surface density, and then tested for hybridization efficiency with 12F.

The SA<sub>20</sub>12F surface density increased linearly with respect to the proportion of  
20 SA<sub>20</sub>12F to SA<sub>20</sub> in the deposition solution, Figure 30. This is an interesting result because it suggests that the ratio of SA<sub>20</sub>12F to SA<sub>20</sub> attached to the nanoparticles reflects that of the solution. This result is in contrast to what is normally seen for mixtures of short chain alkyl or T-functionalized thiols, where solubility and chain length play a crucial role in adsorption kinetics (Bain et al., *J. Am. Chem. Soc.* 111:7155-7164 (1989);  
25 Bain et al., *J. Am. Chem. Soc.* 111:7164-7175 (1989)).

The amount of complementary 12F' oligonucleotide which hybridized to each different sample also increased linearly with increasing SA<sub>20</sub>12F surface coverage, Figure 31. The fact that this relationship is well defined indicates that it is possible to predict

and control the extent of hybridization of the nanoparticle-oligonucleotide conjugates. This suggests that hybridization of 12F' becomes more difficult at higher SA<sub>20</sub>12F coverages, which is most likely a result of steric crowding and electrostatic repulsion between oligonucleotides.

5           P. Summary.

This study has shown that it is important to achieve a balance between oligonucleotide coverage high enough to stabilize the nanoparticles to which they are attached, yet low enough so that a high percentage of the strands are accessible for hybridization with oligonucleotides in solution. This has been achieved by adjusting salt  
10 conditions during oligonucleotide attachment to the nanoparticles to gain high oligonucleotide surface coverages, oligonucleotide spacer segments to reduce electrosteric interactions, and coadsorbed diluent strands to reproducibly control the average number of hybridization events for each nanoparticle. It has also been shown  
15 that the nature of the tether (spacer) sequence influences the number of oligonucleotide strands loaded onto gold nanoparticles. This work has important implications regarding understanding interactions between oligonucleotides and nanoparticles, as well as optimizing the sensitivity of nanoparticle-oligonucleotide detection methods.

TABLE 7

5 Single strand surface coverage and corresponding hybridized surface coverages for gold thin films and gold nanoparticles. Comparison between S12F and SA<sub>20</sub>12F surface coverage and hybridization. Thiol modified oligonucleotides were attached to the gold from 3 μM aqueous solutions and aged in 0.1 M NaCl. All hybridization studies were performed in 0.3 M PBS, pH 7.

Oligonucleotide Pair	Surface Coverage (pmol/cm <sup>2</sup> )	Hybridization Coverage (pmol/cm <sup>2</sup> )	% Hybridization Efficiency
Au nanoparticles			
S12F/12F'	34 ± 1	1.3 ± 0.2	- 4%
SA <sub>20</sub> 12F/12F'	15 ± 4	6.6 ± 0.2	- 44%
Au thin films			
S12F/12F'	18 ± 3	6 ± 2	- 33%

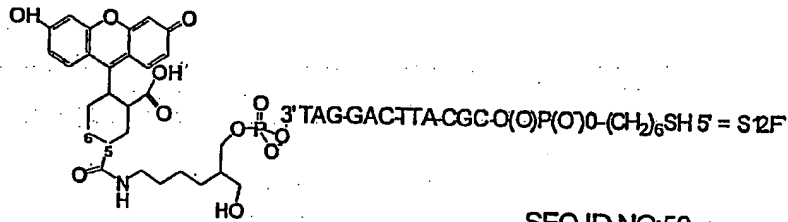

SEQ ID NO:50

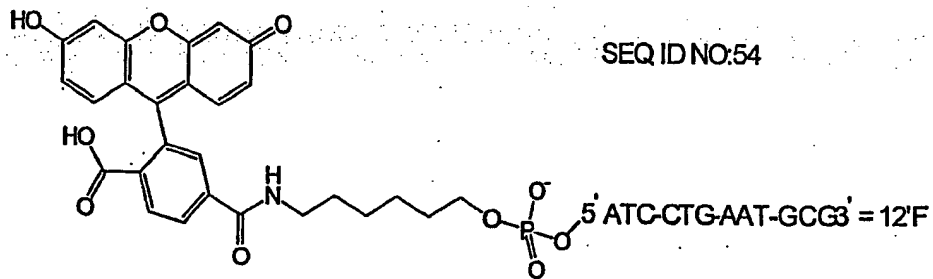

SEQ ID NO:54



TABLE 8

- 5 Effect of salt aging on surface coverage of SA<sub>20</sub>12F oligonucleotides to gold nanoparticles and hybridization to 12F'. All hybridization experiments were performed in 0.3 M PBS, pH 7.

Buffer conditions during adsorption of alkylthiol DNA	Surface Coverage (pmol/cm <sup>2</sup> )	Hybridization Coverage (pmol/cm <sup>2</sup> )	Hybridization Efficiency (%)
H <sub>2</sub> O	7.9 ± 0.2	— <sup>a</sup>	—
0.1 M NaCl, 10 mM phosphate	15 ± 4	6.6 ± 0.2	~44
1.0 M NaCl, 10 mM phosphate	20 ± 2	6.5 ± 0.2	~33

- 10 <sup>a</sup> Reliable values for these experiments could not be obtained due to a small amount of particle aggregation which occurred after centrifugation.

TABLE 9

- 15 Effect of oligonucleotide spacer sequence on surface coverage and hybridization efficiency.

Oligonucleotide Pair	Surface Coverage (pmol/cm <sup>2</sup> )	Hybridization Coverage (pmol/cm <sup>2</sup> )	Hybridization Efficiency (%)
S3'A <sub>20</sub> 12F / 3'12F	24 ± 1	9 ± 2	~38
S3'T <sub>20</sub> 12F / 3'12F	35 ± 1	12 ± 1	~34

20 S3'A<sub>20</sub>12F / S3'T<sub>20</sub>12F = HS(CH<sub>2</sub>)<sub>3</sub>-3'-W<sub>20</sub>-TAG-GAC-TTA-CGC-5'-(CH<sub>2</sub>)<sub>6</sub>-F [SEQ ID NO:52]  
3'12F = 5'-ATC-CTG-AAT-GCG-F [SEQ ID NO:54]

Example 19: Gene Chip Assay

- 25 An ultrasensitive and ultrasensitive method for analyzing combinatorial DNA arrays using oligonucleotide-functionalized gold nanoparticles is described in this example. An unusually narrow temperature range for thermal dissociation of nanoparticle-target complexes permits the discrimination of a given oligonucleotide sequence from targets with single nucleotide mismatches with extraordinary selectivity. In addition, when coupled with signal amplification method based on nanoparticle-catalyzed reduction of silver(I), the sensitivity of this nanoparticle array detection system

exceeds that of the analogous, conventional fluorophore system by two orders of magnitude.

Sequence-selective DNA detection has become increasingly important as scientists unravel the genetic basis of disease and use this new information to improve medical diagnosis and treatment. Commonly used heterogeneous DNA sequence detection systems, such as Southern blots and combinatorial DNA chips, rely on the specific hybridization of surface-bound, single-strand capture oligonucleotides complementary to target DNAs. Both the specificity and sensitivity of these assays are dependent upon the dissociation properties of capture strands hybridized to perfectly-matched and mismatched targets. As described below, it has surprisingly been discovered that a single type of nanoparticles hybridized to a substrate exhibits a melting profile that is substantially sharper than both the analogous fluorophore-based system and unlabeled DNA. Moreover, the melting temperature for the nanoparticle duplex is 11 degrees higher than for the analogous fluorophore system with identical sequences. These two observations, combined with the development of a quantitative signal amplification method based upon nanoparticle catalyzed reduction of silver(I), have allowed the development of a new chip-based detection system for DNA that has single-base mismatch selectivity and a sensitivity that is two orders of magnitude more sensitive than the conventional analogous fluorescence-based assays.

Gold nanoparticles (13 nm diameter) having oligonucleotide attached to them prepared as described in Example 3 were used to indicate the presence of a particular DNA sequence hybridized to a transparent substrate in a three-component sandwich assay format (see Figure 32). In a typical experiment, a substrate was fabricated by functionalizing a float glass microscope slide (Fisher Scientific) with amine-modified probe oligonucleotides as described in Example 10. This method was used to generate slides functionalized with a single type of oligonucleotides over their entire surface or in arrays of multiple types of oligonucleotides spotted with a commercial microarrayer. Nanoparticles having indicator oligonucleotides attached to them and synthetic 30-mer

oligonucleotide targets (based on the anthrax protective antigen sequence) were then cohybridized to these substrates (see Figure 32). Therefore, the presence of nanoparticles at the surface indicated the detection of a particular 30-base sequence. At high target concentrations ( $\geq 1$  nM), the high density of hybridized nanoparticles on the surface made the surface appear light pink (see Figure 33). At lower target concentrations, attached nanoparticles could not be visualized with the naked eye (although they could be imaged by field-emission scanning electron microscopy). In order to facilitate the visualization of nanoparticles hybridized to the substrate surface, a signal amplification method in which silver ions are catalytically reduced by hydroquinone to form silver metal on the slide surface was employed. Although this method has been used for enlargement of protein- and antibody-conjugated gold nanoparticles in histochemical microscopy studies (Hacker, in *Colloidal Gold: Principles, Methods, and Applications*, M. A. Hayat, Ed. (Academic Press, San Diego, 1989), vol. 1, chap. 10; Zehbe et al., *Am. J. Pathol.* **150**, 1553 (1997)) its use in quantitative DNA hybridization assays is novel (Tomlinson et al., *Anal. Biochem.*, **171**:217 (1988)). Not only did this method allow very low surface coverages of nanoparticle probes to be visualized by a simple flatbed scanner or the naked eye (Figure 33), it also permitted quantification of target hybridization based on the optical density of the stained area (Figure 34). Significantly, in the absence of the target, or in the presence of noncomplementary target, no staining of the surface was observed, demonstrating that neither nonspecific binding of nanoparticles to the surface, nor nonspecific silver staining, occurs. This result is an extraordinary feature of these nanoparticle-oligonucleotide conjugates which enables ultra-sensitive and -selective detection of nucleic acids.

It has been determined that the unique hybridization properties of oligonucleotide-functionalized nanoparticles of the present invention can be further used to improve the selectivity of combinatorial oligonucleotide arrays (or "gene chips") (Fodor, *Science* **277**, 393 (1997)). The relative ratio of target hybridized to different elements of an oligonucleotide array will determine the accuracy of the array in determining the target

sequence; this ratio is dependent upon the hybridization properties of the duplex formed between different capture strands and the DNA target. Remarkably, these hybridization properties are dramatically improved by the use of nanoparticle labels instead of fluorophore labels. As shown in Figure 35, the dehybridization of nanoparticle-labeled targets from surface-bound capture strands was much more sensitive to temperature than that of fluorophore-labeled targets with identical sequences. While the fluorophore-labeled targets dehybridized from surface capture strands over a very broad temperature range (first derivative FWHM = 16 °C), identical nanoparticle-labeled targets melted much more sharply (first derivative FWHM = 3 °C). It was anticipated that these sharpened dissociation profiles would improve the stringency of chip-based sequence analysis, which is usually effected by a post-hybridization stringency wash. Indeed, the ratio of target hybridized to complementary surface probes to that hybridized to mismatched probes after a stringency wash at a specific temperature (represented by the vertical lines in Figure 35) is much higher with nanoparticle labels than fluorophore labels. This should translate to higher selectivity in chip detection formats. In addition, nanoparticle labels should increase array sensitivity by raising the melting temperature ( $T_m$ ) of surface duplexes, which lowers the critical concentration below which duplexes spontaneously melt at room temperature.

In order to evaluate the effectiveness of nanoparticles as colorimetric indicators for oligonucleotide arrays, test chips were probed with a synthetic target and labeled with both fluorophore and nanoparticle indicators. The test arrays and oligonucleotide target were fabricated according to published protocols (Guo et al., *Nucl. Acids Res.*, 22:5456 (1994); arrays of 175  $\mu\text{m}$  diameter spots separated by 375  $\mu\text{m}$  were patterned using a Genetic Microsystems 417 Microarrayer). Arrays contained four elements corresponding to the each of the four possible nucleotides (N) at position 8 of the target (see Figure 32). The synthetic target and either fluorescent-labeled or nanoparticle-labeled probes were hybridized stepwise to arrays in hybridization buffer, and each step was followed with a stringency buffer wash at 35 °C. First, 20  $\mu\text{L}$  of a 1 nM solution of synthetic target in 2

X PBS (0.3 M NaCl, 10 mM NaH<sub>2</sub>PO<sub>4</sub>/Na<sub>2</sub>HPO<sub>4</sub> buffer, pH 7) was hybridized to the array for 4 hours at room temperature in a hybridization chamber (Grace Bio-Labs Cover Well PC20), and then washed at 35°C with clean 2 X PBS buffer. Next, 20 µL of a 100 pM solution of oligonucleotide-functionalized gold nanoparticles in 2 X PBS was  
5 hybridized to the array for 4 hours at room temperature in a fresh hybridization chamber. The array was washed at 35°C with clean 2 X PBS, then twice with 2 X PBN (0.3 M NaNO<sub>3</sub>, 10 mM NaH<sub>2</sub>PO<sub>4</sub>/Na<sub>2</sub>HPO<sub>4</sub> buffer, pH 7). Then, the nanoparticle arrays were immersed in a silver amplification solution (Sigma Chemical, Silver Enhancer Solution) for 5 min and washed with water. Silver amplification darkened the array elements  
10 considerably, and 200 µm diameter elements could be easily imaged with a flatbed scanner or even the naked eye.

Arrays challenged with the model target and nanoparticle-labeled probes and stained with the silver solution clearly exhibited highly selective hybridization to complementary array elements (Figure 36A). Redundant spots of the same capture  
15 sequence showed reproducible and consistent hybridization signal. No background adsorption by nanoparticles or silver stain was observed; the image greyscale value reported by the flatbed scanner is the same as that observed for a clear microscope slide. The darker spots corresponding to adenine at position 8 (N=A) indicate that oligonucleotide target hybridized preferentially to perfectly complementary capture  
20 strands over mismatched ones, by a greater than 3:1 ratio. In addition, integrated greyscale values for each set of spots follows the predicted stability of the Watson-Crick base pairs, A:T > G:T > C:T > T:T (Allawi et al., *Biochemistry* 36, 10581, (1988)). Normally, G:T mismatches are particularly difficult to discriminate from A:T  
25 complements (Saiki et al., in *Mutation Detection*, Cotton et al., eds. (Oxford University Press, Oxford, 1998), chap. 7; S. Ikuta et al., *Nucl. Acids Res.* 15, 797 (1987)), and the distinction of these two array elements demonstrates the remarkable resolving power of nanoparticle labels in single nucleotide mismatch detection. The selectivity of the nanoparticle-based arrays was higher than that of the fluorophore-indicated arrays, Figure

36B; fluorophore labels provided only 2:1 selectivity for adenine at position 8.

The assays utilizing nanoparticle-labeled probes were significantly more sensitive than those utilizing fluorophore-labeled probes. Hybridization signal could be resolved at the N=A elements at target concentrations as low as 50 fM (or, for a hybridization chamber containing 20  $\mu$ L of solution,  $1 \times 10^6$  total copies); this represents a dramatic increase in sensitivity over common Cy3/Cy5 fluorophore-labeled arrays, for which approx. 1 pM or greater target concentrations are typically required. The higher melting temperatures observed for nanoparticle-target complexes immobilized on surfaces undoubtedly contribute to array sensitivity. The greater stability of the probe/target/surface-oligonucleotide complex in the case of the nanoparticle system as compared with the fluorophore system presumably results in less target and probe lost during washing steps.

Colorimetric, nanoparticle labeling of combinatorial oligonucleotide arrays will be useful in applications such as single nucleotide polymorphism analysis, where single mismatch resolution, sensitivity, cost and ease of use are important factors. Moreover, the sensitivity of this system, which has yet to be totally optimized, points toward a potential method for detecting oligonucleotide targets without the need for target amplification schemes such as polymerase chain reaction.

#### 20 Example 20: Nanoparticle Structures

The reversible assembly of supramolecular layered gold nanoparticle structures onto glass supports, mediated by hybridized DNA linkers, is described. Layers of oligonucleotide-functionalized nanoparticles were successively attached to oligonucleotide-functionalized glass substrates in the presence of a complementary DNA linker. The unique recognition properties of DNA allow the nanoparticle structures to be assembled selectively in the presence of the complementary linker. In addition, the structures can be assembled and disassembled in response to external stimuli which mediate hybridization of the linking duplex DNA, including solution temperature, pH,

and ionic strength. In addition to offering a very selective and controlled way of building nanoparticle based architectures on a solid support, this system allows one to study the factors that influence both the optical and melting properties of nanoparticle network structures linked with DNA.

5 Others have demonstrated how bifunctional organic molecules (Gittins et al., *Adv. Mater.* **11**:737 (1999); Brust et al., *Langmuir* **14**:5425 (1998); Bright et al., *Langmuir* **14**:5695 (1998); Grabar et al., *J. Am. Chem. Soc.* **118**:1148 (1996); Freeman et al., *Science* **267**:1629 (1995); Schmid et al., *Angew. Chem. Int. Ed. Engl.* **39**:181 (2000); Marinakos et al., *Chem. Mater.* **10**:1214 (1998)) or polyelectrolytes (Storhoff et al., *J.*  
10 *Am. Chem. Soc.* **120**:1959 (1998); Storhoff et al., *J. Cluster Sci.* **8**:179 (1997); Elghanian et al., *Science* **277**:1078 (1997); Mirkin et al., *Nature* **382**:607 (1996)) can be used to controllably construct mono- and multilayered nanoparticle materials off of planar substrates. The attractive feature of using DNA as a nanoparticle interconnect is that one can synthetically program interparticle distances, particle periodicities, and particle  
15 compositions through choice of DNA sequence. Moreover, one can utilize the reversible binding properties of oligonucleotides to ensure the formation of thermodynamic rather than kinetic structures. In addition to providing a new and powerful method for controlling the growth of nanoparticle-based architectures from solid substrates, this strategy also allows one to evaluate the relationship between nanoparticle aggregate size  
20 and both melting and optical properties of aggregate DNA-interlinked structures. An understanding of these two physical parameters and their relationship to materials architecture is essential for utilizing nanoparticle network materials, especially in the area of biodetection.

The oligonucleotide-functionalized, 13-nm-diameter gold nanoparticles used to  
25 construct the multilayer assemblies were prepared as described in Examples 1 and 3. The nanoparticles had 5'-hexanethiol-capped oligonucleotide 1 (5'-HS(CH<sub>2</sub>)<sub>6</sub>O(PO<sub>2</sub>)<sup>-</sup>O-CGCATTCAGGAT-3' [SEQ ID NO:50]) and 3'-propanethiol-capped oligonucleotide 2 (3'-HS(CH<sub>2</sub>)<sub>3</sub>O(PO<sub>2</sub>)<sup>-</sup>O-ATGCTCAACTCT-5' [SEQ ID NO:59]) attached to them to

yield nanoparticles *a* and *b*, respectively (see Figure 37). Glass slides were functionalized with 12-mer oligonucleotide **2** as described in Example 10. To build nanoparticle layers, the substrates were first immersed in a 10 nM solution of 24-mer linker **3** (5'-TACGAGTTGAGAATCCTGAATGCG-3' [SEQ ID NO:60]) and allowed to hybridize with it for 4 hours at room temperature (see Figure 37). The substrates were washed with clean buffer solution, and then hybridized with a 2 nM solution of particle *a* for 4 hours at room temperature to attach the first nanoparticle layer. A second nanoparticle layer could be attached to the first one by similarly exposing the surface to solutions of linker **3** and nanoparticle *b*. These hybridization steps could be repeated to attach multiple, alternating layers of nanoparticles *a* and *b*, each layer connected to the previous one by linker **3**. In the absence of linker, or in the presence of noncomplementary oligonucleotide, no hybridization of nanoparticles to the surface was observed. In addition, multilayer assembly was only observed under conditions which promoted the hybridization of the DNA linkers: neutral pH, moderate salt concentration (> 0.05 M NaCl), and a temperature below the duplex melting temperature ( $T_m$ ).

Each hybridized nanoparticle layer imparted a deeper red color to the substrate, and after ten hybridized layers, the supporting glass slide appeared reflective and gold in color. Transmission UV-vis spectroscopy of the substrate was used to monitor the successive hybridization of nanoparticle layers to the surface, Figure 38A. The low absorbance of the initial nanoparticle layer suggests that it seeded the formation of further layers, which showed a near linear increase in the intensity of the plasmon band with each additional layer (for each successive nanoparticle layer formation, no additional absorbance was observed on exposure for longer times or to higher concentrations of either linker **3** or nanoparticle solution). The linearity of the absorbance increase after the generation of the initial nanoparticle layer indicates that the surface was saturated with hybridized nanoparticles with each successive application, Figure 38B. This is supported by field-emission scanning electron microscope (FE-SEM) images of one (Figure 39A) and two (Figure 39B) nanoparticle layers on a surface, which show low nanoparticle



coverage with one layer, but near complete coverage with two layers. The  $\lambda_{\max}$  of the plasmon band for the multilayer assemblies shifts no more than 10 nm, even after 5 layers. The *direction* of this shift is consistent with other experimental (Grabar et al., *J. Am. Chem. Soc.* **118**:1148 (1996)) and theoretical (Quinten et al., *Surf. Sci.* **172**:557 (1986); Yang et al., *J. Chem. Phys.* **103**:869 (1995)) treatments of gold nanoparticle aggregates. However, the *magnitude* of the shift is small compared to that previously observed for suspensions of oligonucleotide-linked gold nanoparticle networks, which show  $\lambda_{\max} > 570$  nm (see previous examples). This suggests that many more linked nanoparticles --- perhaps hundreds or thousands --- are required to produce the dramatic color change from red to blue observed for gold nanoparticle-based oligonucleotide probes. (Storhoff et al., *J. Am. Chem. Soc.* **120**:1959 (1998); Storhoff et al., *J. Cluster Sci.* **8**:179 (1997); Elghanian et al., *Science* **277**:1078 (1997); Mirkin et al., *Nature* **382**:607 (1996).). Surface plasmon shifts for aggregated gold nanoparticles have been shown to be highly dependent on interparticle distance (Quinten et al., *Surf. Sci.* **172**:557 (1986); Storhoff et al., *J. Am. Chem. Soc.*, in press), and the large distances provided by oligonucleotide linkers (8.2 nm for this system)) significantly reduce the progressive effect of nanoparticle aggregation on the gold surface plasmon band.

The dissociation properties of the assembled nanoparticle multilayers were highly dependent upon the number of layers. When the multilayer-coated substrates were suspended in buffer solution and the temperature raised above the  $T_m$  of the linking oligonucleotides (53°C), the nanoparticles dissociated into solution, leaving behind a colorless glass surface. Increasing or decreasing the pH (>11 or <3) or decreasing the salt concentration of the buffer suspension (below ~0.01 M NaCl) also dissociated the nanoparticles by dehybridizing the linking DNA. The multilayer assembly was fully reversible, and nanoparticles could be hybridized to, and dehybridized from, the glass substrates (*e.g.* three cycles were demonstrated with no detectable irreversible nanoparticle binding).

Significantly, while all of the surface bound nanoparticle assemblies dissociated

above the  $T_m$  of the linking oligonucleotides, the sharpness of these transitions depended on the size of the supported aggregate, Figure 39D-F. Surprisingly, the dissociation of the first nanoparticle layer from the substrate exhibited a transition (Figure 39D, FWHM of the first derivative = 5 °C) that was sharper than that of the same oligonucleotides without nanoparticles in solution, Figure 39C. As more nanoparticle layers were hybridized to the substrate, the melting transition of the oligonucleotide-linked nanoparticles became successively sharper (Figure 39E-F, FWHM of the first derivative = 3 °C), until it matched that of the large nanoparticle network assemblies found in solution. (Gittins et al., *Adv. Mater.* 11:737 (1999); Brust et al., *Langmuir* 14:5425 (1998)). These experiments confirm that more than two nanoparticles and multiple DNA interconnects are required to obtain the optimally sharp melting curves. They also show that the optical changes in this system are completely decoupled from the melting properties (*i.e.*, small aggregates can give sharp transitions but still not change color).

15 **Example 21: Electrical Properties of Gold Nanoparticle Assemblies**

Electron transport through DNA has been one of the most intensely debated subjects in chemistry over the past five years. (Kelley et al., *Science* 283:375-381 (1999); Turro et al., *JBIC* 3:201-209 (1998); Lewis et al., *JBIC* 3:215-221 (1998); Ratner, M. *Nature* 397:480-481 (1999); Okahata et al., *J. Am. Chem. Soc.* 120:6165-6166 (1998))

20 Some claim that DNA is able to efficiently transport electrons, while others believe it to be an insulator.

In a seemingly disparate field of study, a great deal of effort has been devoted to examining the electrical properties of nanoparticle-based materials. (Terrill et al., *J. Am. Chem. Soc.* 117:12537-12548 (1995); Brust et al., *Adv. Mater.* 7:795-797 (1995); Bethell et al., *J. Electroanal. Chem.* 409:137-143 (1996); Musick et al., *Chem. Mater.* 9:1499-1501 (1997); Brust et al., *Langmuir* 14:5425-5429 (1998); Collier et al., *Science* 277:1978-1981 (1997)). Indeed, many groups have explored ways to assemble nanoparticles into two- and three-dimensional networks and have investigated the

electronic properties of such structures. However, virtually nothing is known about the electrical properties of nanoparticle-based materials linked with DNA.

For the first time, in this study, the electrical properties of gold nanoparticle assemblies, formed with different length DNA interconnects have been examined. As shown below, these hybrid inorganic assemblies behave as semiconductors, regardless of oligonucleotide particle interconnect length over a 24 to 72 nucleotide range. The results reported herein indicate that DNA interconnects can be used as chemically specific scaffolding materials for metallic nanoparticles without forming insulating barriers between them and thereby destroying their electrical properties. These results point towards new ways such hybrid assemblies can be exploited as electronic materials.

At the heart of this issue is the following question: Can nanoparticles assembled by DNA still conduct electricity or will the DNA interconnects, which are heavily loaded on each particle, (Mucic, R. C. *Synthetically Programmable Nanoparticle Assembly Using DNA*, Thesis Ph. D., Northwestern University (1999)) act as insulating shells? The conductivities of these materials as a function of temperature, oligonucleotide length, and relative humidity were examined. The DNA-linked nanoparticle structures were characterized by field emission scanning electron microscopy (FE-SEM), synchrotron small angle x-ray scattering (SAXS) experiments, thermal denaturation profiles, and UV-vis spectroscopy.

In a typical experiment (see Figure 40), citrate-stabilized 13 nm gold nanoparticles were modified with 3' and 5' alkanethiol-capped 12-mer oligonucleotides 1 (3' SH (CH<sub>2</sub>)<sub>3</sub>O(PO<sup>2-</sup>)O-ATGCTCAACTCT 5' [SEQ ID NO:59]) and 2 (5' SH (CH<sub>2</sub>)<sub>6</sub>O(PO<sup>2-</sup>)O-CGCATTCAGGAT 3' [SEQ ID NO:50]) as described in Examples 1 and 3. DNA strands with lengths of 24, 48, or 72 bases (3 (5'TACGAGTTGAGAATCCTGAATGCG3' [SEQ ID NO:60]), 4 (5'TACGAGTTGAGACCGTTAAGACGAGGCAATC-ATGCAATCCTGAATGCG 3'[SEQ ID NO:61]), and 5 (5'TACGAGTTGAGACCGTTAAGACGAGGCAATCATGCATATATTGGACGCTTT

ACGGACAACATCCTGAATGCG3'[SEQ ID NO:62]) were used as linkers. Fillers 6 (3'GGCAATTCTGCTCCGTTAGTACGT5'[SEQ ID NO:63]) and 7 (3'GGCAATTCTGCTCCGTTAGTACGTATATAACCTGCGAAATGCCTGTTG5'[SEQ ID NO:64]) were used with the 48 and 72 base linkers. The DNA-modified nanoparticles and DNA linkers and fillers were stored in 0.3 M NaCl, 10 mM phosphate (pH 7) buffer (referred as to 0.3 M PBS) prior to use. To construct nanoparticle assemblies, 1-modified gold nanoparticles (652  $\mu$ l, 9.7 nM) and 2-modified gold nanoparticles (652  $\mu$ l, 9.7 nM) were added to linker DNA 3, 4, or 5 (30  $\mu$ l, 10 nM). After full precipitation, the aggregates were washed with 0.3 M CH<sub>3</sub>COONH<sub>4</sub> solution to remove excess linker DNA and NaCl.

Lyophilization ( $10^{-3}$  ~  $10^{-2}$  torr) of the aggregate to dryness results in pellets and removal of the volatile salt, CH<sub>3</sub>COONH<sub>4</sub>. Unfunctionalized, citrate-stabilized particles, prepared by the Frens method, (Frens, *Nature Phys. Sci.* 241:20-22 (1973)) were dried as a film and used for comparison purposes. The resulting dried aggregates had a color resembling tarnished brass and were very brittle. FE-SEM images demonstrated that oligonucleotide-modified nanoparticles remained intact upon drying, while citrate-stabilized nanoparticles fused to one another. Significantly, the dried DNA-linked aggregates could be redispersed in 0.3 M PBS buffer (1ml), and exhibited excellent melting properties; heating such a dispersion to 60 °C resulted in dehybridization of the DNA interconnects, yielding a red solution of dispersed nanoparticles. This combined with the FE-SEM data conclusively demonstrated that DNA-modified gold nanoparticles are not irreversibly aggregated upon drying.

The electrical conductivities of the three samples (dried aggregates linked by 3, 4, and 5, respectively) were measured using a computer-controlled, four-probe technique. Electrical contacts consisted of fine gold wires (25 and 60  $\mu$ m diameter) attached to pellets with gold paste. Samples were cooled in a moderate vacuum ( $10^{-3}$  to  $10^{-2}$  torr), and conductivity was measured as the temperature was increased under a dry, low pressure of helium gas. The sample chamber was insulated from light in order to

eliminate possible optoelectronic effects. Excitation currents were kept at or below 100 nA, and the voltage across the entire sample was limited to a maximum of 20 V. Surprisingly, the conductivities of the aggregates formed from all three linkers, ranged from  $10^{-5}$  to  $10^{-4}$  S/cm at room temperature, and they showed similar temperature dependent behavior. The conductivities of the DNA-linked aggregates showed Arrhenius behavior up to about 190°K, which is characteristic of a semiconducting material. This is similar to the behavior of activated electron hopping observed in discontinuous metal island films (Barwinski, *Thin Solid Films* 128:1-9 (1985)). Gold nanoparticle networks linked by alkanedithiols have shown similar temperature dependence (Brust et al., *Adv. Mater.* 7:795-797 (1995); Bethell et al., *J. Electroanal. Chem.* 409:137-143 (1996)). Activation energies of charge transport can be obtained from a plot of  $\ln \sigma$  versus  $1/T$  using equation (1).

$$\sigma = \sigma_0 \exp[-E_a/(kT)] \quad (1)$$

The average activation energies calculated from three measurements were  $7.4 \pm 0.2$  meV,  $7.5 \pm 0.3$  meV, and  $7.6 \pm 0.4$  meV for the 24-, 48-, and 72-mer linkers, respectively. Conductivity data from 50°K to 150°K were used for these calculations.

Since the electrical properties of these types of materials should depend on the distance between particles, synchrotron SAXS experiments were used to determine interparticle distances of the dispersed and dried aggregates. The SAXS experiments were performed at the Dupont-Northwestern-Dow Collaborative Access Team (DND-CAT) Sector 5 of the Advanced Photon Source, Argonne National Laboratory. DNA-linked aggregates and dilute samples of DNA-modified colloid were irradiated with an 0.3 micron beam of 1.54 Å radiation, and scattered radiation was collected on a CCD detector. The 2D data were circularly averaged and transformed into a function,  $I(s)$ , of the scattering vector magnitude,  $s = 2\sin(\Theta)/\lambda$ , where  $2\Theta$  is the scattering angle and  $\lambda$  is the wavelength of the incident radiation. All data were corrected for background

scattering and sample absorption. The first peak position, which is sensitive to interparticle distance, drastically changed from  $s$  values of  $0.063 \text{ nm}^{-1}$ ,  $0.048 \text{ nm}^{-1}$ , and  $0.037 \text{ nm}^{-1}$  for the 24-, 48-, and 72-mer linked aggregates, respectively, to an  $s$  value of  $0.087 \text{ nm}^{-1}$  upon drying for all three aggregates structures. This indicates that interparticle distances decreased significantly upon drying, to the point where the particles were almost touching, and that such distances were virtually independent of linker length, while those in solution were highly dependent on linker length. This explains why similar activation energies were observed for the three different linker systems in the dried pellet conductivity experiments. Moreover, it also explains why relatively high conductivities were observed, regardless of how one views the electronic properties of DNA. Unlike the DNA-linked materials, the dried film of citrate-stabilized gold nanoparticles showed metallic behavior. This is consistent with the SEM data, which showed that such particles fuse together.

Above  $190^\circ\text{K}$ , the measured conductivities of the DNA-linked samples showed an anomalous dipping behavior. For all samples, the conductivity started to decrease abruptly at approximately  $190^\circ\text{K}$  and continued to decrease until approximately  $250^\circ\text{K}$ , at which point it increased again. To investigate this unusual behavior in detail, the electrical conductivity was measured as the sample was cooled and warmed repeatedly. Interestingly, the dip in conductivity only occurred in the direction of increasing temperature. Since DNA is hydrophilic and water could potentially affect the electrical properties of the hybrid structures, the effect of relative humidity on the conductivity of the gold aggregates was examined. The resistance increased by a factor of 10 with increasing humidity from 1% to 100%. It should be noted that the characteristic dip was very weak when the sample was kept in vacuum ( $10^{-6}$  Torr) for 48 hours prior to the conductivity measurement. From these observations, it was concluded that the unusual dip and subsequent rise in conductivity above  $190^\circ\text{K}$  is associated with water melting and the hygroscopic nature of the DNA, which temporarily increased the interparticle distance (until evaporation took place). Consistent with this hypothesis, SAXS

measurements on a dried aggregate that was wetted with 0.3 M PBS buffer showed a 200% increase in interparticle distance (~2 nm).

These studies are important for the following reasons. First, they show that one can use the molecular recognition properties of DNA to assemble nanoparticle-based materials without passivating them or destroying their discrete structural or electrical properties. If these DNA-functionalized particles are to be used to study electrical transport in three-dimensional macroscopic assemblies or even lithographically patterned structures (Piner et al., *Science* 283:661-663 (1999)), it is imperative that their electrical transport properties be delineated. Second, it shows that over a fairly long linker distance (8 ~ 24 nm), the conductivities of the dried assemblies are virtually independent of DNA linker length. This is likely a result of the removal of water and the use of a volatile salt in these experiments; indeed, the free volume created by removal of solvent and salt allows the DNA to be compressed on the surface and close approach of the particles within the aggregates. Third, the aggregates with the DNA-protected nanoparticles behave as semiconductors, while films formed from citrate-stabilized particles exhibit irreversible particle fusion and metallic behavior. Finally, these results point toward the use of these materials in DNA diagnostic applications where sequence specific binding events between nanoparticles functionalized with oligonucleotides and target DNA effect the closing of a circuit and a dramatic increase in conductivity (*i.e.* from an insulator to a semiconductor) (see next example).

#### Example 22: Detection Of Nucleic Acid Using Gold Electrodes

A method of detecting nucleic acid using gold electrodes is illustrated diagrammatically in Figure 41. A glass surface between two gold electrodes was modified with 12-mer oligonucleotides 1 (3' NH<sub>2</sub>(CH<sub>2</sub>)<sub>7</sub>O(PO<sup>2-</sup>)O-ATG-CTC-AAC-TCT [SEQ ID NO:59]) complementary to target DNA 3 (5' TAC GAG TTG AGA ATC CTG AAT GCG [SEQ ID NO:60]) by the method of Guo *et al.*, *Nucleic Acids Res.*, 22, 5456-5465 (1994). Oligonucleotides 2 (5' SH(CH<sub>2</sub>)<sub>6</sub>O(PO<sup>2-</sup>)O-CGC-ATT-CAG-GAT [SEQ ID NO:50]) were

prepared and attached to 13 nm gold nanoparticles as described in Examples 1 and 18 to yield nanoparticles a. Target DNA 3 and nanoparticles a were added to the device. The color of the glass surface turned pink, indicating that target DNA-gold nanoparticle assemblies were formed on the glass substrate. Next, the device was immersed in 0.3 M NaCl, 10 mM phosphate buffer and heated at 40 °C for 1 hour to remove nonspecifically bound DNA, and then treated with a silver staining solution as described in Example 19 for 5 minutes. The resistance of the electrode was 67 kΩ.

For comparison, a control device modified by attaching oligonucleotides 4, instead of oligonucleotides 1, between the electrodes. Oligonucleotides 4 have the same sequence (5' NH<sub>2</sub>(CH<sub>2</sub>)<sub>6</sub>O(PO<sup>2-</sup>)O-CGC-ATT-CAG-GAT [SEQ ID NO:50]) as oligonucleotides 2 on the nanoparticles and will bind to target DNA 3 so as to prevent binding of the nanoparticles. The test was otherwise performed as described above. The resistance was higher than 40 MΩ, the detection limit of the multimeter that was used.

This experiment shows that only complementary target DNA strands form nanoparticle assemblies between the two electrodes of the device, and that the circuit can be completed by nanoparticle hybridization and subsequent silver staining. Therefore, complementary DNA and noncomplementary DNA can be differentiated by measuring conductivity. This format is extendable to substrate arrays (chips) with thousands of pairs of electrodes capable of testing for thousands of different nucleic acids simultaneously.

**Example 23: Preparation of Oligonucleotide-Modified Gold Nanoparticles using cyclic disulfide linkers**

In this Example, we describe a new cyclic disulfide linker for binding oligonucleotides to gold surfaces, based on steroid disulfide 1a (Figure 42) that is simple to prepare, is broadly useful, and affords gold-oligonucleotide conjugates exhibiting greater stability toward DTT than those prepared using mercaptohexyl linkers. A cyclic disulfide was selected as the reactive site of the anchor unit since ester derivatives of 1,2-



dithiane-4,5-diol were known to form monolayers on gold surfaces (Nuzzo, et al., J. Am. Chem. Soc. 105,4481-4483) and a cyclic disulfide would plausibly bind to the surface through both sulfur atoms (Ulman, A., MRS Bulletin, June 46-51) to give a chelate structure that could exhibit enhanced stability. Epiandrosterone was selected as a linking  
5 element since it is a readily available, easily derivatized ketoalcohol and, as a substituent with a large hydrophobic surface, might be expected to help screen the approach of water soluble molecules to the gold surface (Letsinger, et al., J. Am. Chem. Soc. 115, 7535-7536 – Bioconjugate Chem. 9, 826-830).

The oligonucleotide-gold probes used in previous studies were prepared by the  
10 reaction of oligonucleotides being terminal mercaptohexyl groups with gold nanoparticles in an aqueous buffer. They proved to be surprisingly robust, functioning well even after heating to 100°C or after storing for 3 years at 5 °C. We have found, however, that these conjugates lose activity as hybridization probes when soaked in solutions containing thiols, which act by displacing the derivatized oligonucleotides from  
15 the gold surface. This feature poses a problem when the nanoparticle probes are to be used in a solution containing a thiol, as for example, a PCR solution that contains dithiothreitol (DTT) as a stabilizer for the polymerase enzyme.

(a) General

NMR spectra were recorded on 500 MHz (<sup>1</sup>H) and 400 MHz (<sup>31</sup>P; acquisition at  
20 161.9 MHz) Varian spectrometers using CDCl<sub>3</sub> as a solvent and TMS as an internal (<sup>1</sup>H) and H<sub>3</sub>PO<sub>4</sub> as an external (<sup>31</sup>P) standard; chemical shifts are expressed in δ units. MS data were obtained on a Quattro II triple quadrupole mass spectrometer. Automated oligonucleotide synthesis was carried out on a milligene Expedite DNA synthesizer. The analysis for S was made by Oneida Research Services.

25 (b) Preparation of Steroid-Disulfide Ketal (1a)

The synthetic scheme is shown in Figure 43. A solution of epiandrosterone (0.5g), 1,2-dithiane-4,5-diol (0.28 g), and p-toluenesulfonic acid (15 mg) in toluene (30 mL) was refluxed for 7 h under conditions for removal of water (Dean Stark apparatus);

then the toluene was removed under reduced pressure and the residue taken up in ethyl acetate. This solution was washed with water, dried over sodium sulfate, and concentrated to a syrupy residue, which on standing overnight in pentane/ether afforded compound 1a as a white solid (400 mg); Rf (TLC, silica plate, ether as eluent) 0.5; for comparison, Rf values for epiandrosterone and 1,2-dithiane-4,5-diol obtained under the same conditions are 0.4, and 0.3, respectively. Recrystallization from pentane/ether afforded a white powder, mp 110-112 °C; <sup>1</sup>H NMR, δ 3.6 (1H, C<sup>3</sup>OH), 3.54-3.39 (2H, m 2OCH of the dithiane ring), 3.2-3.0 (4H, m 2CH<sub>2</sub>S), 2.1-0.7 (29H, m steroid H); mass spectrum (ES<sup>+</sup>) calcd for C<sub>23</sub>H<sub>36</sub>O<sub>3</sub>S<sub>2</sub> (M+H) 425.2179, found 425.2151. Anal. (C<sub>23</sub>H<sub>37</sub>O<sub>3</sub>S<sub>2</sub>)S: calcd, 15.12; found, 15.26.

(c) Preparation of Steroid-Disulfide Ketal Phosphoramidite Derivative (1b)

Compound 1a (100 mg) was dissolved in THF (3 mL) and cooled in a dry ice alcohol bath. N,N-diisopropylethylamine (80 μL) and β-cyanoethyl chlorodiisopropylphosphoramidite (80 μL) were added successively; then the mixture was warmed to room temperature, stirred for 2 h, mixed with ethyl acetate (100 mL), washed with 5% aq. NaHCO<sub>3</sub> and with water, dried over sodium sulfate, and concentrated to dryness. The residue was taken up in the minimum amount of dichloromethane, precipitated at -70 °C by addition of hexane, and dried under vacuum; yield 100 mg; <sup>31</sup>P NMR 146.02.

(d) Preparation of 5'-Modified Oligonucleotides and Nanoparticle Conjugates

5'-Modified oligonucleotides Ic1 and Ic2 were constructed on CPG supports using conventional phosphoramidite chemistry, except that compound 1b (Figure 42) was employed in the final phosphitilation step. Products were cleaved from the support by treatment with concentrated NH<sub>4</sub>OH for 16 h at 55 °C. The oligonucleotides were purified by reversed phase HPLC on a Dionex DX500 system equipped with a Hewlett Packard ODS Hypersil column (4.6 x 200 nm, 5 μm particle size) using TEAA buffer (pH 7.0) and a 1%/min gradient of 95% CH<sub>3</sub>CN/5% 0.03 TEAA at a flow rate of 1

mL/min. A nice feature of the hydrophobic steroid group is that the capped derivatives separate cleanly from uncapped oligomers. Sulfur derivatized oligonucleotides **IIa**, **IIc1** and **IIc2** (Figure 43) were prepared similarly using the commercially available "5'-Thiol-Modifier reagent" (C6 Glen Research) and cleavage of the trityl protecting group with  
5 silver nitrate as previously described (Storhoff, J.J., et al., J. Am. Chem. Soc. 120, 1959-1964). For preparation of disulfide **IIIc1**, "Thiol-Modifier C6 S-S" (Glen Research) was used in the final phosphitilation and the terminal dimethoxytrityl group was cleaved with aqueous 80% acetic acid.

Each of the modified oligonucleotides was immobilized on ~ 13 nm gold  
10 nanoparticles by the procedure used for anchoring oligonucleotides through a mercaptohexyl head group (Storhoff et al. (1998) J. Am. Chem. Soc. 120, 1959-1964). This involved soaking citrate stabilized nanoparticles (~ 13 nm in diameter) for 56 hours in a buffer-salt solution containing an oligonucleotide bearing a terminal sulfur  
15 substituent (HS- or acyclic or cyclic disulfide) followed by addition of NaCl to 0.1 M and 24h of standing. The nanoparticles were pelleted by centrifugation, the supernatant solution was removed, and the nanoparticles were washed, resuspended in buffer, recentrifuged, and then suspended in 0.1 M NaCl, 10 mM phosphate. This procedure  
afforded the nanoparticle oligonucleotide conjugates free from the excess sulfurized oligonucleotides employed in the loading process.

20 (e) Hybridization

To evaluate the utility of nanoparticle-oligonucleotide probes containing the disulfide-steroid anchor we prepared probes **Ic1**, **Ic2**, **IIc1**, **IIc2**, and **IIIc1** by  
immobilizing the modified oligonucleotides on gold nanoparticles (Figure 2). The oligomers in a given series have the same nucleotide sequence but differ in structure of  
25 the 5'-head group Y. Conjugates **Ic1** and **Ic2** have steroid-disulfide head groups; **IIc1**, **IIc2**, mercaptohexyl head groups; and **IIIc1**, acyclic disulfide head groups. The (dA)<sub>20</sub> chains serve as spacers between the gold and the oligonucleotide recognition regions to facilitate hybridization. Many of the sulfur derivatized oligomers bind to each

nanoparticle. Hybridization of pairs of nanoparticle probes with target oligonucleotides leads to formation of three dimensional networks and a change in color from red to blue-gray (Mucic, R. C., et al., *J. Am. Chem. Soc.* 120, 12674-12675).

Hybridization of the probes was examined using a 79-mer oligonucleotide  
5 targets, containing sequences complementary to the probes (Figure 43). The reactions were carried out at room temperature by adding 1  $\mu$ L of the target solution (10 pmol of IV) to colloidal solutions of the probe pairs Ic1, Ic2, and IIc1 and IIc2, and IIIc1 and IIc2 (50  $\mu$ L and 1.0 A<sub>520</sub> Unit of each nanoparticle probe) in 0.5 M NaCl, 10 mM phosphate (pH 7.0). At times 10 seconds, 5 minutes, and 10 minutes, aliquots (3  $\mu$ L) were removed  
10 and spotted on a C-18 reversed phase TLC plate. The various probe pairs all behaved the same: the spots for the 10 second reactions were red, indicative of free nanoparticles; those for the 10 minute reactions were deep blue-gray, characteristic of aggregates of nanoparticles; and the 5 minute reactions afforded spots with a reddish blue color, indicative of a mixture of non-associated and associated nanoparticles. In agreement  
15 with previous observations for aggregation of nanoparticles effected by hybridization of oligonucleotides (Storhoff, J. J., et al., *J. Am. Chem. Soc.* 120, 1959-1964; Elghanian, et al., *Science*, 277, 1078-1081; Mucic, R. C., et al., *J. Am. Chem. Soc.* 120, 12674-12675; Mitchell, G. P., *J. Am. Chem. Soc.* 121, 8122-8123), the reactions were reversible. Thus, warming the aggregate mixture to 90 °C (above the dissociation temperature for the  
20 oligomers linking the nanoparticles together) and spotting while hot afforded a red spot. For control experiments in which the oligonucleotide target was omitted or was not complementary to the probes, the color was red under all conditions.

We conclude that the nanoparticle conjugates generated via the steroid-disulfide anchor function effectively as hybridization probes. Moreover, as judged by the spot test,  
25 the conjugates with the various anchor units react with the target oligonucleotides at comparable rates. This feature is consistent with expectations for probes having comparable densities of oligonucleotides on the surface of the nanoparticles and nucleotide recognition regions relatively far removed from the 5'-head groups.

(f) Reaction of Nanoparticle Probes with Dithiothreitol.

Addition of thiols to colloidal solutions of gold nanoparticles or gold nanoparticles loaded with mercaptohexyl-oligonucleotides leads to aggregation of the nanoparticles. The color changes from red to deep blue, and on standing a dark precipitate settles out. As demonstrated with experiments with nanoparticles bearing fluorescently labeled oligonucleotides, the thiol displaces the mercaptoalkyl-oligonucleotides bound at the gold surface (Mucic, R. C., (1999) Synthetic Programmable Nanoparticle Assembly Using DNA, PhD Thesis, Northwestern University). In contrast to aggregation induced by hybridization of oligonucleotide-nanoparticle conjugates, these reactions are irreversible; neither heating nor addition of NaOH disassembles the aggregates.

We have used this color to monitor the reaction of DTT with probes prepared with the steroid cyclic disulfide, the mercaptohexyl, and the acyclic disulfide head groups. The experiments were carried out by adding 1  $\mu$ L of 1M DTT in water to 100  $\mu$ L of the nanoparticle-oligonucleotide probe solution (2  $A_{520}$  Units of nanoparticles) in 0.5 M NaCl and 10 mM phosphate (pH 7.0), then spotting 3  $\mu$ L aliquots on a TLC plate at various times and observing the color. As shown in Table 1, colloidal probes derived from oligonucleotides with the mercaptohexyl (**IIc1** and **IIc2**) and acyclic oligonucleotide headgroups (**IIIc1**) reacted rapidly. A red-blue spot was obtained in 20 seconds and a strong blue spot within 5 minutes. By 100 minutes, most of the gold had precipitated. In contrast, no color change was observed for the reaction of the probes prepared with the steroid-cyclic disulfide head group (**Ic1**, **Ic2**) within 40 minutes. It took 100 minutes to reach the same color obtained with probes prepared with **IIc1**, **IIc2**, or with **IIIc1** in 20 seconds. On this basis, we estimate that the rate of reaction of the steroid disulfide probes with DTT is of the order of  $1/300^{\text{th}}$  that of the other probes. The probe prepared from the acyclic disulfide anchor **3c** reacts at about the same rate as the probes prepared with the mercaptohexyl anchor. The latter result is not surprising in view of evidence that the reaction of an acyclic disulfide with gold probably involves cleavage of the S-S

bond (Zhong, C. J., Langmuir, 15, 518-525). Accordingly, an oligonucleotide with an acyclic head group would likely be linked to gold through a single sulfur atom, as in the case of mercaptohexyl-oligonucleotide derivatives.

To see if probes prepared from 1c1 and 1c2 in fact still serve as hybridization probes after standing in the presence of DTT, we treated two samples of mixtures of the probes with DTT under the conditions used for the reactions in Table I. After 30 minutes, 1  $\mu$ L of a solution of the 79-mer target oligonucleotide (10 pmol) was added to one. Both samples were frozen quickly, allowed to thaw, and assayed by the spot test. The spot for the sample containing the target was blue and that for the control lacking the target was red, demonstrating that these nanoparticle conjugates were not only stable but also effective as probes after exposure to DTT under conditions causing aggregation of probes derived from the mercaptohexyl or linear disulfide anchoring group.

Table 1. Colors from reactions of Gold Nanoparticle Probes with DTT

1c1 + 1c2	Time 0	20 sec	5 min	40 min	100 min
	red	red	red	red	red-blue
<b>IIc1 + IIc2</b>	red	red-blue	blue	blue	(black prec.)
<b>IIIc1</b>	red	red-blue	blue	blue	(black prec.)

(g) Conclusion

Gold nanoparticle-oligonucleotide conjugates made using this cyclic disulfide linker serve as effective probes for detecting specific oligonucleotide sequences, and they exhibit much greater stability toward dithiothreitol than corresponding conjugates prepared with the conventional mercaptohexyl group or an acyclic disulfide unit. The high stability toward thiol deactivation likely results, in part at least, from anchoring each

oligonucleotide to gold through two sulfur atoms.

Example 24: Preparation of Oligonucleotide-Modified Gold Nanoparticles using a simple cyclic disulfide linker.

5           In this Example, we prepared a non-steroid cyclic disulfide linker and oligonucleotide-nanoparticle probes from this linker and evaluated the probes stability in the presence of thiol-containing solutions relative to probes prepared with steroidal cyclic disulfide and alkyl thiol linkers. Procedures have been described for preparing probes for detecting DNA or RNA sequences by binding oligonucleotides to gold nanoparticles  
10 using alkylthiol anchor groups, I, Figure 44 [C. A. Mirkin et al., Nature, 382, 607 (1996); Storhoff, et al. J. Am. Chem. Soc., 120, 1959 (1998)] or a steroid cyclic disulfide anchor group, II, Figure 44 [R. L. Letsinger et al., Bioconjugate Chemistry, 11, 289 (2000)]. As probes, the conjugates prepared using the steroid cyclic disulfide linker have proved advantageous in that they are much more stable in the presence of thiol compounds, such  
15 as mercaptoethanol or dithiothreitol (DTT), than are conjugates prepared using an alkylthiol anchor. This feature is important since PCR solutions employed in amplifying DNA samples for detection contain small amounts of DTT to protect the enzyme. For simple and rapid detection of PCR products it is desirable to use probes with high stability toward DTT so that the test can be carried out directly in the PCR solution  
20 without having to first isolate the amplified DNA.

Two features distinguish the steroid cyclic anchor (compound 1, Figure 42): (1) the cyclic disulfide, which can in principle provide two binding sites that could act cooperatively in holding a given oligonucleotide at the gold surface, and (2) the steroid unit which could stabilize neighboring chains on the gold by hydrophobic interactions  
25 (see for example, R. L. Letsinger et al., J. Am. Chem. Soc. 115, 7535 (1993). To assess the importance of these contributions we have prepared and examined gold conjugates anchored by a cyclic disulfide lacking a steroid group, compound IIIc (Figure 44).

Compound 2a, prepared by heating trans-1,2-dithiane-4,5-dithiol with acetol in

toluene, was converted to a cyanoethyl N,N-di-i-propyl phosphoramidite reagent, 2b, which was employed in the final coupling step in the synthesis of modified oligonucleotides 2c1 and 2c2. One gold conjugate probe was prepared by treating a gold colloid solution with 2c1 and an equimolar amount of 2d, which serves a diluent on the gold surface. A companion probe was made from 2c2 and 2d in the same way. These nanoparticle conjugates were stable in a range of solutions of sodium chloride (0.1, 0.3, 0.5, 0.7 M), both on standing and on freezing and thawing.

(a) Preparation of compounds 2a, 2b, 2c1 and 2c2.

Compounds 2a was prepared as described in Example 23. Phosphitilation of 2a and synthesis of oligonucleotides 2c1 and 2c2 were carried out as described previously for the steroid cyclic disulfide derivatives in Example 23 and elsewhere [R. L. Letsinger et al., *Bioconjugate Chemistry*, 11, 289 (2000), the disclosure which is incorporated by reference in its entirety]. The time of reaction in the step involving condensation of IIIb with the oligomer on the CPG support was 10 min.

(b) Preparation of Gold-Oligonucleotide Conjugates.

Equimolar amount of oligonucleotides 2c1 and 2d or 2c2 and 2d were added to 13 nm gold colloids (~ 10 nM) to provide solutions containing 1.7  $\mu$ mole/mL of each oligonucleotide. The solutions were stored in the dark for 24 h; then salts were added to make the solutions 0.3 M in NaCl, 10 mM in phosphate (pH 7.0), and 0.01% in sodium azide. After 24 h the NaCl concentration was increased to 0.8 M and the solution were allowed to stand for another 24 h. The colloid was then filtered to remove any aggregates and the solution was centrifuged to collect the nanoparticles. The pellets were washed with nanopure water, recentrifuged and redispersed in 0.1 M NaCl, 10 mM phosphate buffer (pH 7.0), 0.01 % sodium azide.

(c) Reaction of nanoparticles probes with dithiothreitol

Displacement studies were carried out at room temperature (22°C) by adding 2  $\mu$ L of 0.1 M DTT to 20  $\mu$ L of a mixture of equal volumes of the colloidal conjugates obtained from 2c1 and 2c2. Aliquots (3  $\mu$ L) were periodically removed and spotted onto



a white Nylon membrane. Initially the spots were red. Displacement of the oligonucleotide sulfur derivatives from the gold by DTT led to mixtures that afforded a blue-gray spot in the spot test. The time for displacement by DTT was taken as the time for the mixture to give a strong blue-gray color in a spot test. For the mixture of  
5 conjugates derived from 2c1 and 2c2 this time was 10 hours.

For comparison, oligonucleotide conjugates were similarly prepared from oligonucleotide sequences c1 and c2 (Figure 44) using the mercaptohexyl anchor (compound 2, Figure 42) and the steroid cyclic disulfide anchor (compound 1, Figure 42). The reaction times for the conjugates prepared from the monothiol derivative (2, Figure  
10 42) and the steroid cyclic disulfide as measured by the time to afford a blue-gray spot, were 5 minutes and 53 hours, respectively. These values correspond to relative stabilities of 1, ~60, and ~300 for the nanoparticle oligonucleotide conjugates derived from the mercaptoalkyl derivatives, the non-steroid cyclic disulfide, and the steroid cyclic  
15 disulfide derivatives, respectively. The results show that the cyclic disulfide anchor unit itself is sufficient to afford high stability relative to the mercaptoalkyl group in these systems. The large hydrophobic group in nanoparticle conjugates derived from compound 1 also appears to play a role in enhancing stability toward thiol displacement of the oligonucleotides.

#### 20 Example 25: Preparation of Oligonucleotide-Modified Gold Nanoparticles

In this Example, we evaluated the stability of a new acyclic disulfide linker, a tri thiol, relative to alkyl thiol and steroidal cyclic disulfide linkers in the presence of thiol-containing solutions. For comparison, oligonucleotides with a mercaptohexyl anchor (compound 5, Figure 45) and with a steroid cyclic disulfide anchor (compound 6, Figure  
25 45) were prepared.

##### (a) Synthesis and characterization of 5'-tri-mercaptoalkyl oligonucleotide.

The 5'-trimercaptoalkylthiol oligonucleotide was synthesized as shown in Figure 47. Trembler phosphoramidite 7 (Glen Research Inc, Sterling, VA), Figure 45, and Thiol-

modifier C6 S-S phosphoramidite, were sequentially coupled to the 5' end of a protected oligomer still bound to the CPG support. The product was cleaved from the CPG and purified as describe above. The retention time for tri-thiol oligonucleotide with three DMT group on the end is approximately 64 minutes. 5'-DMT groups were subsequently removed by dissolving the oligonucleotide in 80% acetic acid for 30 min, followed by evaporation. The oligonucleotide was redissolved in 500  $\mu$ L nanopure water and the solution was extracted with ethyl acetate ( $3 \times 300 \mu$ L). After evaporation of the solvent, the oligonucleotide was obtained as a white solid. The retention time of this 5'- tri-disulfide oligonucleotide with no DMT group was around 35 minutes on reverse phase columns while 24 minutes on the ion-exchange column. These peaks were both more than 97% of the area in the spectra, which indicates the high purity of the oligonucleotide. The formula weight of oligonucleotide 8 (Figure 45) was obtained by electrospray MS (calculated: 12242.85, found 12244.1). The three disulfide groups on the DNA stand were reduced tri thiol groups as described above for 5' monothiol DNA; then the oligonucleotide was purified though a NAP-5 column.

(b) Preparation of 5'-thiol or disulfide DNA modified gold nanoparticle

Gold nanoparticles were used as purchased from Vector Laboratories (Burlingame, CA). To 10 mL of 30nm gold colloid was added 5 OD of thiol modified DNA. The solution was brought to 0.3 M NaCl/10 mM sodium phosphate buffer (pH 7) (PBS) gradually. Then the nanoparticles were thrown down by centrifugation. After removing the colorless supernatant, the red oily precipitate was redispersed in 10 mL of fresh PBS buffer. The colloid was washed twice more using 10ml fresh PBS buffer by repeating this process.

(c) Stability test of thiol-DNA modified gold nanoparticles

Solid DTT was added to 600 uL solutions of the different types of thiol- or disulfide DNA modified 30 nm gold nanoparticle colloids until the DTT concentration was 0.017M. As DTT displaces the oligonucleotides, the color of the colloid turns from red to blue. UV/VIS spectra were taken as a function of time. The absorbance at  $\sim 528$ nm

associated with dispersed 30nm gold particles began to decrease and a broad band at 700nm began to grow. The band at 700 nm is associated with colloid aggregation. As shown in Figure 48, single thiol oligonucleotide (1)-modified 30 nm gold particles quickly form an aggregate in 0.017M DTT; after 1.5 hours, the colloid totally turns blue.

- 5 The solution containing disulfide oligonucleotide (4)-modified nanoparticles turns blue after 20 hours under identical conditions. For the trithiol-oligonucleotide (cleaved 6) modified nanoparticles, it took 40 h to turn the solution blue.

10 Example 26: Detection of an analyte using a nanoparticle-nucleic acid-sfp member conjugate

This example demonstrates the detection of an analyte (biotin) using a nanoparticle-streptavidin probe (Figures 54 and 56).

(a) Preparation of nanoparticle-nucleic acid-protein conjugate

- 15 Nanoparticle-nucleic acid conjugates are prepared as described in Example 3. The oligonucleotide modifier used to prepare these conjugates have the following sequence: 5'SH(CH<sub>2</sub>)<sub>6</sub>-A<sub>10</sub>-CGCATTCAAGGAT 3' (2)(SEQ ID NO: 74). As shown in Figure 56, biotin labeled oligonucleotide (1) [3' biotin-TEG-A<sub>10</sub>-ATGCTCAACTCT 5'] (SEQ ID NO: 73) is prepared by literature procedure using a Biotin TEG CPG support (Glen Research, Sterling, Virginia; Catalog no. 20-2955-01). To make the streptavidin/DNA
- 20 conjugate, streptavidin was reacted with 1 equivalent of biotin-modified oligonucleotides in 20 mM Tris (pH 7.2), 0.2 mM EDTA buffer solution at room temperature for 2 h on a shaker. Streptavidin complexed to different numbers of oligonucleotides were separated by ion exchange HPLC with 20 mM Tris (pH 7.2) and a 0.5 %/min gradient of 20 mM Tris, 1 M NaCl at a flow rate of 1 mL/min, while monitoring the UV signal of DNA at
- 25 260 nm and 280 nm. The streptavidin/biotin-modified oligonucleotide mixture showed four peaks at 45 min, 56 min, 67 min and 71 min, which correspond to the 1:1, 2:1, 3:1, and 4:1 oligonucleotide-streptavidin complexes, respectively. The 1:1 complex of streptavidin/oligonucleotide (10 uM, 5uL) was isolated and premixed with linker DNA

[5'TACGAGTTGAGAATCCTGATTGCG3'] (3) (SEQ ID NO: 76) (10uM, 5uL) in 0.3 M PBS (0.3 M NaCl, 10 mM phosphate buffer, pH 7) and then the mixture was added to the nanoparticle-oligonucleotide conjugates (10 nM, 130 uL) in 0.3 M PBS to prepare a nanoparticle-oligonucleotide-streptavidin conjugate. The solution containing  
5 nanoparticle-oligonucleotide conjugates, streptavidin/oligonucleotide, and linker DNA was frozen in dry ice for 10 min and thawed to facilitate DNA hybridization. After 12 hr, the solution was centrifuged at 10000 rpm for 20 min and supernatant was removed. Red oily precipitate of nanoparticle-oligonucleotide-streptavidin conjugate was redispersed in 0.3 M PBS buffer.

10 The nanoparticle-oligonucleotide-streptavidin conjugate was then used to detect for the presence of a target analyte, biotin immobilized onto a glass surface.

(b) Detection of biotin

Biotin was immobilized to a glass slide according to the following procedure: Oligonucleotide modified glass slide was prepared by previously reported method  
15 (Science, 2000, 289, 1757-1760) and then the biotin modified oligonucleotide was hybridized to the surface DNA. (Biotin modified glass slide can be prepared by various method. One example is to prepare amine modified glass slide and then react the surface amine with various commercially available biotinylation reagents which react with amine.) As shown in Figure 54, the immobilized biotin glass slide was then treated with  
20 a medium containing the nanoparticle-oligonucleotide-streptavidin (2 nM in 0.3 M PBS). The presence of the captured probe was demonstrated, after washing and treating with silver enhancing solution [silver enhancer solution A (catalog no. S5020, Sigma Company, St. Louis, MO, USA) and silver enhancer solution B (catalog no. S 5145, Sigma Company), see also Science, 2000, 289, 1757], by the appearance of a gray or  
25 shiny silver spot. If desired, fluorescently labeled specific binding pair members linked to oligonucleotides can be used to prepare the nanoparticle-oligonucleotide-spf probe. This fluorophore labeled probe can then be used to detect for the presence of analyte.

Example 27: Specific binding comparison of gold colloid streptavidin conjugates

In this Example, nonspecific binding of the nanoparticle streptavidin probe prepared in accordance with Example 26 and a commercial Au colloid (20 nm)/ streptavidin conjugate (full name: streptavidin-gold labeled)(purchased from Sigma  
5 Company, St. Louis, MO, USA, Catalog No. S6514) were evaluated. 5 ul each of the commercial solution containing the conjugate and a solution containing the inventive probe (2 nM in 0.3 M PBS) were spotted on a glass slide. After 20 hr, the slide was washed with water and treated with silver enhancing solution [see Example 26]. The commercial conjugate showed a grey spot after 5 min of developing, indicating the  
10 presence of Au colloids on the glass surface, while the Example 3 nanoparticle streptavidin probe showed no visible silver stain (Figure 53). The signal difference could be enhanced by applying second DNA-modified nanoparticles to the silver stained slide and restaining it. This demonstrates that the nanoparticle-oligonucleotide-sbp conjugates of the invention are more resistant to nonspecific binding than the commercial Au  
15 colloid/streptavidin conjugate.

Example 28: Preparation of nanoparticle assembly

As discussed herein, specific binding pair members, e.g., receptors or ligands, can be functionalized with oligonucleotides and immobilized onto oligonucleotide-  
20 modified nanoparticles to generate a new class of hybrid particles that exhibit the high stability of the oligonucleotide modified particles but with molecular recognition properties that are dictated by the specific binding pair member rather than DNA. Alternatively, one could functionalize a protein that has multiple receptor binding sites with receptor-modified oligonucleotides so that the protein receptor complex could be  
25 used as one of the building blocks, in place of one of the inorganic nanoparticles, in our original materials assembly scheme. In this Example, we use 13 nm gold nanoparticles, streptavidin, and biotinylated DNA to prepare new nanoparticle assemblies (Figure 52) and study some of the physical and chemical properties of the resulting new bioinorganic

materials.

(a) Experimental.

The methods for preparing oligonucleotide-modified 13 nm Au particles (2-Au) and linker DNA (3) were reported elsewhere. The oligonucleotide modifier used to  
5 prepare these conjugates have the following sequence: 5'SH(CH<sub>2</sub>)<sub>6</sub>-A<sub>10</sub>-CGCATTTCAGGAT3' (SEQ ID NO:75). The linker DNA (3) has the following sequence: [5'TACGAGTTGAGAATCCTGATTGCG3'](SEQ ID NO:76). See J. J. Storhoff, R. Elghanian, R. C. Mucic, C. A. Mirkin, R. L. Letsinger, *J. Am. Chem. Soc.* **1998**, *120*, 1959. 2-Au and 3 were stored in 0.3 M NaCl, 10 mM phosphate (pH 7)  
10 buffer (0.3 M PBS) prior to use. Biotin modified DNA (2) was synthesized with Biotin TEG CPG support (Glen Research) and purified by literature methods. See J. J. Storhoff, R. Elghanian, R. C. Mucic, C. A. Mirkin, R. L. Letsinger, *J. Am. Chem. Soc.* **1998**, *120*, 1959; T. Brown, D. J. S. Brown, in *Oligonucleotides and Analogues* (Ed.: F. Eckstein), Oxford University Press, New York, **1991**.] Streptavidin was purchased from Sigma and dissolved in 20 mM Tris buffer (30 μM, pH 7.2). To make the streptavidin/DNA  
15 conjugate (1-STV), streptavidin was reacted with 8 equivalents of biotin-oligonucleotide conjugate 1 in 20 mM Tris (pH 7.2), 0.2 mM EDTA buffer solution at room temperature for 2 h on a shaker. The biotin-oligonucleotide conjugate has the sequence: [3' biotin-TEG-A<sub>10</sub>-ATGCTCAACTCT5'](SEQ ID NO:73). Mixtures with different ratios of  
20 streptavidin to DNA (1:0.4, 1:1, 1:4) were also prepared for HPLC analysis. The streptavidin/DNA conjugates were separated from excess DNA by ion exchange HPLC with 20 mM Tris (pH 7.2) and a 0.5 %/min gradient of 20 mM Tris, 1 M NaCl at a flow rate of 1 mL/min, while monitoring the UV signal of DNA at 260 nm and 280 nm. The 1:0.4 streptavidin/DNA mixture showed two peaks at 45 min and 56 min, and the 1:1  
25 mixture showed four peaks at 45 min, 56 min, 67 min and 71 min, which correspond to the 1:1, 2:1, 3:1, and 4:1 oligonucleotide-streptavidin complexes, respectively. The 1:4 mixture showed four peaks at the same positions but with increased intensity of third (67 min) and fourth (71 min) peaks. The HPLC spectrum of 1:8 streptavidin/DNA mixture

showed two main peaks, one at 59 min for unreacted DNA and the other at 71 min for the 4:1 oligonucleotide-streptavidin complex. In addition, a shoulder at 67 min assigned to 3:1 complex was also present. Purified streptavidin-biotinylated DNA conjugates were concentrated and dispersed in 0.3 M PBS by ultrafiltration (centricon 30). Aggregates for TEM, thermal denaturation experiments; and SAXS measurements were prepared by freezing the solution containing 1-STV, 2-Au, and 3 in dry ice for 10 min, and thawed prior to the measurement to facilitate hybridization.

(b) Results

10 The nanoparticle/protein assembly (Figure 52) reported herein relies on three building blocks: streptavidin complexed to four biotinylated oligonucleotides (1-STV), oligonucleotide modified gold nanoparticles (2-Au), and a linker oligonucleotide (3) that has one half of its sequence complementary to 1 and the other half complementary to 2 (see Figure 52). In a typical experiment, linker DNA 3 (10  $\mu$ M, 21  $\mu$ L) was introduced to the mixture of 2-Au (9.7 nM, 260  $\mu$ L) and 1-STV (1.8  $\mu$ M, 27  $\mu$ L), or linker DNA 3 (10  $\mu$ M, 21  $\mu$ L) was premixed with 1-STV (1.8  $\mu$ M, 27  $\mu$ L) and then the mixture was added to 2-Au (9.7 nM, 260  $\mu$ L) in 0.3 M PBS. Aggregates with similar properties could be formed by both methods, but premixing 3 and 1-STV facilitates aggregate formation. Since a 13 nm gold nanoparticle is substantially larger than streptavidin (4 nm x 4 nm x 5 nm) [P. C. Weber, D. H. Ohlendorf, J. J. Wendoloski, F. R. Salemme, *Science* **1989**, *243*, 85; N. M. Green, *Methods Enzymol.* **1990**, *184*, 51 ], a 1:20 mole ratio of Au nanoparticle to streptavidin was used to favor the formation of an extended polymeric structure rather than small aggregates comprised of a few nanoparticles or a structure consisting of a single gold nanoparticle functionalized with a hybridized layer of streptavidin.

25 Interestingly, at room temperature, when 1-STV, 2-Au, and 3 are mixed, no observable particle aggregation takes place, even after three days, as evidenced by an unperturbed UV-vis spectrum of the solution containing 1-STV, 2-Au, and 3. However,

raising the temperature of the solution (53 °C) to a few degrees below the melting temperature ( $T_m$ ) of the DNA interconnects resulted in the growth of  $\mu\text{m}$  size aggregates (Figure 57A) and the characteristic red-shift and dampening of the Au plasmon resonance associated with particle assembly. See C. A. Mirkin, R. L. Letsinger, R. C. Mucic, J. J. Storhoff, *Nature* **1996**, *382*, 607. The transmission electron microscopy (TEM) image (Figure 57B) shows that the particles within the aggregates retain their physical shape prior to and after annealing, showing no particle fusion and further demonstrating the stabilizing influence of the surface oligonucleotide layer. This requirement of thermal activation for initiating particle assembly is in contrast to the previously studied system involving two gold nanoparticle conjugates (Figure 52 b) where, under very similar conditions, the oligonucleotide-modified gold particles assemble into aggregates within a few minutes upon adding linker DNA at room temperature. See C. A. Mirkin, R. L. Letsinger, R. C. Mucic, J. J. Storhoff, *Nature* **1996**, *382*, 607. This feature could be due to: (1) the low collision probability in the Au-STV assembly system because of the relatively lower DNA coverage on streptavidin (DNA:streptavidin = 4:1) relative to that on Au nanoparticles (DNA:particle = ~110:1) [See L. M. Demers, C. A. Mirkin, R. C. Mucic, R. A. Reynolds, R. L. Letsinger, R. Elghanian, G. Viswanadham, *Anal. Chem.* **2000**, *72*, 5535] or (2) initial formation of kinetic structures in which most or all of the DNA on a single streptavidin binds to DNA on a single particle. The aggregate formation could be facilitated by freezing the solution as well as heating it. See R. Elghanian, J. J. Storhoff, R. C. Mucic, R. L. Letsinger, C. A. Mirkin, *Science* **1997**, *277*, 1078.

Melting experiments, based on UV-vis spectroscopy, were performed on the streptavidin/nanoparticle aggregates to confirm that they were formed by DNA hybridization, Figure 58A. Upon heating, the extinction at 520 nm initially decreases, resulting in a dip in the melting curve, and then abruptly increases when DNA melting takes place and the particles are dispersed. This dipping behavior has been observed in the pure gold nanoparticle system and has been attributed to aggregate growth prior to



melting, a type of aggregate "ripening". See J. J. Storhoff, A. A. Lazarides, C. A. Mirkin, R. L. Letsinger, R. C. Mucic, G. C. Schatz, *J. Am. Chem. Soc.* **2000**, *122*, 4640. After melting, the Au plasmon resonance is centered at 520 nm, which is characteristic of dispersed 13 nm nanoparticles. These experiments conclusively demonstrate that  
5 sequence specific hybridization, rather than nonspecific interactions, are effecting the particle/protein assembly and that the process is completely reversible.

An Au nanoparticle/protein assembly also could be formed through streptavidin/biotin interactions as opposed to hybridization-induced assembly. For example, in a typical experiment, **1** (0.24 mM, 1.3  $\mu$ L), **3** (10  $\mu$ M, 32  $\mu$ L) and **2**-modified  
10 nanoparticles (Au nanoparticle concentration: 9.7 nM, 260  $\mu$ L) were mixed in 0.3 M PBS buffer to generate biotin-modified Au particles. The mixture was heated to 60 °C for 10 min and then cooled to room temperature to facilitate hybridization. After 24 h, the solution containing **1**, **3**, and **2**-modified Au nanoparticles was added to streptavidin (10  $\mu$ M, 4.2  $\mu$ L) in 0.3 M PBS and heated to 50 °C to form the nanoparticle aggregates. The  
15 color of the solution turned purple indicating aggregate formation, and the aggregates could be disassembled to **2**-modified Au particles, **1**-modified streptavidin, and **3** by raising the temperature of the solution above the  $T_m$  (65 °C). Small Angle X-ray Scattering (SAXS) [S.-J. Park, A. A. Lazarides, C. A. Mirkin, P. W. Brazis, C. R. Kannewurf, R. L. Letsinger, *Angew. Chem. Int. Ed.* **2000**, *39*, 3845; A. Guinier, F. G.,  
20 *Small Angle Scattering of X-rays*, Wiley, New York, **1955**; B. A. Korgel, D. Fitzmaurice, *Phys. Rev. B* **1999**, *59*, 14191] data were collected for aggregates formed from the Au and streptavidin building blocks (**1**-STV, **2**-Au) and two different lengths of DNA linkers (24-mer (**3**) and 48-mer) and compared to those for aggregates based on Au-Au assembly and the same linking oligonucleotides (**2**-Au, **4**-Au, 24-mer linker (**3**), 48-mer linker),  
25 Figure 59. The 48-mer linker was a duplex consisting of :

5'TACGAGTTGAGACCGTTAAGACGAGGCAATCATGCAATCCTGAATGCG  
(SEQ ID NO:29) and 3'GGCAATTCCTGCTCCGTTAGTACGT (SEQ ID NO:30)(The  
duplex region is underlined.) containing 12-mer sticky ends which are complementary to

1 and 2. For design of the SAXS experiments, A<sub>10</sub> spacers in 1, 2, and 4, which were used in the above experiments to provide more accessibility for DNA hybridization [See L. M. Demers, C. A. Mirkin, R. C. Mucic, R. A. Reynolds, R. L. Letsinger, R. Elghanian, G. Viswanadham, *Anal. Chem.* **2000**, *72*, 5535, were removed to create a more rigid system. The aggregates linked by DNA showed relatively well defined diffraction peaks, and the Au-STV aggregates exhibited diffraction peaks at smaller *s* values than the Au-Au aggregates formed from the same linker. This suggests a larger Au interparticle distance in the Au-STV system. Furthermore, the diffraction peaks shift to smaller *s* values when 48-mer DNA was used as a linker instead of 24-mer for both the Au-Au and Au-STV assemblies, Figure 59.

The pair distance distribution function (PDDF),  $g(r)$ , has been calculated from the SAXS patterns using equation (1), where  $q = (4\pi/\lambda)\sin(\theta/2)$  and  $\rho$  is particle number density. [A. Guinier, F. G., *Small Angle Scattering of X-rays*, Wiley, New York, 1955; B. A. Korgel, D. Fitzmaurice, *Phys. Rev. B* **1999**, *59*, 14191].

$$g(r) = 1 + (1/2B^2 \Delta r) \int q(s(q)-1) \sin(qr) dq \quad \text{Equation (1)}$$

where  $g(r)$  gives the probability of finding a second particle as a function of distance  $r$  from a chosen particle. The nearest neighbor Au interparticle distances (center to center distance) obtained from the PDDFs are 19.3 nm, 25.4 nm, 28.7 nm, and 40.0 nm for the 24-mer linked Au-Au, 48-mer linked Au-Au, 24-mer linked Au-STV, and 48-mer linked Au-STV assemblies, respectively. A comparison of the interparticle distances for the Au-STV system and the Au-Au system clearly shows that the Au-STV assembly has the anticipated Au nanoparticle/streptavidin periodicity and that the two components (Au nanoparticle and streptavidin) are well separated by rigid DNA duplex linkers.

### (c) Conclusion

This study is important for the following reasons. 1) It demonstrates that the DNA-directed nanoparticle assembly method is extendable to protein based structures, in addition to the inorganic nanoparticles studied thus far. Indeed, this is the first report demonstrating the reversible DNA-directed assembly of Au nanoparticles and a protein

based structure functionalized with DNA. 2) It is well known that many proteins, including streptavidin, will adsorb onto the surface of colloidal gold to form strongly bound complexes. Our experiments demonstrate the stabilizing influence of the high density DNA layers on the nanoparticle surfaces and their resistance to streptavidin adsorption in the absence of hybridization. Therefore, they point towards a way of specifically immobilizing protein structures on nanoparticle surfaces through very specific interactions in a way that will not substantially perturb the activity of the protein. Particles with surface adsorbed proteins have played an important role in immunochemistry [M. A. Hayat, *Colloidal Gold: Principles, Methods, and Applications*, Academic Press, San Diego, 1991], and the development of stable protein/particle conjugates where the protein does not directly interact with the nanoparticle surface could lead to improved nanoparticle probes for histochemical studies and immunoassays.

**EXAMPLE 29: Acceleration of nanoparticles across an electric field**

The invention describes a method of moving nanoparticles such as citrate-stabilized nanoparticles and nanoparticles coated with charged biomolecules through an electric field. Nanoparticles and their use for detecting nucleic acids have been described extensively in WO 98/04740 (Northwestern University) and WO 00/33079 (Nanosphere LLC) which are incorporated herein in their entirety. Detection technologies that utilize nanoparticle probes functionalized with biomolecules rely on the ability for probe molecules to find immobilized target or capture strand oligonucleotides (in the case of a chip). This process can accelerate the movement of probes to an electrode surface with "captured target" or a set of probes that have captured target in solution to a surface of interest. The inventive method has important biodiagnostic applications that utilize nanoparticle-based probes. For example, it can be used to accelerate hybridization of a nanoparticle probe or set of probes to a surface functionalized with complementary DNA or a complementary antigen/antibody.

The concept of applying an electric field to promote active movement of

biological molecules such as DNA in an electric field towards a targeted site in a fluorometric hybridization detection system has been described, for instance, in U.S. Patent Nos. 5,849,486. However, none of these patents describe the application of an electric field to accelerate movement of nanoparticles bound to biomolecules to a target site.

To examine the effect of electric field on the transport of DNA-modified nanoparticles, 13 nm gold nanoparticles were modified with 3' propanethiol-capped 22-mer DNA, and the modified particles were dispersed in water. A Keithley 487 picoammeter/voltage source (Keithley Instruments, Inc., 28775 Aurora Road, Cleveland, Ohio, USA, Catalog No. 487 picoammeter) was used to apply a DC electric field across two indium-tin-oxide (ITO) electrodes and measure the current. See Figure 1 illustrating the electrode and migration of the nanoparticles. The ITO coated glass (Delta Technologies, Ltd., Stillwater, MN, USA (Part No. CD-50IN-CUV) were cut by 0.8 x 1 cm. Two indium-tin-oxide coated glass substrates were employed as a cathode and anode. The electrodes were dipped in a solution of DNA-modified nanoparticles, and a 3 V DC electric field was applied (4  $\mu$ A) for 15 min. After application of the field, the electrodes were washed with water. A pink color was observed on the positively-biased electrode (anode) while there was no visible change on the cathode. The capturing of the nanoparticles on the anode was confirmed by enhancing the signal with silver via a solution of Ag(I) and hydroquinone. Both electrodes were immersed in the silver staining solution for 3 min. The anode turned black, and there was no substantive change for the cathode. This observation indicates that DNA-modified particles can be transported by electric field due to the high negative charge on the particles, and it shows that the electric field can be utilized to facilitate hybridization of DNA-modified particles to the complementary oligonucleotides on an electrode surface. It further suggests that this could be extended to other biorecognition processes that involve charged particles.

Example 30: Two-color Labeling of Oligonucleotide Arrays via Size-Selective Scattering of Nanoparticle Probes

In this Example, two-color labeling of oligonucleotide arrays using two different sized nanoparticle oligonucleotide conjugates of the invention to detect two different target nucleic acid sequences in an aqueous sample is described. The DNA sequences of the array capture strands, the oligonucleotide-functionalized nanoparticle labels, and the targets to be detected were designed to cohybridize in a three-component sandwich assay (Figure 61). [Taton, T.A.; Mirkin, C.A.; Letsinger, R.L. *Science* **200**, 289, 1757].

Test oligonucleotide targets were synthesized by automated solid phase synthesis, and oligonucleotide arrays were fabricated on glass microscope slides using literature procedures. [Taton, T.A.; Mirkin, C.A.; Letsinger, R.L. *Science* **200**, 289, 1757; Chrisey, L.A.; Lee, G.U.; O'Ferrall, C.E. *Nucl. Acids Res.* **1996**, *24*, 3031.] 50 nm and 100 nm diameter gold nanoparticles were functionalized with dithiane-terminated oligonucleotides and isolated by literature methods. [Reynolds, R.A. III; Mirkin, C.A.; Letsinger, R.L. *J. Am. Chem. Soc.* **2000**, *122*, 3795; Letsinger, R.L.; Elghanian, R.; Viswanadham, G; Mirkin, C.A. *Bioconjugate Chem.* **2000**, *11*, 289], In a typical experiment, oligonucleotide-nanoparticle conjugates and oligonucleotide targets were cohybridized to the DNA arrays in 0.3 M PBS hybridization buffer [0.3 M NaCl, 10 nM NaH<sub>2</sub>PO<sub>4</sub>/Na<sub>2</sub>HPO<sub>4</sub>, pH 7] at room temperature for 2 h. [ See Examples 30 and 31 below]. The arrays were then washed with clean buffer to remove unhybridized target and nanoparticle probes. The array slides were mounted on a microscope stage and illuminated in the plane of the slide by a fiber optic illuminator [Darklite Illuminator (Micro Video Instruments, Avon, MA)]; in this configuration, the slide served as a planar waveguide, preventing any light from reaching the microscope objective by total internal reflectance. Wherever nanoparticle probes were attached to the surface of the waveguide, however, evanescently coupled light [Müller, G.J. In *Multichannel Image Detectors*; Talmi, Y., Ed.; ACS Symposium Series 102; American Chemical Society: Washington, DC, 1979; pp 239-262] was scattered out of the guide plane and was imaged as bright,

colored spots on a dark background. In these experiments, green light ( $\lambda_{\max} = 542$  nm) was observed wherever 50 nm Au particles were attached to the waveguide, and orange light ( $\lambda_{\max} = 583$  nm) was similarly observed for attached 100 nm particles. Although scattering of light from large ( $\geq 200$  nm) selenium particles attached to planar waveguides has been used to image DNA arrays [Stimpston, D.I.; Hoijer, J.V.; Hsieh, W.; Jou, C.; Gordon, J.; Theriault, T.; Gamble, R.; Baldeschwieler, J.D. *Proc. Natl. Acad. Sci. USA* 1995, 92, 6379], two features of the system we describe herein distinguish it from previous work: i) the remarkable sequence selectivity caused by the sharp melting profiles inherent to densely functionalized, oligonucleotide-gold nanoparticle hybrids, and ii) the observation that different particle sizes, and in principle, different particle compositions, provide multicolor analysis of oligonucleotide arrays.

#### A. General Experimental Methods

Automated oligonucleotide synthesis was performed on an Expedite 8909 Nucleic Acid Synthesizer (Applied Biosystems, Foster City, CA) using standard phosphoramidite chemistry. All the reagents required for oligonucleotide synthesis were purchased from Glen Research, Sterling, VA. For all experiments nanopure water (18.1 M $\Omega$ ) purified with a Barnstead (Dubuque, IA) NANOpure water system was used. UV-Vis spectra were measured on a Hewlett-Packard (Palo Alto, CA) 8452A diode array spectrophotometer. HPLC was performed using a Hewlett-Packard Series 1100 HPLC.

#### 20 B. Preparation of 5'-steroid disulfide oligonucleotide-modified Au nanoparticles

Aqueous solutions of 50 nm and 100 nm diameter gold nanoparticles (British BioCell International, UK) were used as received. (Product data, 50 nm Au: 70 fM; 100 nm Au: 9.3 fM.) To 10 mL of gold colloid solution was added 1.5 nmol of 5'-steroid disulfide-modified oligonucleotide, prepared using literature procedures [Letsinger, R.L.; Elghanian, R.; Viswanadham, G.; Mirkin, C.A. *Bioconjugate Chem.* 2000, 11, 289], in water. The solution was brought to 0.3 M NaCl, 10 mM NaH<sub>2</sub>PO<sub>4</sub>/Na<sub>2</sub>HPO<sub>4</sub> pH 7 buffer (0.3 M PBS) gradually by adding aliquots of 2 M NaCl and 0.1 M

NaH<sub>2</sub>PO<sub>4</sub>/Na<sub>2</sub>HPO<sub>4</sub>, pH 7 buffer solutions every 4 hours. After 48 hours, the particle solutions were centrifuged (for 50 nm gold nanoparticles: 5000 rpm for 10 min, for 100 nm gold nanoparticles: 2500 rpm for 10 min) in an ultracentrifuge (Avanti 30, Beckman Instruments, Fullerton, CA) to yield a colorless supernatant above a dark red oily precipitate. Upon removing the colorless supernatant, the dark red oily precipitate was redispersed in fresh 0.3 M PBS buffer (7 mL and 4 mL for 50 nm and 100 nm gold colloids). Centrifugation and redispersion was repeated twice. The final concentrations of the product nanoparticle solutions were estimated from their measured visible absorption of 520 nm and published values for extinction coefficients of the unmodified particles [Yguerabide, J. and Yguerabide, E.E. *Anal. Biochem.* **1998**, *262*, 137](50nm Au nanoparticles:  $\epsilon_{520} = 4.4 \times 10^{10} \text{ M}^{-1} \text{ cm}^{-1}$ ; 100nm Au nanoparticles:  $\epsilon_{520} = 1.6 \times 10^{11} \text{ M}^{-1} \text{ cm}^{-1}$ ). For the experiments described below, the concentrations of 50 nm and 100 nm diameter, steroid disulfide oligonucleotide-modified Au nanoparticles were 30 nM and 3.5 nM, respectively.

15 C. Fabrication of DNA microarrays

Glass microscope slides (Fisher Scientific, Springfield, NJ) were functionalized with reactive maleimide groups capable of binding thiol-modified oligonucleotides using a modification of the procedure published by Chrisey et al. [Chrisey, L.A.; Lee, G.U.; O'Ferrall, C.E. *Nucl. Acids Res.* **1996**, *24*, 3031]. Slides were first cleaned in piranha solution (3:1 concentrated H<sub>2</sub>SO<sub>4</sub>:30% H<sub>2</sub>O<sub>2</sub>) for 15 min and rinsed with copious amounts of nanopure water. *Warning: piranha solution is highly reactive and should be used with caution.* The slides were then immersed in a solution of 1% (v/v) solution of 3-aminopropyltrimethoxysilane (APS) in 1mM acetic acid for 30 min. APS-modified slides were rinsed thoroughly with nanopure water and ethanol, dried under N<sub>2</sub> and baked at 120-130 °C for 20 min. Upon cooling, silanized slides were immediately treated with 2mM solution of succinimidyl 4-[maleimidophenyl]-butyrate (SMPB) in 4:1 ethanol:DMSO. The slides were allowed to soak in the SMPB solution overnight, rinsed with ethanol and dried under N<sub>2</sub>. The slides were subsequently immersed in 1:1:4 acetic

anhydride:pyridine:DMF for 2h, washed with water and dried under N<sub>2</sub>. The SMPB-modified slides were then loaded into a robotic microarrayer (GMS 417, Genetic Microsystems Inc, Woburn, MA), and spotted with 1mM solutions of 3'-thiol-modified capture oligonucleotides (synthesized by literature procedures [Storhoff, J.J.; Elghanian, R.; Mucic, R.C.; Mirkin, C.A.; Letsinger, R.L. *J. Am. Chem. Soc.* **1998**, *120*, 1959]) using 5 150 μm diameter spotting pins. After spotting, the slides were placed in a humidity chamber (Hybaid US, Franklin, MA), and allowed to stand overnight. The slides were rinsed with water and dried under N<sub>2</sub> followed by soaking in 2% (w/v) mercaptohexane in ethanol for 1h. The slides were removed from the solution, rinsed with copious 10 amounts of ethanol, and dried under N<sub>2</sub>.

D. Two-color labeling of two oligonucleotide targets with nanoparticle probes

A 100 μL hybridization well (Grace BioLabs, Bend, OR) was attached to an oligonucleotide array spotted with thiol-modified oligonucleotides of sequences *c* and *d* 15 (see Figure 62 caption for sequences). The well was filled with a 0.3 M PBS buffer solution (0.3 M NaCl, 10 mM NaH<sub>2</sub>PO<sub>4</sub>/Na<sub>2</sub>HPO<sub>4</sub>, pH 7) made 10 nM in 50 nm diameter gold nanoparticles functionalized with oligonucleotide sequence *a*, 3.5 nM in 100 nm diameter gold nanoparticles functionalized with oligonucleotide sequence *b*, and 200 nM in oligonucleotide target(s) *a'c'* and/or *b'd'*. After covering the well with a glass 20 coverslip, the slide assembly was shaken for 2 h at room temperature, the hybridization well removed, and the array washed three times with clean 0.15 M PBS buffer (0.15 M NaCl, 10mM NaH<sub>2</sub>PO<sub>4</sub>/Na<sub>2</sub>HPO<sub>4</sub>, pH 7). A new hybridization well was attached to the slide and filled with fresh 0.15 M PBS buffer, and the slide assembly was mounted in a 25 fiber optic illuminator (Darklite Illuminator, Micro Video Instruments, Avon, MA) on an inverted microscope (Axiovert 100A, Carl Zeiss, Jena, Germany) for imaging, as shown in Figure 64. Illumination was provided by a 200 W halogen source (Fiber-Lite PL-750, Dolan-Jenner, Lawrence, MA) set to 40% intensity and allowed to equilibrate for at least 15 min before imaging. Images were captured with a Penguin 600 CL digital camera (Pixera, Los Gatos, CA).



E. Spectral analysis of particles bound to oligonucleotide-functionalized surfaces.

Glass slides were first functionalized with either DNA sequence *c* or *d* over their entire surface by the method described above for DNA microarray fabrication, except that spotting of an array was replaced by immersion of the entire slide in 1mM 3'-thiol-  
5 modified capture oligonucleotide *c* or *d*. Slides bearing capture strand *c* were then exposed to 100  $\mu$ L of a 0.3 M PBS buffer solution made 10nM in 50 nm diameter gold nanoparticles functionalized with oligonucleotide sequence *a* and 200 nM in oligonucleotide target *a'c'* as described for the two-color array imaging experiments  
10 above; similarly, slides bearing capture strand *d* were then exposed to 100  $\mu$ L of a 0.3 M PBS buffer solution made 3.5 nM in 100 nm diameter gold nanoparticles functionalized with oligonucleotide sequence *b* and 200 nM in oligonucleotide target *b'd'*. These slides were washed with fresh buffer and mounted in the fiber optic illuminator as described above. The microscope objective was replaced with the input to a fiber optic  
15 spectrometer (USB2000, Ocean Optics, Inc., Dunedin, FL), and spectra were recorded for the slide-bound 50 nm and 100 nm Au particles. These spectra are shown in Figure 66. For 50 nm particles,  $\lambda_{\max} = 542$  nm and the full width at half-maximum (FWHM) of the scattering peak is 86 nm; for 100 nm particles,  $\lambda_{\max} = 583$  nm and FWHM = 114 nm.

F. Conclusion

20 In order to test the potential of this system to do multiple-color analysis of two different DNA targets in one solution, a mixture of 10 nM 50 nm particles functionalized with DNA sequence *a*, 3.5 nM 100 nm Au particles functionalized with DNA sequence *b*, and 200 nM synthetic oligonucleotide targets *a'c'* and *b'd'* was exposed to a glass slide spotted with sequences *c* and *d* (Figure 61A) [Further details of array hybridization,  
25 imaging and sensitivity can be found in Examples 30 and 31]. In the presence of both targets *a'c'* and *b'd'* the two different nanoparticle probes were successfully and independently hybridized to the corresponding complementary slide spots, as demonstrated by the scattered green light imaged at the test spot for sequence *a'c'* and the scattered orange light at the test spot for sequence *c'd'* (Figure 62A). The low

scattered light intensity measured away from the spots is a reflection of minimal nonspecific binding of the nanoparticles to the slide surface. In the presence of only target *a'c'* or *b'd'*, only the green light or the orange light is observed, respectively (Figure 62B,C). Little background signal is observed in either case at the  
5 noncomplementary spot. Scattered light due to hybridized nanoparticle probes could be distinguished from background signal in the presence of as little as 1 pM of target [Further details of array hybridization, imaging and sensitivity can be found in Examples 30 and 31], indicating that the method is sensitive enough for the analysis of DNA from biological sources. Note that no scattered light was observed when the DNA  
10 functionalized microscope slide was treated with the two different nanoparticle probes in the absence of targets (Figure 62D).

Example 31: Array sequence selectivity/melting experiments

In this Example, model DNA arrays were prepared to evaluate the selectivity of  
15 the inventive scattering detection method described in Example 30. To test the selectivity of this new scattering detection system based on nanoparticle probes, we synthesized model DNA arrays containing four elements, with each element bearing capture strands containing one of the four possible nucleotides at a particular sequence position. These arrays were incubated at room temperature with a solution which was 200 nM in a target  
20 complementary to one of the four elements ( $X=A$ , Figure 61B) and 10 nM in 50 nm diameter nanoparticle probes. The arrays were then washed to remove unhybridized target and probes and resubmerged in clean hybridization buffer. The dissociation of the hybridized nanoparticles from the array surface was then induced and continuously observed by gradually raising the temperature of the buffer. As long as this temperature  
25 did not exceed the melting temperature ( $T_m$ ) of either the complementary or the mismatched DNA duplexes, scattered light was observed at all four array elements (Figure 63A), indicating that no dissociation had taken place. However, as the temperature of the buffer was further increased, the nanoparticle probes dissociated from

the slide in the order of the thermal stability of the varied base pair (T:T about equal to C:T < G:T < A:T, Figure 63A). Because the dissociation of nanoparticles from the slide was observed in real time, the optimal stringency temperature, selectivity, and target sequence could all readily be determined visually as the experiment progressed. In addition, quantitative melting profiles for all array elements were generated and compared simultaneously by measuring the signal intensity at each element in real time (Figure 63B). At the temperature of optimal stringency (55°C, shown by the vertical line in Figure 63B), the signal at the complementary (X = A) element is five times higher than that of the element containing a G:T “wobble” mismatch. This represents significantly higher sequence selectivity than previously observed for molecular fluorophore probes and arrays with identical sequences [Taton, T.A.; Mirkin, C.A.; Letsinger, R.L. *Science* **200**, 289, 1757]. As was observed for small (13 nm diameter) nanoparticles via the black and white scanometric approach [Taton, T.A.; Mirkin, C.A.; Letsinger, R.L. *Science* **200**, 289, 1757], the higher selectivity of the 50 nm particle probes compared to fluorophore-labeled DNA is a direct consequence of the narrow temperature range over which the nanoparticles dissociate from the array surface; the full width at half maximum for the first derivative of the curves shown in Figure 63B is 5°C, compared to 18°C for fluorophore-labeled DNA with identical sequences [Taton, T.A.; Mirkin, C.A.; Letsinger, R.L. *Science* **200**, 289, 1757]. The results presented here demonstrate that this selectivity also can be used in conjunction with multicolor labeling of multiple DNA targets on the same chip.

A. Array selectivity measurements

An oligonucleotide array was first fabricated by spotting with the four thiol-modified oligonucleotide sequences shown in Figure 61B. A 100  $\mu$ L hybridization well as attached to the array and filled with a 0.3 M PBS buffer solution made 10 nM in oligonucleotide-functionalized 50 nm diameter gold nanoparticle probes and 200 nM in a 30-mer oligonucleotide target bearing an thymidine at position 8 (complementary to the chip sequence with X = A, Figure 61B). The slide assembly was shaken for 2 h at room

temperature, the hybridization well removed, and the array washed three times with clean 0.15 M PBS buffer. A new hybridization well was attached to the slide and filled with fresh 0.15 M PBS buffer and a small stirbar (2 mm x 7 mm, Fisher Scientific). The slide was mounted on an inverted microscope equipped with a controlled temperature stage .

5 mount (BS60, Instec Inc., Boulder Co) and a miniature magnetic stirrer (Telemodul Mini, H+P Labortechnik, Munich, Germany) as shown in Figure 65A (top view) and S2B (side view). The assembly was subjected to a temperature ramp from 25 °C to 75 °C at a rate of 0.5°C/min with a 3 min hold at each temperature. Images were captured as described above, and analyzed using image processing software (Adobe Photoshop 5.0, Adobe

10 Systems, San Jose, CA). Signal intensities at each array element were quantified by selecting a circular area inside the array spot and averaging the luminosity value given by Photoshop for the selected pixels.

#### B. Array sensitivity measurements

Arrays were prepared and incubated with 50 nm nanoparticle probes (10 nM in

15 0.3 M PBS) and oligonucleotide target as described above for the selectivity experiments, but with target concentrations varying from 1  $\mu$ M down to 10 fM. The slide assembly was shaken for 2 h at room temperature, the hybridization well removed, and the array washed three times with clean 0.15 M PBS buffer. A new hybridization well as attached to the slide and filled with fresh 0.15 M PBS buffer, and the slide assembly was mounted

20 in the fiber optic illuminator for quantitation of signal. The data obtained is shown in Figure 67. The lowest concentration that can be statistically distinguished from background ( $> 2\sigma$ ) is 1 pM.

#### C. Conclusion

The DNA array imaging technique described in this Example and in Example 30

25 above, based on scattered light from larger oligonucleotide-functionalized nanoparticles, provides the opportunity for sensitive, ultrasensitive, multicolor labeling of DNA arrays. In theory, the method described will be extendable to additional colors using nanoparticles of different compositions and sizes [Link, S.; Wang, Z.L.; El-Sayed, M.A.

*J. Phys. Chem. B* **1999**, *103*, 3529]. In addition, the use of particles with higher scattering coefficients may permit this system to rival the high sensitivity of the scanometric nanoparticle system<sup>5</sup> and waveguide-based fluorescence arrays [Budach, W.; Abel, A.P.; Bruno, A.E.; Neuschäfer, D. *Anal. Chem.* **1999**, *71*, 3347].

5

Example 32: Assay-based electrical detection of DNA using nanoparticle probes and a salt-based stringency wash

In this Example, a model DNA array was prepared to evaluate the unusual salt-  
10 dependence on the melting properties of the hybridized particles and the use of a salt-based stringency wash, in place of a thermal stringency wash, to differentiate binding events involving mismatched strands from ones based upon perfectly complementary recognition elements.

A. Microelectrode preparation

15 In a typical experiment, microelectrodes (60 nm Au on 5nm Ti) with 20  $\mu\text{m}$  gaps were prepared by standard photolithography on a Si wafer with 1000 angstrom coating of SiO<sub>2</sub> (Figure 68C). The exposed SiO<sub>2</sub> of the entire chip was modified with succinimidyl 4-[maleimidophenyl]-butyrate (SMPB, Sigma Chemical, St. Louis, MO) using literature methodology (T. A. Taton, C. A. Mirkin, R. L. Letsinger, *Science* **289**, 1757 (2000); L.  
20 A. Chrisey, G. U. Lee, C. E. O'Ferrall, *Nucl. Acids Res.* **24**, 3031-3039 (1996)). Capture oligonucleotide strands were immobilized onto the activated surface by spotting 0.3 M NaCl, 10 mM phosphate buffer (pH7) solutions (0.3 M PBS) of the appropriate alkylthiol-modified oligonucleotide (1 mM) in the electrode gaps by manual pipetting. All the oligonucleotides used in this study were prepared by automated solid phase  
25 syntheses (J. J. Storhoff, R. Elghanian, R. C. Mucic, C. A. Mirkin, R. L. Letsinger, *J. Am. Chem. Soc.* **120**, 1959-1964 (1998), F. Eckstein, *Oligonucleotides and Analogues* (Oxford University Press, New York, ed. 1<sup>st</sup>, 1991)) and the sequences of capture, target, and probe DNA strands are given in Figure 68B. The DNA chip arrays were designed to evaluate the discrimination of the complementary pair, A:T (X=A), from the three single-

base mismatches, T:T (X=T), C:T (X=C), or G:T (X=G) in a synthetic 27-base oligonucleotide target (based on the anthrax lethal factor sequence) (S. Ikuta, K. Takagi, R. B. Wallace, K. Itakura, *Nucl. Acids Res.* 15, 797 (1987)). After spotting capture oligonucleotides in the electrode gaps, the chip was stored in a humidity chamber for 24 h  
5 allowing the coupling reaction between the SMPB and alkylthiol capped DNA to take place. The chip was then washed with water and immersed in 2% mercaptohexanol in ethanol for 2 h to passivate the chip, including the Au electrodes. Finally, the DNA-functionalized chip was washed with ethanol and water and then dried under a stream of N<sub>2</sub>.

10 B. Array selectivity measurements following salt stringency wash

To evaluate the detection capabilities of the array, the chip was treated with 0.3 M PBS solution of target DNA (10 nM) for 4 h, then rinsed with 0.3 M PBS solution. Thereafter, the chip was treated with a 0.3 M PBS solution of nanoparticle probes (2 nM) for 2 h. The DNA chip was rinsed with 0.3 M NaNO<sub>3</sub> in 10 mM phosphate buffer (pH 7)  
15 to remove chloride ions and then treated with a silver enhancer solution (Sigma Chemical, St. Louis, MO), which is composed of AgNO<sub>3</sub> and hydroquinone. The silver enhancer solution was replaced every 2 or 3 minutes to avoid the formation of silver particulate in solution. After each treatment of the chip with the silver enhancer solution, the chip was rinsed with water, dried with N<sub>2</sub>, and the resistance values across the  
20 electrode gaps were measured using a Fluke 189 multimeter (Fluke, Everett, WA). After a 3 minute treatment with silver enhancer solution, the gaps with the four different oligonucleotide capture strands exhibit gap resistances larger than 500 MΩ, the limit of the multimeter used in the experiment, Figure 69A. In the absence of a stringency wash, the gap resistances decrease with increasing exposure to the silver enhancer solution. In  
25 a separate experiment, filed emission scanning electron microscope (FE-SEM) images of an indium tin oxide (ITO) surface, treated in a manner identical to the electrode gaps, before and after silver deposition show that silver deposition increases with increasing exposure to the silver enhancer solution, Figure 70A-D. Interestingly, the particles all

exhibit different growth rates. In fact, even after nine minutes of exposure to the enhancer solution, some particles remain unaffected in terms of size and shape. This indicates that the nanoparticles initiate the silver deposition, but deposited silver further catalyzes the silver reduction, which is ultimately responsible for closing the circuit, rather than a process that results in uniform particle growth with eventual electrical shorting of those particles. The particles are complex materials and when considered on an individual basis, must have slightly different levels of oligonucleotide functionalization and, therefore, different activities with respect to their ability to promote the reduction of  $\text{Ag}^+$  to Ag by hydroquinone. In the absence of target DNA, there was no detectable signal even after 40 minutes of silver enhancing. Using this detection method, target at 500 fM concentration was detected without effort to optimize the system. The detection limit of a conventional system based on fluorescence that utilizes a confocal microscope, these oligonucleotide strands, and a Cy3-modified probe is  $\sim 5$  pM (T. A. Taton, C. A. Mirkin, R. L. Letsinger, *Science* **289**, 1757 (2000)).

A conventional way of increasing target selectivity is to wash a DNA chip array with a buffer solution at a temperature that results in the dehybridization of DNA duplexes formed from noncomplementary strands (G. H. Keller, M. M. Manak, *DNA Probes* (Stockton Press, New York, 1989)). It was previously shown that other nanoparticle-based DNA detection methods exhibit unusually high specificity due to the sharp melting transitions associated with duplex structures formed from oligonucleotide-modified probes and complementary oligonucleotides (T. A. Taton, C. A. Mirkin, R. L. Letsinger, *Science* **289**, 1757 (2000)). Therefore, for the system reported herein, one might expect to see a difference in resistance between the gaps modified with the perfectly complementary capture strand as compared with the gaps modified with the noncomplementary strands, when washed with a stringency solution at the appropriate temperature. Indeed, when the chip was washed with 0.3 M PBS at 50°C prior to treatment with the silver enhancer solution, the resistance for the gaps with the complementary capture strand decreases with Ag enhancing time over a 3-15 minute

range, but all three of the gaps with the single base mismatches show resistances larger than 500 M $\Omega$ , even after 20 minutes of enhancing time. In other words, a complementary strand in this experiment provides a signal that is at least 10<sup>5</sup> times greater than the noncomplementary strands. This is an impressive level of selectivity when one compares this value to the selectivity ratio observed in the comparable fluorescence based approach (2.6:1) and even the previously reported scanometric approach (11:1) (T. A. Taton, C. A. Mirkin, R. L. Letsinger, *Science* **289**, 1757 (2000)).

Significantly, it was found that oligonucleotide-modified nanoparticles exhibit unusually sharp denaturation properties over salt concentration gradients, Figure 69C. Indeed, by examining the absorbance at 520 nm of two glass cuvettes functionalized with the complementary capture strand/target strand/probe complex and the capture strand with G-T mismatch/target/probe complex, respectively, as function of solution Na<sup>+</sup> concentration, the mismatched oligonucleotides can be easily differentiated from the complementary target. Significantly, one obtains better differentiation of the two strands using changes in salt concentration as opposed to changes in temperature, Figure 69C (inset). Therefore, the nanoparticle probes on mismatched DNA can be selectively dehybridized by washing the chip with a buffer solution of the proper cation concentration. After a stringency wash of the chip with 0.01 M PBS at room temperature, the resistance of the gap with the perfectly complementary DNA (X = A) significantly decreases with silver deposition while all three gaps functionalized with the mismatched strands (X = T, G, or C) remain insulating, even after 20 minutes of enhancing time. In control experiments, when the DNA chip was washed with water in order to denature all of the duplex strands, there was no detectable signal for all four DNA strands after 40 minutes of silver enhancing.

### 25 C. Conclusion

In conclusion, a new electrical array-based DNA detection method with high sensitivity and ultrahigh specificity has been discovered, and has been demonstrated that stringency based on adjusting salt concentration of wash buffer solutions not only can be



used to replace temperature-based stringency formats in this novel detection format but, in the case of nanoparticle probes, is superior. Indeed, the use of salt concentration as a stringency tool rather than temperature is important for at least the reasons that it points towards a general way of eliminating the need for thermocyclers in nanoparticle-based detection systems; it offers higher selectivity than temperature-based stringency for nanoparticle probes; and is useful where the detection probe are not stable at elevated temperature. Finally, since this system is based upon conventional microelectrodes, it is useful for massive multiplexing through the use of larger arrays of electrode pairs than the four used in this Example. Taken together, the invention is useful for portable, point-of-site DNA detection method for single-nucleotide polymorphism screening, and although the sensitivity of this system has not been fully optimized, it already is superior to the analogous fluorescence-based approach based on a confocal fluorescence microscope. By decreasing gap size, which will decrease the number of particles required to close the circuit, the sensitivity of this system should be dramatically improved.

All patents, patent applications and references cited herein are hereby incorporated by reference in their entirety.

WE CLAIM:

1. A method of detecting a nucleic acid having at least two portions  
comprising:
  - 5 providing a type of nanoparticles having oligonucleotides attached thereto, the oligonucleotides on each nanoparticle having a sequence complementary to the sequence of at least two portions of the nucleic acid;
  - contacting the nucleic acid and the nanoparticles under conditions effective to allow hybridization of the oligonucleotides on the nanoparticles with the two or more  
10 portions of the nucleic acid; and
  - observing a detectable change brought about by hybridization of the oligonucleotides on the nanoparticles with the nucleic acid.
  
2. A method of detecting nucleic acid having at least two portions  
15 comprising:
  - contacting the nucleic acid with at least two types of nanoparticles having oligonucleotides attached thereto, the oligonucleotides on the first type of nanoparticles having a sequence complementary to a first portion of the sequence of the nucleic acid, the oligonucleotides on the second type of nanoparticles having a sequence  
20 complementary to a second portion of the sequence of the nucleic acid, the contacting taking place under conditions effective to allow hybridization of the oligonucleotides on the nanoparticles with the nucleic acid; and
  - observing a detectable change brought about by hybridization of the oligonucleotides on the nanoparticles with the nucleic acid.
  
- 25 3. The method of Claim 2 wherein the contacting conditions include freezing and thawing.

4. The method of Claim 2 wherein the contacting conditions include heating.
5. The method of Claim 2 wherein the detectable change is observed on a solid surface.
- 5 6. The method of Claim 2 wherein the detectable change is a color change observable with the naked eye.
7. The method of Claim 6 wherein the color change is observed on a solid  
10 surface.
8. The method of Claim 2 wherein the nanoparticles are made of gold.
9. The method of Claim 2 wherein the oligonucleotides attached to the  
15 nanoparticles are labeled on their ends not attached to the nanoparticles with molecules that produce a detectable change upon hybridization of the oligonucleotides on the nanoparticles with the nucleic acid.
10. The method of Claim 9 wherein the nanoparticles are metallic or  
20 semiconductor nanoparticles and the oligonucleotides attached to the nanoparticles are labeled with fluorescent molecules.
11. The method of Claim 2 wherein:  
the nucleic acid has a third portion located between the first and second  
25 portions, and the sequences of the oligonucleotides on the nanoparticles do not include sequences complementary to this third portion of the nucleic acid; and  
the nucleic acid is further contacted with a filler oligonucleotide having a sequence complementary to this third portion of the nucleic acid, the contacting taking

place under conditions effective to allow hybridization of the filler oligonucleotide with the nucleic acid.

12. The method of Claim 2 wherein the nucleic acid is viral RNA or DNA.
- 5 13. The method of Claim 2 wherein the nucleic acid is a gene associated with a disease.
14. The method of Claim 2 wherein the nucleic acid is a bacterial DNA.
- 10 15. The method of Claim 2 wherein the nucleic acid is a fungal DNA.
16. The method of Claim 2 wherein the nucleic acid is a synthetic DNA, a synthetic RNA, a structurally-modified natural or synthetic RNA, or a structurally-modified natural or synthetic DNA.
- 15 17. The method of Claim 2 wherein the nucleic acid is from a biological source.
18. The method of Claim 2 wherein the nucleic acid is a product of a  
20 polymerase chain reaction amplification.
19. The method of Claim 2 wherein the nucleic acid is contacted with the first and second types of nanoparticles simultaneously.
- 25 20. The method of Claim 2 wherein the nucleic acid is contacted and hybridized with the oligonucleotides on the first type of nanoparticles before being contacted with the second type of nanoparticles.

21. The method of Claim 20 wherein the first type of nanoparticles is attached to a substrate.

22. The method of Claim 2 wherein the nucleic acid is double-stranded and hybridization with the oligonucleotides on the nanoparticles results in the production of a triple-stranded complex.

23. A method of detecting nucleic acid having at least two portions comprising:

10 providing a substrate having a first type of nanoparticles attached thereto, the nanoparticles having oligonucleotides attached thereto, the oligonucleotides having a sequence complementary to a first portion of the sequence of a nucleic acid to be detected;

15 contacting said nucleic acid with the nanoparticles attached to the substrate under conditions effective to allow hybridization of the oligonucleotides on the nanoparticles with said nucleic acid;

providing a second type of nanoparticles having oligonucleotides attached thereto, the oligonucleotides having a sequence complementary to one or more other portions of the sequence of said nucleic acid;

20 contacting said nucleic acid bound to the substrate with the second type of nanoparticles under conditions effective to allow hybridization of the oligonucleotides on the second type of nanoparticles with said nucleic acid; and

observing a detectable change.

25 24. The method of Claim 23 wherein the substrate has a plurality of types of nanoparticles attached to it in an array to allow for the detection of multiple portions of a single nucleic acid, the detection of multiple different nucleic acids, or both.

25. A method of detecting nucleic acid having at least two portions comprising:

providing a substrate having a first type of nanoparticles attached thereto, the nanoparticles having oligonucleotides attached thereto, the oligonucleotides having a sequence complementary to a first portion of the sequence of a nucleic acid to be detected;

5 contacting said nucleic acid with the nanoparticles attached to the substrate under conditions effective to allow hybridization of the oligonucleotides on the nanoparticles with said nucleic acid;

10 providing a second type of nanoparticles having oligonucleotides attached thereto, the oligonucleotides having a sequence complementary to one or more other portions of the sequence of said nucleic acid;

contacting said nucleic acid bound to the substrate with the second type of nanoparticles under conditions effective to allow hybridization of the oligonucleotides on the second type of nanoparticles with said nucleic acid;

15 providing a binding oligonucleotide having a selected sequence having at least two portions, the first portion being complementary to at least a portion of the sequence of the oligonucleotides on the second type of nanoparticles;

20 contacting the binding oligonucleotide with the second type of nanoparticles bound to the substrate under conditions effective to allow hybridization of the binding oligonucleotide to the oligonucleotides on the nanoparticles;

providing a third type of nanoparticles having oligonucleotides attached thereto, the oligonucleotides having a sequence complementary to the sequence of a second portion of the binding oligonucleotide;

25 contacting the third type of nanoparticles with the binding oligonucleotide bound to the substrate under conditions effective to allow hybridization of the binding oligonucleotide to the oligonucleotides on the nanoparticles; and

observing a detectable change.

26. The method of Claim 25 wherein the substrate has a plurality of types of nanoparticles attached to it in an array to allow for the detection of multiple portions of a single nucleic acid, the detection of multiple different nucleic acids, or both.

5

27. A method of detecting nucleic acid having at least two portions comprising:

contacting a nucleic acid to be detected with a substrate having oligonucleotides attached thereto, the oligonucleotides having a sequence complementary to a first portion of the sequence of said nucleic acid, the contacting taking place under conditions effective to allow hybridization of the oligonucleotides on the substrate with said nucleic acid;

10 contacting said nucleic acid bound to the substrate with a first type of nanoparticles having one or more types of oligonucleotides attached thereto, at least one of the types of oligonucleotides having a sequence complementary to a second portion of the sequence of said nucleic acid, the contacting taking place under conditions effective to allow hybridization of the oligonucleotides on the nanoparticles with said nucleic acid;

15 contacting the first type of nanoparticles bound to the substrate with a second type of nanoparticles having oligonucleotides attached thereto, the oligonucleotides on the second type of nanoparticles having a sequence complementary to at least a portion of the sequence of one of the types of oligonucleotides on the first type of nanoparticles, the contacting taking place under conditions effective to allow hybridization of the oligonucleotides on the first and second types of nanoparticles; and  
observing a detectable change.

25

28. The method of Claim 27 wherein the first type of nanoparticles has only one type of oligonucleotides attached thereto, the oligonucleotides having a sequence complementary to the second portion of the sequence of said nucleic acid and to at least a

portion of the sequence of the oligonucleotides on the second type of nanoparticles.

29. The method of Claim 28 further comprising contacting the second type of nanoparticles bound to the substrate with the first type of nanoparticles, the contacting  
5 taking place under conditions effective to allow hybridization of the oligonucleotides on the first and second types of nanoparticles.

30. The method of Claim 27 wherein the first type of nanoparticles has at least two types of oligonucleotides attached thereto, the first type of oligonucleotides having a  
10 sequence complementary to the second portion of the sequence of said nucleic acid, and the second type of oligonucleotides having a sequence complementary to the sequence of at least a portion of the oligonucleotides on the second type of nanoparticles.

31. The method of Claim 30 further comprising contacting the second type of nanoparticles bound to the substrate with the first type of nanoparticles, the contacting  
15 taking place under conditions effective to allow hybridization of the oligonucleotides on the first and second types of nanoparticles.

32. The method of Claim 27 wherein the substrate has a plurality of types of oligonucleotides attached to it in an array to allow for the detection of multiple portions  
20 of a single nucleic acid, the detection of multiple different nucleic acids, or both.

33. The method of any one of Claims 23-32 wherein the substrate is a transparent substrate or an opaque white substrate.  
25

34. The method of Claim 33 wherein the detectable change is the formation of dark areas on the substrate.



35. The method of any one of Claims 23-32 wherein the nanoparticles are made of gold.

36. The method of any one of Claims 23-32 wherein the substrate is contacted  
5 with silver stain to produce the detectable change.

37. The method of any one of Claims 23-32 wherein the detectable change is observed with an optical scanner.

10 38. A method of detecting nucleic acid having at least two portions comprising:

contacting a nucleic acid to be detected with a substrate having oligonucleotides attached thereto, the oligonucleotides having a sequence complementary to a first portion of the sequence of said nucleic acid, the contacting taking place under  
15 conditions effective to allow hybridization of the oligonucleotides on the substrate with said nucleic acid;

contacting said nucleic acid bound to the substrate with a type of nanoparticles having oligonucleotides attached thereto, the oligonucleotides having a sequence complementary to a second portion of the sequence of said nucleic acid, the  
20 contacting taking place under conditions effective to allow hybridization of the oligonucleotides on the nanoparticles with said nucleic acid;

contacting the substrate with silver stain to produce a detectable change;  
and

observing the detectable change.

25

39. The method of Claim 38 wherein the nanoparticles are made of a noble metal.

40. The method of Claim 39 wherein the nanoparticles are made of gold or silver.

41. The method of Claim 38 wherein the substrate has a plurality of types of oligonucleotides attached to it in an array to allow for the detection of multiple portions of a single nucleic acid, the detection of multiple different nucleic acids, or both.

5

42. The method of any one of Claims 38-41 wherein the detectable change is observed with an optical scanner.

43. A method of detecting nucleic acid having at least two portions  
10 comprising:

contacting a nucleic acid to be detected with a substrate having oligonucleotides attached thereto, the oligonucleotides having a sequence complementary to a first portion of the sequence of said nucleic acid, the contacting taking place under conditions effective to allow hybridization of the oligonucleotides on the substrate with  
15 said nucleic acid;

contacting said nucleic acid bound to the substrate with liposomes having oligonucleotides attached thereto, the oligonucleotides having a sequence complementary to a portion of the sequence of said nucleic acid, the contacting taking place under conditions effective to allow hybridization of the oligonucleotides on the liposomes with  
20 said nucleic acid;

contacting the liposomes bound to the substrate with a first type of nanoparticles having at least a first type oligonucleotides attached thereto, the first type of oligonucleotides having a hydrophobic group attached to the end not attached to the nanoparticles, the contacting taking place under conditions effective to allow attachment  
25 of the oligonucleotides on the nanoparticles to the liposomes as a result of hydrophobic interactions; and

observing a detectable change.

44. A method of detecting nucleic acid having at least two portions comprising

contacting a nucleic acid to be detected with a substrate having oligonucleotides attached thereto, the oligonucleotides having a sequence complementary  
5 to a first portion of the sequence of said nucleic acid, the contacting taking place under conditions effective to allow hybridization of the oligonucleotides on the substrate with said nucleic acid;

contacting said nucleic acid bound to the substrate with liposomes having oligonucleotides attached thereto, the oligonucleotides having a sequence complementary  
10 to a portion of the sequence of said nucleic acid, the contacting taking place under conditions effective to allow hybridization of the oligonucleotides on the liposomes with said nucleic acid;

contacting the liposomes bound to the substrate with a first type of nanoparticles having at least a first type oligonucleotides attached thereto, the first type of  
15 oligonucleotides having a hydrophobic group attached to the end not attached to the nanoparticles, the contacting taking place under conditions effective to allow attachment of the oligonucleotides on the nanoparticles to the liposomes as a result of hydrophobic interactions;

contacting the first type of nanoparticles bound to the liposomes with a  
20 second type of nanoparticles having oligonucleotides attached thereto,

the first type of nanoparticles having a second type of oligonucleotides attached thereto which have a sequence complementary to at least a portion of the sequence of the oligonucleotides on the second type of nanoparticles,

the oligonucleotides on the second type of nanoparticles having a  
25 sequence complementary to at least a portion of the sequence of the second type of oligonucleotides on the first type of nanoparticles,

the contacting taking place under conditions effective to allow hybridization of the oligonucleotides on the first and second types of nanoparticles; and

observing a detectable change.

45. The method of Claim 43 or 44 wherein the substrate has a plurality of types of oligonucleotides attached to it in an array to allow for the detection of multiple  
5 portions of a single nucleic acid, the detection of multiple different nucleic acids, or both.

46. The method of Claim 43 or 44 wherein the nanoparticles are made of gold.

47. The method of Claim 43 or 44 wherein the substrate is contacted with  
10 silver stain to produce the detectable change.

48. The method of any one of Claims 43 or 44 wherein the detectable change is observed with an optical scanner.

15 49. A method of detecting nucleic acid having at least two portions comprising:

providing a substrate having a first type of nanoparticles attached thereto, the nanoparticles having oligonucleotides attached thereto, the oligonucleotides having a sequence complementary to a first portion of the sequence of a nucleic acid to be  
20 detected;

contacting said nucleic acid with the nanoparticles attached to the substrate under conditions effective to allow hybridization of the oligonucleotides on the nanoparticles with said nucleic acid;

25 providing an aggregate probe comprising at least two types of nanoparticles having oligonucleotides attached thereto, the nanoparticles of the aggregate probe being bound to each other as a result of the hybridization of some of the oligonucleotides attached to them, at least one of the types of nanoparticles of the aggregate probe having oligonucleotides attached thereto which have a sequence

complementary to a second portion of the sequence of said nucleic acid;

contacting said nucleic acid bound to the substrate with the aggregate probe under conditions effective to allow hybridization of the oligonucleotides on the aggregate probe with said nucleic acid; and

5                   observing a detectable change.

50. The method of Claim 49 wherein the substrate has a plurality of types of nanoparticles attached to it in an array to allow for the detection of multiple portions of a single nucleic acid, the detection of multiple different nucleic acids, or both.

10

51. A method of detecting nucleic acid having at least two portions comprising:

providing a substrate having oligonucleotides attached thereto, the oligonucleotides having a sequence complementary to a first portion of the sequence of a  
15                   nucleic acid to be detected;

providing an aggregate probe comprising at least two types of nanoparticles having oligonucleotides attached thereto, the nanoparticles of the aggregate probe being bound to each other as a result of the hybridization of some of the oligonucleotides attached to them, at least one of the types of nanoparticles of the  
20                   aggregate probe having oligonucleotides attached thereto which have a sequence complementary to a second portion of the sequence of said nucleic acid;

contacting said nucleic acid, the substrate and the aggregate probe under conditions effective to allow hybridization of said nucleic acid with the oligonucleotides on the aggregate probe and with the oligonucleotides on the substrate; and

25                   observing a detectable change.

52. The method of Claim 51 wherein said nucleic acid is contacted with the substrate so that said nucleic acid hybridizes with the oligonucleotides on the substrate,

and said nucleic acid bound to the substrate is then contacted with the aggregate probe so that said nucleic acid hybridizes with the oligonucleotides on the aggregate probe.

53. The method of Claim 51 wherein said nucleic acid is contacted with the  
5 aggregate probe so that said nucleic acid hybridizes with the oligonucleotides on the aggregate probe, and said nucleic acid bound to the aggregate probe is then contacted with the substrate so that said nucleic acid hybridizes with the oligonucleotides on the substrate.

10 54. The method of Claim 51 wherein said nucleic acid is contacted simultaneously with the aggregate probe and the substrate.

55. The method of Claim 51 wherein the substrate has a plurality of types of oligonucleotides attached to it in an array to allow for the detection of multiple portions  
15 of a single nucleic acid, the detection of multiple different nucleic acids, or both.

56. A method of detecting nucleic acid having at least two portions comprising:

providing a substrate having oligonucleotides attached thereto;

20 providing an aggregate probe comprising at least two types of nanoparticles having oligonucleotides attached thereto, the nanoparticles of the aggregate probe being bound to each other as a result of the hybridization of some of the oligonucleotides attached to them, at least one of the types of nanoparticles of the aggregate probe having oligonucleotides attached thereto which have a sequence  
25 complementary to a first portion of the sequence of a nucleic acid to be detected;

providing a type of nanoparticles having at least two types of oligonucleotides attached thereto, the first type of oligonucleotides having a sequence complementary to a second portion of the sequence of said nucleic acid, the second type

of oligonucleotides having a sequence complementary to at least a portion of the sequence of the oligonucleotides attached to the substrate;

contacting said nucleic acid, the aggregate probe, the nanoparticles and the substrate, the contacting taking place under conditions effective to allow hybridization of  
5 said nucleic acid with the oligonucleotides on the aggregate probe and on the nanoparticles and hybridization of the oligonucleotides on the nanoparticles with the oligonucleotides on the substrate; and  
observing a detectable change.

10 57. The method of Claim 56 wherein said nucleic acid is contacted with the aggregate probe and the nanoparticles so that said nucleic acid hybridizes with the oligonucleotides on the aggregate probe and with the oligonucleotides on the nanoparticles, and said nucleic acid bound to the aggregate probe and nanoparticles is then contacted with the substrate so that the oligonucleotides on the nanoparticles  
15 hybridize with the oligonucleotides on the substrate.

58. The method of Claim 56 wherein said nucleic acid is contacted with the aggregate probe so that said nucleic acid hybridizes with the oligonucleotides on the aggregate probe, said nucleic acid bound to the aggregate probe is then contacted with the  
20 nanoparticles so that said nucleic acid hybridizes with the oligonucleotides on the nanoparticles, and said nucleic acid bound to the aggregate probe and nanoparticles is then contacted with the substrate so that the oligonucleotides on the nanoparticles hybridize with the oligonucleotides on the substrate.

25 59. The method of Claim 56 wherein said nucleic acid is contacted with the aggregate probe so that said nucleic acid hybridizes with the oligonucleotides on the aggregate probe, the nanoparticles are contacted with the substrate so that the oligonucleotides on the nanoparticles hybridize with the oligonucleotides on the

substrate, and said nucleic acid bound to the aggregate probe is then contacted with the nanoparticles bound to the substrate so that said nucleic acid hybridizes with the oligonucleotides on the nanoparticles.

5           60. The method of Claim 56 wherein the substrate has the oligonucleotides attached to it in an array to allow for the detection of multiple portions of a single nucleic acid, the detection of multiple different nucleic acids, or both.

10           61. The method of any one of Claims 49-60 wherein the substrate is a transparent substrate or an opaque white substrate.

          62. The method of Claim 61 wherein the detectable change is the formation of dark areas on the substrate.

15           63. The method of any one of Claims 49-60 wherein the nanoparticles in the aggregate probe are made of gold.

          64. The method of any one of Claims 49-60 wherein the substrate is contacted with a silver stain to produce the detectable change.

20           65. The method of any one of Claims 49-60 wherein the detectable change is observed with an optical scanner.

25           66. A method of detecting nucleic acid having at least two portions comprising:

          contacting a nucleic acid to be detected with a substrate having oligonucleotides attached thereto, the oligonucleotides having a sequence complementary to a first portion of the sequence of said nucleic acid, the contacting taking place under



conditions effective to allow hybridization of the oligonucleotides on the substrate with said nucleic acid;

5                   contacting said nucleic acid bound to the substrate with liposomes having oligonucleotides attached thereto, the oligonucleotides having a sequence complementary to a portion of the sequence of said nucleic acid, the contacting taking place under conditions effective to allow hybridization of the oligonucleotides on the liposomes with said nucleic acid;

10                   providing an aggregate probe comprising at least two types of nanoparticles having oligonucleotides attached thereto, the nanoparticles of the aggregate probe being bound to each other as a result of the hybridization of some of the oligonucleotides attached to them, at least one of the types of nanoparticles of the aggregate probe having oligonucleotides attached thereto which have a hydrophobic group attached to the end not attached to the nanoparticles;

15                   contacting the liposomes bound to the substrate with the aggregate probe under conditions effective to allow attachment of the oligonucleotides on the aggregate probe to the liposomes as a result of hydrophobic interactions; and

observing a detectable change.

20                   67. The method of Claim 66 wherein the nanoparticles in the aggregate probe are made of gold.

68. The method of Claim 66 wherein the substrate is contacted with a silver stain to produce the detectable change.

25                   69. The method of Claim 66 wherein the substrate has a plurality of types of oligonucleotides attached to it in an array to allow for the detection of multiple portions of a single nucleic acid, the detection of multiple different nucleic acids, or both.

70. A method of detecting nucleic acid having at least two portions comprising:

providing a substrate having oligonucleotides attached thereto, the oligonucleotides having a sequence complementary to a first portion of the sequence of a nucleic acid to be detected;

5 providing a core probe comprising at least two types of nanoparticles, each type of nanoparticles having oligonucleotides attached thereto which are complementary to the oligonucleotides on at least one of the other types of nanoparticles, the nanoparticles of the aggregate probe being bound to each other as a result of the hybridization of the oligonucleotides attached to them;

10 providing a type of nanoparticles having two types of oligonucleotides attached thereto, the first type of oligonucleotides having a sequence complementary to a second portion of the sequence of said nucleic acid, the second type of oligonucleotides having a sequence complementary to a portion of the sequence of the oligonucleotides attached to at least one of the types of nanoparticles of the core probe;

15 contacting said nucleic acid, the nanoparticles, the substrate and the core probe under conditions effective to allow hybridization of said nucleic acid with the oligonucleotides on the nanoparticles and with the oligonucleotides on the substrate and to allow hybridization of the oligonucleotides on the nanoparticles with the oligonucleotides on the core probe; and

20 observing a detectable change.

71. The method of Claim 70 wherein said nucleic acid is contacted with the substrate so that said nucleic acid hybridizes with the oligonucleotides on the substrate, and said nucleic acid bound to the substrate is then contacted with the nanoparticles so that said nucleic acid hybridizes with the oligonucleotides on the nanoparticles, and the nanoparticles bound to said nucleic acid are contacted with the core probe so that the oligonucleotides on the core probe hybridize with the oligonucleotides on the

nanoparticles.

72. The method of Claim 70 wherein said nucleic acid is contacted with the nanoparticles so that said nucleic acid hybridizes with the oligonucleotides on the nanoparticles, said nucleic acid bound to the nanoparticles is then contacted with the  
5 substrate so that said nucleic acid hybridizes with the oligonucleotides on the substrate, and the nanoparticles bound to said nucleic acid are contacted with the core probe so that the oligonucleotides on the core probe hybridize with the oligonucleotides on the nanoparticles.

10 73. A method of detecting nucleic acid having at least two portions comprising:

providing a substrate having oligonucleotides attached thereto, the oligonucleotides having a sequence complementary to a first portion of the sequence of a nucleic acid to be detected;

15 providing a core probe comprising at least two types of nanoparticles, each type of nanoparticles having oligonucleotides attached thereto which are complementary to the oligonucleotides on at least one other type of nanoparticles, the nanoparticles of the aggregate probe being bound to each other as a result of the hybridization of the oligonucleotides attached to them;

20 providing a type of linking oligonucleotides comprising a sequence complementary to a second portion of the sequence of said nucleic acid and a sequence complementary to a portion of the sequence of the oligonucleotides attached to at least one of the types of nanoparticles of the core probe;

25 contacting said nucleic acid, the linking oligonucleotides, the substrate and the core probe under conditions effective to allow hybridization of said nucleic acid with the linking oligonucleotides and with the oligonucleotides on the substrate and to allow hybridization of the oligonucleotides on the linking oligonucleotides with the oligonucleotides on the core probe; and

observing a detectable change.

74. The method of any one of Claims 70-73 wherein the substrate has a plurality of types of oligonucleotides attached to it in an array to allow for the detection of multiple portions of a single nucleic acid, the detection of multiple different nucleic acids, or both.

75. The method of any one of Claims 70-73 wherein the substrate is a transparent substrate or an opaque white substrate.

76. The method of Claim 76 wherein the detectable change is the formation of dark areas on the substrate.

77. The method of any one of Claims 70-73 wherein the nanoparticles in the core probe are made of gold.

78. The method of any one of Claims 70-73 wherein the substrate is contacted with a silver stain to produce the detectable change.

79. The method of any one of Claims 70-73 wherein the detectable change is observed with an optical scanner.

80. A method of detecting a nucleic acid having at least two portions comprising:

providing nanoparticles having oligonucleotides attached thereto;  
providing one or more types of binding oligonucleotides, each of the binding oligonucleotides having two portions, the sequence of one portion being complementary to the sequence of one of the portions of the nucleic acid and the

sequence of the other portion being complementary to the sequence of the oligonucleotides on the nanoparticles;

contacting the nanoparticles and the binding oligonucleotides under conditions effective to allow hybridization of the oligonucleotides on the nanoparticles with the binding oligonucleotides;

contacting the nucleic acid and the binding oligonucleotides under conditions effective to allow hybridization of the binding oligonucleotides with the nucleic acid; and

observing a detectable change.

10

81. The method of Claim 80 wherein the nanoparticles are contacted with the binding oligonucleotides prior to being contacted with the nucleic acid.

82. A method of detecting a nucleic acid having at least two portions comprising:

15

providing nanoparticles having oligonucleotides attached thereto;

providing one or more binding oligonucleotides, each of the binding oligonucleotides having two portions, the sequence of one portion being complementary to the sequence of at least two portions of the nucleic acid and the sequence of the other portion being complementary to the sequence of the oligonucleotides on the nanoparticles;

20

contacting the nanoparticles and the binding oligonucleotides under conditions effective to allow hybridization of the oligonucleotides on the nanoparticles with the binding oligonucleotides;

25

contacting the nucleic acid and the binding oligonucleotides under conditions effective to allow hybridization of the binding oligonucleotides with the nucleic acid; and

observing a detectable change.

83. A method of detecting nucleic acid having at least two portions comprising:

5 contacting the nucleic acid with at least two types of particles having oligonucleotides attached thereto,

the oligonucleotides on the first type of particles having a sequence complementary to a first portion of the sequence of the nucleic acid and being labeled with an energy donor,

10 the oligonucleotides on the second type of particles having a sequence complementary to a second portion of the sequence of the nucleic acid and being labeled with an energy acceptor,

the contacting taking place under conditions effective to allow hybridization of the oligonucleotides on the particles with the nucleic acid; and

15 observing a detectable change brought about by hybridization of the oligonucleotides on the particles with the nucleic acid.

84. The method of Claim 83 wherein the energy donor and acceptor are fluorescent molecules.

20 85. A method of detecting nucleic acid having at least two portions comprising:

providing a type of microspheres having oligonucleotides attached thereto, the oligonucleotides having a sequence complementary to a first portion of the sequence of the nucleic acid and being labeled with a fluorescent molecule;

25 providing a type of nanoparticles having oligonucleotides attached thereto, the oligonucleotides having a sequence complementary to a second portion of the sequence of the nucleic acid, nanoparticles being capable of producing a detectable change;

contacting the nucleic acid with the microspheres and the nanoparticles under conditions effective to allow hybridization of the oligonucleotides on the microspheres and on the nanoparticles with the nucleic acid; and

5 observing a change in fluorescence, another detectable change produced by the nanoparticles, or both.

86. The method of Claim 85 wherein the detectable change produced by the nanoparticles is a change in color.

10 87. The method of Claim 85 wherein the microspheres are latex microspheres and the nanoparticles are gold nanoparticles, and changes in fluorescence, color or both are observed.

15 88. The method of Claim 87 further comprising placing a portion of the mixture of the latex microspheres, nanoparticles and nucleic acid in an observation area located on a microporous material, treating the microporous material so as to remove any unbound gold nanoparticles from the observation area, and then observing the changes in fluorescence, color, or both.

20 89. A method of detecting nucleic acid having at least two portions comprising:

25 providing a first type of metallic or semiconductor nanoparticles having oligonucleotides attached thereto, the oligonucleotides having a sequence complementary to a first portion of the sequence of the nucleic acid and being labeled with a fluorescent molecule;

providing a second type of metallic or semiconductor nanoparticles having oligonucleotides attached thereto, the oligonucleotides having a sequence complementary to a second portion of the sequence of the nucleic acid and being labeled with a

fluorescent molecule;

contacting the nucleic acid with the two types of nanoparticles under conditions effective to allow hybridization of the oligonucleotides on the two types of nanoparticles with the nucleic acid; and

5                   observing changes in fluorescence.

90.   The method of Claim 89 further comprising placing a portion of the mixture of the nanoparticles and nucleic acid in an observation area located on a microporous material, treating the microporous material so as to remove any unbound  
10 nanoparticles from the observation area, and then observing the changes in fluorescence.

91.   A method of detecting nucleic acid having at least two portions comprising:

                  providing a type of particle having oligonucleotides attached thereto, the  
15 oligonucleotides having a first portion and a second portion, both portions being complementary to portions of the sequence of the nucleic acid;

                  providing a type of probe oligonucleotides comprising a first portion and a second portion, the first portion having a sequence complementary to the first portion of the oligonucleotides attached to the particles and both portions being complementary to  
20 portions of the sequence of the nucleic acid, the probe oligonucleotides further being labeled with a reporter molecule at one end;

                  contacting the particle and the probe oligonucleotides under conditions effective to allow for hybridization of the oligonucleotides on the particles with the probe oligonucleotides to produce a satellite probe;

25                   then contacting the satellite probe with the nucleic acid under conditions effective to provide for hybridization of the nucleic acid with the probe oligonucleotides;

                  removing the particles; and

                  detecting the reporter molecule.



92. The method of Claim 91 wherein the particles are magnetic and the reporter molecule is a fluorescent molecule.

5 93. The method of Claim 91 wherein the particles are magnetic and the reporter molecule is a dye molecule.

94. The method of Claim 91 wherein the particles are magnetic and the reporter molecule is a redox-active molecule.

10

95. A kit comprising at least one container, the container holding a composition comprising at least two types of nanoparticles having oligonucleotides attached thereto, the oligonucleotides on the first type of nanoparticles having a sequence complementary to the sequence of a first portion of a nucleic acid, the oligonucleotides  
15 on the second type of nanoparticles having a sequence complementary to the sequence of a second portion of the nucleic acid.

96. The kit of Claim 95 wherein the composition in the container further comprises a filler oligonucleotide having a sequence complementary to a third portion of  
20 the nucleic acid, the third portion being located between the first and second portions.

97. The kit of Claim 95 wherein the nanoparticles are made of gold.

98. The kit of Claim 95 further comprising a solid surface.

25

99. A kit comprising at least two containers,  
the first container holding nanoparticles having oligonucleotides attached thereto which have a sequence complementary to the sequence of a first portion of a

nucleic acid, and

the second container holding nanoparticles having oligonucleotides attached thereto which have a sequence complementary to the sequence of a second portion of the nucleic acid.

5

100. The kit of Claim 99 comprising a third container holding oligonucleotides having a sequence complementary to a third portion of the nucleic acid, the third portion being located between the first and second portions.

10

101. The kit of Claim 99 wherein the nanoparticles are made of gold.

102. The kit of Claim 99 further comprising a solid surface.

15

103. A kit comprising at least two containers,  
the first container holding nanoparticles having oligonucleotides attached thereto which have a sequence complementary to the sequence of a first portion of a binding oligonucleotide, and

20

the second container holding one or more types of binding oligonucleotides, each of which has a sequence comprising at least two portions, the first portion being complementary to the sequence of the oligonucleotides on the nanoparticles and the second portion being complementary to the sequence of a portion of a nucleic acid.

25

104. The kit of Claim 103 which comprises additional containers, each holding an additional binding oligonucleotide, each additional binding oligonucleotide having a sequence comprising at least two portions, the first portion being complementary to the sequence of the oligonucleotides on the nanoparticles and the second portion being complementary to the sequence of another portion of the nucleic acid.

105. The kit of Claim 103 wherein the nanoparticles are made of gold.

106. The kit of Claim 103 further comprising a solid surface.

5

107. A kit comprising:

a container holding one type of nanoparticles having oligonucleotides attached thereto and one or more types of binding oligonucleotides, each of the types of binding oligonucleotides having a sequence comprising at least two portions, the first  
10 portion being complementary to the sequence of the oligonucleotides on the nanoparticles, whereby the binding oligonucleotides are hybridized to the oligonucleotides on the nanoparticles, and the second portion being complementary to the sequence of one or more portions of a nucleic acid.

15

108. A kit comprising at least one container, the container holding metallic or semiconductor nanoparticles having oligonucleotides attached thereto, the oligonucleotides having a sequence complementary to a portion of a nucleic acid and having fluorescent molecules attached to the ends of the oligonucleotides not attached to the nanoparticles.

20

109. A kit comprising:

a substrate, the substrate having attached thereto nanoparticles, the nanoparticles having oligonucleotides attached thereto which have a sequence complementary to the sequence of a first portion of a nucleic acid; and

25

a first container holding nanoparticles having oligonucleotides attached thereto which have a sequence complementary to the sequence of a second portion of the nucleic acid.

110. The kit of Claim 109 further comprising:

a second container holding a binding oligonucleotide having a selected sequence having at least two portions, the first portion being complementary to at least a portion of the sequence of the oligonucleotides on the nanoparticles in the first container;

5 and

a third container holding nanoparticles having oligonucleotides attached thereto, the oligonucleotides having a sequence complementary to the sequence of a second portion of the binding oligonucleotide.

111. A kit comprising at least three containers:

the first container holding nanoparticles;

the second container holding a first oligonucleotide having a sequence complementary to the sequence of a first portion of a nucleic acid; and

15 the third container holding a second oligonucleotide having a sequence complementary to the sequence of a second portion of the nucleic acid.

112. The kit of Claim 111 further comprising a fourth container holding a third oligonucleotide having a sequence complementary to the sequence of a third portion of the nucleic acid, the third portion being located between the first and second portions.

20

113. The kit of Claim 111 further comprising a substrate.

114. The kit of Claim 113 further comprising:

25 a fourth container holding a binding oligonucleotide having a selected sequence having at least two portions, the first portion being complementary to at least a portion of the sequence of the second oligonucleotide; and

a fifth container holding an oligonucleotide having a sequence complementary to the sequence of a second portion of the binding oligonucleotide.

115. The kit of Claim 111 wherein the oligonucleotides, nanoparticles, or both bear functional groups for attachment of the oligonucleotides to the nanoparticles.

5 116. The kit of Claim 113 wherein the substrate, nanoparticles, or both bear functional groups for attachment of the nanoparticles to the substrate.

117. The kit of Claim 113 wherein the substrate has nanoparticles attached to it.

10 118. The kit of Claim 111 wherein the nanoparticles are made of gold.

119. A kit comprising:

a substrate having oligonucleotides attached thereto which have a sequence complementary to the sequence of a first portion of a nucleic acid;

15 a first container holding nanoparticles having oligonucleotides attached thereto, some of which have a sequence complementary to the sequence of a second portion of the nucleic acid; and

a second container holding nanoparticles having oligonucleotides attached thereto which have a sequence complementary to at least a portion of the sequence of the oligonucleotides attached to the nanoparticles in the first container.

20

120. A kit comprising:

a substrate;

a first container holding nanoparticles;

25 a second container holding a first oligonucleotide having a sequence complementary to the sequence of a first portion of a nucleic acid;

a third container holding a second oligonucleotide having a sequence complementary to the sequence of a second portion of the nucleic acid; and

a fourth container holding a third oligonucleotide having a sequence complementary to at least a portion of the sequence of the second oligonucleotide.

121. The kit of Claim 120 wherein the oligonucleotides, nanoparticles, substrate or all bear functional groups for attachment of the oligonucleotides to the nanoparticles or for attachment of the oligonucleotides to the substrate.

122. The kit of Claim 120 wherein the nanoparticles are made of gold.

10 123. A kit comprising:

a substrate having oligonucleotides attached thereto which have a sequence complementary to the sequence of a first portion of a nucleic acid;

a first container holding liposomes having oligonucleotides attached thereto which have a sequence complementary to the sequence of a second portion of the nucleic acid; and

a second container holding nanoparticles having at least a first type of oligonucleotides attached thereto, the first type of oligonucleotides having a hydrophobic group attached to the end not attached to the nanoparticles.

20 124. The kit of Claim 123 wherein:

the nanoparticles in the second container have a second type of oligonucleotides attached thereto, the second type of oligonucleotides having a sequence complementary to the sequence of the oligonucleotides on a second type of nanoparticles;

and the kit further comprises:

25 a third container holding a second type of nanoparticles having oligonucleotides attached thereto, the oligonucleotides having a sequence complementary to at least a portion of the sequence of the second type of oligonucleotides on the first type of nanoparticles.

125. A kit comprising:

a substrate, the substrate having attached thereto nanoparticles, the nanoparticles having oligonucleotides attached thereto which have a sequence  
5 complementary to the sequence of a first portion of a nucleic acid; and

a first container holding an aggregate probe comprising at least two types  
of nanoparticles having oligonucleotides attached thereto, the nanoparticles of the  
aggregate probe being bound to each other as a result of the hybridization of some of the  
oligonucleotides attached to them, at least one of the types of nanoparticles of the  
10 aggregate probe having oligonucleotides attached thereto which have a sequence  
complementary to a second portion of the sequence of the nucleic acid.

126. A kit comprising:

a substrate, the substrate having oligonucleotides attached thereto, the  
15 oligonucleotides having a sequence complementary to the sequence of a first portion of a  
nucleic acid; and

a first container holding an aggregate probe comprising at least two types  
of nanoparticles having oligonucleotides attached thereto, the nanoparticles of the  
aggregate probe being bound to each other as a result of the hybridization of some of the  
oligonucleotides attached to them, at least one of the types of nanoparticles of the  
20 aggregate probe having oligonucleotides attached thereto which have a sequence  
complementary to a second portion of the sequence of the nucleic acid.

127. The kit of Claim 126 wherein the substrate has a plurality of types of  
25 oligonucleotides attached to it in an array to allow for the detection of multiple portions  
of a single nucleic acid, the detection of multiple different nucleic acids, or both.

128. A kit comprising:

a substrate having oligonucleotides attached thereto;

a first container holding an aggregate probe comprising at least two types of nanoparticles having oligonucleotides attached thereto, the nanoparticles of the aggregate probe being bound to each other as a result of the hybridization of some of the oligonucleotides attached to them, at least one of the types of nanoparticles of the aggregate probe having oligonucleotides attached thereto which have a sequence complementary to a first portion of the sequence of the nucleic acid; and

a second container holding nanoparticles having at least two types of oligonucleotides attached thereto, the first type of oligonucleotides having a sequence complementary to a second portion of the sequence of the nucleic acid, and the second type of oligonucleotides having a sequence complementary to at least a portion of the sequence of the oligonucleotides attached to the substrate.

129. A kit comprising:

a substrate, the substrate having oligonucleotides attached thereto, the oligonucleotides having a sequence complementary to the sequence of a first portion of a nucleic acid;

a first container holding liposomes having oligonucleotides attached thereto which have a sequence complementary to the sequence of a second portion of the nucleic acid; and

a second container holding an aggregate probe comprising at least two types of nanoparticles having oligonucleotides attached thereto, the nanoparticles of the aggregate probe being bound to each other as a result of the hybridization of some of the oligonucleotides attached to them, at least one of the types of nanoparticles of the aggregate probe having oligonucleotides attached thereto which have a hydrophobic group attached to the end not attached to the nanoparticles.

130. The kit of any one of Claims 125-129 wherein the substrate is a



transparent substrate or an opaque white substrate.

131. The kit of any one of Claims 125-129 wherein the nanoparticles of the aggregate probe are made of gold.

5

132. A kit comprising at least three containers:

the first container holding nanoparticles;

the second container holding a first oligonucleotide having a sequence complementary to the sequence of a first portion of a nucleic acid; and

10

the third container holding a second oligonucleotide having a sequence complementary to the sequence of a second portion of the nucleic acid.

133. The kit of Claim 132 further comprising a fourth container holding a third oligonucleotide having a sequence complementary to the sequence of a third portion of the nucleic acid, the third portion being located between the first and second portions.

15

134. The kit of Claim 132 further comprising a substrate.

135. The kit of Claim 134 further comprising:

20

a fourth container holding a binding oligonucleotide having a selected sequence having at least two portions, the first portion being complementary to at least a portion of the sequence of the second oligonucleotide; and

a fifth container holding an oligonucleotide having a sequence complementary to the sequence of a second portion of the binding oligonucleotide.

25

136. The kit of Claim 132 wherein the oligonucleotides, nanoparticles, or both bear functional groups for attachment of the oligonucleotides to the nanoparticles.

137. The kit of Claim 134 wherein the substrate, nanoparticles, or both bear functional groups for attachment of the nanoparticles to the substrate.

138. The kit of Claim 134 wherein the substrate has nanoparticles attached to it.

5

139. The kit of Claim 132 wherein the nanoparticles are made of gold.

140. A kit comprising:

10 a substrate having oligonucleotides attached thereto which have a sequence complementary to the sequence of a first portion of a nucleic acid;

a first container holding nanoparticles having oligonucleotides attached thereto, some of which have a sequence complementary to the sequence of a second portion of the nucleic acid; and

15 a second container holding nanoparticles having oligonucleotides attached thereto which have a sequence complementary to at least a portion of the sequence of the oligonucleotides attached to the nanoparticles in the first container.

141. A kit comprising:

a substrate;

20

a first container holding nanoparticles;

a second container holding a first oligonucleotide having a sequence complementary to the sequence of a first portion of a nucleic acid;

a third container holding a second oligonucleotide having a sequence complementary to the sequence of a second portion of the nucleic acid; and

25

a fourth container holding a third oligonucleotide having a sequence complementary to at least a portion of the sequence of the second oligonucleotide.

142. The kit of Claim 141 wherein the oligonucleotides, nanoparticles,

substrate or all bear functional groups for attachment of the oligonucleotides to the nanoparticles or for attachment of the oligonucleotides to the substrate.

143. The kit of Claim 141 wherein the nanoparticles are made of gold.

5

144. A kit comprising:

a substrate having oligonucleotides attached thereto which have a sequence complementary to the sequence of a first portion of a nucleic acid;

10 a first container holding liposomes having oligonucleotides attached thereto which have a sequence complementary to the sequence of a second portion of the nucleic acid; and

a second container holding nanoparticles having at least a first type of oligonucleotides attached thereto, the first type of oligonucleotides having a hydrophobic group attached to the end not attached to the nanoparticles.

15

145. The kit of Claim 144 wherein:

the nanoparticles in the second container have a second type of oligonucleotides attached thereto, the second type of oligonucleotides having a sequence complementary to the sequence of the oligonucleotides on a second type of nanoparticles;

20

and the kit further comprises:

a third container holding a second type of nanoparticles having oligonucleotides attached thereto, the oligonucleotides having a sequence complementary to at least a portion of the sequence of the second type of oligonucleotides on the first type of nanoparticles.

25

146. A kit comprising at least two containers,

the first container holding particles having oligonucleotides attached thereto which have a sequence complementary to the sequence of a first portion of a

nucleic acid, the oligonucleotides being labeled with an energy donor on the ends not attached to the particles,

the second container holding particles having oligonucleotides attached thereto which have a sequence complementary to the sequence of a second portion of a nucleic acid, the oligonucleotides being labeled with an energy acceptor on the ends not attached to the particles.

147. The kit of Claim 146 wherein the energy donor and acceptor are fluorescent molecules.

10

148. A kit comprising at least one container, the container holding a first type of particles having oligonucleotides attached thereto which have a sequence complementary to the sequence of a first portion of a nucleic acid, the oligonucleotides being labeled with an energy donor on the ends not attached to the particles; and a second type of particles having oligonucleotides attached thereto which have a sequence complementary to the sequence of a second portion of a nucleic acid, the oligonucleotides being labeled with an energy acceptor on the ends not attached to the particles.

149. The kit of Claim 148 wherein the energy donor and acceptor are fluorescent molecules.

20

150. A kit comprising:

a first container holding a type of microspheres having oligonucleotides attached thereto, the oligonucleotides having a sequence complementary to a first portion of the sequence of a nucleic acid and being labeled with a fluorescent molecule; and

25

a second container holding a type of nanoparticles having oligonucleotides attached thereto, the oligonucleotides having a sequence complementary to a second portion of the sequence of the nucleic acid.

151. The kit of Claim 150 wherein the microspheres are latex microspheres and the nanoparticles are gold nanoparticles.

5           152. The kit of Claim 150 further comprising a microporous material.

153. A kit comprising:

          a first container holding a first type of metallic or semiconductor nanoparticles having oligonucleotides attached thereto, the oligonucleotides having a  
10 sequence complementary to a first portion of the sequence of a nucleic acid and being labeled with a fluorescent molecule; and

          a second container holding a second type of metallic or semiconductor nanoparticles having oligonucleotides attached thereto, the oligonucleotides having a  
15 sequence complementary to a second portion of the sequence of a nucleic acid and being labeled with a fluorescent molecule.

154. The kit of Claim 153 further comprising a microporous material.

155. A kit comprising a container holding a satellite probe, the satellite probe  
20 comprising:

          a particle having attached thereto oligonucleotides, the oligonucleotides having a first portion and a second portion, both portions having sequences complementary to portions of the sequence of a nucleic acid; and

          probe oligonucleotides hybridized to the oligonucleotides attached to the  
25 nanoparticles, the probe oligonucleotides having a first portion and a second portion, the first portion having a sequence complementary to the sequence of the first portion of the oligonucleotides attached to the particles, both portions having sequences complementary to portions of the sequence of the nucleic acid, the probe oligonucleotides further having

a reporter molecule attached to one end.

156. A kit comprising a container holding an aggregate probe, the aggregate probe comprising at least two types of nanoparticles having oligonucleotides attached thereto, the nanoparticles of the aggregate probe being bound to each other as a result of the hybridization of some of the oligonucleotides attached to them, at least one of the types of nanoparticles of the aggregate probe having oligonucleotides attached thereto which have a sequence complementary to a portion of the sequence of a nucleic acid.

157. A kit comprising a container holding an aggregate probe, the aggregate probe comprising at least two types of nanoparticles having oligonucleotides attached thereto, the nanoparticles of the aggregate probe being bound to each other as a result of the hybridization of some of the oligonucleotides attached to them, at least one of the types of nanoparticles of the aggregate probe having oligonucleotides attached thereto which have a hydrophobic group attached to the end not attached to the nanoparticles.

158. An aggregate probe, the aggregate probe comprising at least two types of nanoparticles having oligonucleotides attached thereto, the nanoparticles of the aggregate probe being bound to each other as a result of the hybridization of some of the oligonucleotides attached to them, at least one of the types of nanoparticles of the aggregate probe having oligonucleotides attached thereto which have a sequence complementary to a portion of the sequence of a nucleic acid.

159. The aggregate probe of Claim 158 comprising two types of nanoparticles each having two types of oligonucleotides attached thereto, the first type of oligonucleotides attached to each type of nanoparticles having a sequence complementary to a portion of the sequence of a nucleic acid, the second type of oligonucleotides attached to the first type of nanoparticles having a sequence complementary to at least a

portion of the sequence of the second type of oligonucleotides attached to the second type of nanoparticles.

160. The aggregate probe of Claim 158 comprising three types of nanoparticles  
5 having oligonucleotides attached thereto, the oligonucleotides attached to the first type of nanoparticles having a sequence complementary to at least a portion of the sequence of the oligonucleotides attached to the second type of nanoparticles, the oligonucleotides attached to the second type of nanoparticles having a sequence complementary to at least a portion of the sequence of the oligonucleotides attached to the first type of  
10 nanoparticles, and the third type of nanoparticles having two types of oligonucleotides attached thereto, the first type of oligonucleotides having a sequence complementary to a portion of the sequence of a nucleic acid, and the second type of oligonucleotides having a sequence complementary to at least a portion of the sequence of the oligonucleotides attached to the first or second type of nanoparticles.

15

161. An aggregate probe, the aggregate probe comprising at least two types of nanoparticles having oligonucleotides attached thereto, the nanoparticles of the aggregate probe being bound to each other as a result of the hybridization of some of the oligonucleotides attached to them, at least one of the types of nanoparticles of the  
20 aggregate probe having oligonucleotides attached thereto which have a hydrophobic group attached to the end not attached to the nanoparticles.

162. A kit comprising a container holding a core probe, the core probe comprising at least two types of nanoparticles having oligonucleotides attached thereto,  
25 the nanoparticles of the core probe being bound to each other as a result of the hybridization of some of the oligonucleotides attached to them.

163. The kit of Claim 162 further comprising a substrate having oligonucleotides

attached thereto, the oligonucleotides having a sequence complementary to a first portion of the sequence of a nucleic acid to be detected.

5 164. The kit of Claim 162 or 163 further comprising a container holding a type of nanoparticles having two types of oligonucleotides attached thereto, the first type of oligonucleotides having a sequence complementary to a second portion of the nucleic acid, and the second type of oligonucleotides having sequence complementary to a portion of the sequence of the oligonucleotides attached to at least one of the types of nanoparticles of the core probe.

10

165. The kit of Claim 162 or 163 further comprising a container holding a type of linking oligonucleotides comprising a sequence complementary to a second portion of the sequence of the nucleic acid and a sequence complementary to a portion of the sequence of the oligonucleotides attached to at least one of the types of nanoparticles of  
15 the core probe.

20

166. A core probe comprising at least two types of nanoparticles having oligonucleotides attached thereto, the nanoparticles of the core probe being bound to each other as a result of the hybridization of some of the oligonucleotides attached to them.

25

167. A substrate having nanoparticles attached thereto.

168. The substrate of Claim 167 wherein the nanoparticles have oligonucleotides attached thereto which have a sequence complementary to the sequence  
of a first portion of a nucleic acid.

169. A metallic or semiconductor nanoparticle having oligonucleotides attached thereto, the oligonucleotides being labeled with fluorescent molecules at the



ends not attached to the nanoparticle.

170. A satellite probe comprising:

5 a particle having attached thereto oligonucleotides, the oligonucleotides having a first portion and a second portion, both portions having sequences complementary to portions of the sequence of a nucleic acid; and

10 probe oligonucleotides hybridized to the oligonucleotides attached to the nanoparticles, the probe oligonucleotides having a first portion and a second portion, the first portion having a sequence complementary to the sequence of the first portion of the oligonucleotides attached to the particles, both portions having sequences complementary to portions of the sequence of the nucleic acid, the probe oligonucleotides further having a reporter molecule attached to one end.

171. A method of nanofabrication comprising

15 providing at least one type of linking oligonucleotide having a selected sequence, the sequence of each type of linking oligonucleotide having at least two portions;

20 providing one or more types of nanoparticles having oligonucleotides attached thereto, the oligonucleotides on each of the types of nanoparticles having a sequence complementary to the sequence of a portion of a linking oligonucleotide; and

contacting the linking oligonucleotides and nanoparticles under conditions effective to allow hybridization of the oligonucleotides on the nanoparticles to the linking oligonucleotides so that a desired nanomaterial or nanostructure is formed wherein the nanoparticles are held together by oligonucleotide connectors.

25

172. The method of Claim 171 wherein at least two types of nanoparticles having oligonucleotides attached thereto are provided, the oligonucleotides on the first type of nanoparticles having a sequence complementary to a first portion of the sequence

of a linking oligonucleotide, and the oligonucleotides on the second type of nanoparticles having a sequence complementary to a second portion of the sequence of the linking oligonucleotide.

5           173. The method of Claim 171 or 172 wherein the nanoparticles are metallic nanoparticles, semiconductor nanoparticles, or a combination thereof.

174. The method of Claim 173 wherein the metallic nanoparticles are made of gold, and the semiconductor nanoparticles are made of CdSe/ZnS (core/shell).

10

175. A method of nanofabrication comprising:  
providing at least two types of nanoparticles having oligonucleotides attached thereto,

15           the oligonucleotides on the first type of nanoparticles having a sequence complementary to that of the oligonucleotides on the second of the nanoparticles;

          the oligonucleotides on the second type of nanoparticles having a sequence complementary to that of the oligonucleotides on the first type of nanoparticles; and

20           contacting the first and second types of nanoparticles under conditions effective to allow hybridization of the oligonucleotides on the nanoparticles to each other so that a desired nanomaterial or nanostructure is formed.

176. The method of Claim 175 wherein the nanoparticles are metallic nanoparticles, semiconductor nanoparticles, or a combination thereof.

25

177. The method of Claim 176 wherein the metallic nanoparticles are made of gold, and the semiconductor nanoparticles are made of CdSe/ZnS (core/shell).

178. Nanomaterials or nanostructures composed of nanoparticles having oligonucleotides attached thereto, the nanoparticles being held together by oligonucleotide connectors.

5           179. The nanomaterials or nanostructures of Claim 178 wherein at least some of the oligonucleotide connectors are triple-stranded.

180. The nanomaterials or nanostructures of Claim 178 wherein the nanoparticles are metallic nanoparticles, semiconductor nanoparticles, or a combination  
10 thereof.

181. The nanomaterials or nanostructures of Claim 180 wherein the metallic nanoparticles are made of gold, and the semiconductor nanoparticles are made of CdSe/ZnS (core/shell).

15

182. A composition comprising at least two types of nanoparticles having oligonucleotides attached thereto, the oligonucleotides on the first type of nanoparticles having a sequence complementary to the sequence of a first portion of a nucleic acid or a linking oligonucleotide, the oligonucleotides on the second type of nanoparticles having a  
20 sequence complementary to the sequence of a second portion of the nucleic acid or linking oligonucleotide.

183. The composition of Claim 182 wherein the nanoparticles are metallic nanoparticles, semiconductor nanoparticles, or a combination thereof.

25

184. The composition of Claim 183 wherein the metallic nanoparticles are made of gold, and the semiconductor nanoparticles are made of CdSe/ZnS (core/shell).

185. An assembly of containers comprising:  
a first container holding nanoparticles having oligonucleotides attached thereto, and  
a second container holding nanoparticles having oligonucleotides attached thereto,  
5 the oligonucleotides attached to the nanoparticles in the first container having a sequence complementary to that of the oligonucleotides attached to the nanoparticles in the second container,  
the oligonucleotides attached to the nanoparticles in the second container  
10 having a sequence complementary to that of the oligonucleotides attached to the nanoparticles in the second container.

186. The assembly of Claim 185 wherein the nanoparticles are metallic nanoparticles, semiconductor nanoparticles, or a combination thereof.

15

187. The assembly of Claim 186 wherein the metallic nanoparticles are made of gold, and the semiconductor nanoparticles are made of CdSe/ZnS (core/shell).

188. A nanoparticle having a plurality of different oligonucleotides attached thereto.

20

189. A method of separating a selected nucleic acid having at least two portions from other nucleic acids, the method comprising:  
providing two or more types of nanoparticles having oligonucleotides  
25 attached thereto, the oligonucleotides on each of the types of nanoparticles having a sequence complementary to the sequence of one of the portions of the selected nucleic acid; and

contacting the nucleic acids and nanoparticles under conditions effective

to allow hybridization of the oligonucleotides on the nanoparticles with the selected nucleic acid so that the nanoparticles hybridized to the selected nucleic acid aggregate and precipitate.

5           190. A method of binding oligonucleotides to charged nanoparticles to produce stable nanoparticle-oligonucleotide conjugates, the method comprising:

          providing oligonucleotides having covalently bound thereto a moiety comprising a functional group which can bind to the nanoparticles;

          contacting the oligonucleotides and the nanoparticles in water for a period  
10 of time sufficient to allow at least some of the oligonucleotides to bind to the nanoparticles;

          adding at least one salt to the water to form a salt solution, the ionic strength of the salt solution being sufficient to overcome at least partially the electrostatic attraction or repulsion of the oligonucleotides for the nanoparticles and the electrostatic  
15 repulsion of the oligonucleotides for each other; and

          contacting the oligonucleotides and nanoparticles in the salt solution for an additional period of time sufficient to allow sufficient additional oligonucleotides to bind to the nanoparticles to produce the stable nanoparticle-oligonucleotide conjugates.

20           191. The method of Claim 190 wherein the nanoparticles are metal nanoparticles or semiconductor nanoparticles.

          192. The method of Claim 191 wherein the nanoparticles are gold nanoparticles.

25

          193. The method of Claim 192 wherein the moiety comprising a functional group which can bind to the nanoparticles is an alkanethiol.

194. The method of Claim 190 wherein all of the salt is added to the water in a single addition.

195. The method of Claim 190 wherein the salt is added gradually over time.

5

196. The method of Claim 190 wherein the salt is selected from the group consisting of sodium chloride, magnesium chloride, potassium chloride, ammonium chloride, sodium acetate, ammonium acetate, a combination of two or more of these salts, one of these salts in a phosphate buffer, and a combination of two or more these salts in a phosphate buffer.

10

197. The method of Claim 196 wherein the salt is sodium chloride in a phosphate buffer.

15

198. The method of Claim 190 wherein nanoparticle-oligonucleotide conjugates are produced which have the oligonucleotides present on surface of the nanoparticles at a surface density of at least 10 picomoles/cm<sup>2</sup>.

20

199. The method of Claim 198 wherein the oligonucleotides are present on surface of the nanoparticles at a surface density of at least 15 picomoles/cm<sup>2</sup>.

200. The method of Claim 199 wherein the oligonucleotides are present on surface of the nanoparticles at a surface density of from about 15 picomoles/cm<sup>2</sup> to about 40 picomoles/cm<sup>2</sup>.

25

201. A method of binding oligonucleotides to nanoparticles to produce nanoparticle-oligonucleotide conjugates, the method comprising:

providing oligonucleotides, the oligonucleotides comprising at least one

type of recognition oligonucleotides, each of the recognition oligonucleotides comprising a spacer portion and a recognition portion, the spacer portion being designed so that it can bind to the nanoparticles; and

5 contacting the oligonucleotides and the nanoparticles under conditions effective to allow at least some of the recognition oligonucleotides to bind to the nanoparticles to produce the nanoparticle-oligonucleotide conjugates.

202. The method of Claim 201 wherein each of the spacer portions of the recognition oligonucleotides has a moiety covalently bound thereto, the moiety  
10 comprising a functional group which can bind to the nanoparticles.

203. The method of Claim 201 wherein the nanoparticles are metal nanoparticles or semiconductor nanoparticles.

15 204. The method of Claim 203 wherein the nanoparticles are gold nanoparticles.

205. The method of Claim 204 wherein the spacer portion comprises at least about 10 nucleotides.  
20

206. The method of Claim 205 wherein the spacer portion comprises from about 10 to about 30 nucleotides.

207. The method of Claim 206 wherein the bases of the nucleotides of the  
25 spacer are all adenines, all thymines, all cytosines, all uracils, or all guanines.

208. A method of binding oligonucleotides to nanoparticles to produce nanoparticle-oligonucleotide conjugates, the method comprising:

providing oligonucleotides, the oligonucleotides comprising:

a type of recognition oligonucleotides; and

a type of diluent oligonucleotides;

contacting the oligonucleotides with the nanoparticles under conditions  
5 effective to allow at least some of each of the types of oligonucleotides to bind to the  
nanoparticles to produce the nanoparticle-oligonucleotide conjugates.

209. The method of Claim 208 wherein the nanoparticles are metal  
nanoparticles or semiconductor nanoparticles.

10

210. The method of Claim 209 wherein the nanoparticles are gold  
nanoparticles.

211. The method of Claim 208 wherein each of the recognition  
15 oligonucleotides comprises a spacer portion and a recognition portion, the spacer portion  
being designed so that it can bind to the nanoparticles.

212. The method of Claim 211 wherein each of the spacer portions of the  
recognition oligonucleotides has a moiety covalently bound thereto, the moiety  
20 comprising a functional group which can bind to the nanoparticles.

213. The method of Claim 211 wherein the spacer portions of the recognition  
oligonucleotides comprises at least about 10 nucleotides.

25 214. The method of Claim 213 wherein the spacer portions of the recognition  
oligonucleotides comprises from about 10 nucleotides to about 30 nucleotides.

215. The method of Claim 211 wherein the bases of the nucleotides of the



spacer are all adenines, all thymines, all cytosines, all uracils or all guanines.

216. The method of Claim 211 wherein the diluent oligonucleotides contain about the same number of nucleotides as are contained in the spacer portions of the recognition oligonucleotides.

217. The method of Claim 216 wherein the sequence of the diluent oligonucleotides is the same as the sequence of the spacer portions of the recognition oligonucleotides.

10

218. The method of Claim 208 wherein the oligonucleotides comprise at least two types of recognition oligonucleotides.

219. A method of binding oligonucleotides to charged nanoparticles to produce nanoparticle-oligonucleotide conjugates, the method comprising:

15

providing oligonucleotides having covalently bound thereto a moiety comprising a functional group which can bind to the nanoparticles, the oligonucleotides comprising:

20

a type of recognition oligonucleotides; and

a type of diluent oligonucleotides;

contacting the oligonucleotides with the nanoparticles in water for a period of time sufficient to allow at least some of each of the types of oligonucleotides to bind to the nanoparticles;

25 adding at least one salt to the water to form a salt solution, the ionic strength of the salt solution being sufficient to overcome at least partially the electrostatic attraction or repulsion of the oligonucleotides for the nanoparticles and the electrostatic repulsion of the oligonucleotides for each other; and

contacting the oligonucleotides and nanoparticles in the salt solution for an

additional period of time sufficient to allow additional oligonucleotides of each of the types of oligonucleotides to bind to the nanoparticles to produce the nanoparticle-oligonucleotide conjugates.

5           220. The method of Claim 219 wherein the nanoparticles are metal nanoparticles or semiconductor nanoparticles.

          221. The method of Claim 220 wherein the nanoparticles are gold nanoparticles.

10           222. The method of Claim 221 wherein the moiety comprising a functional group which can bind to the nanoparticles is an alkanethiol.

          223. The method of Claim 219 wherein all of the salt is added to the water in a  
15 single addition.

          224. The method of Claim 219 wherein the salt is added gradually over time.

          225. The method of Claim 219 wherein the salt is selected from the group  
20 consisting of sodium chloride, magnesium chloride, potassium chloride, ammonium chloride, sodium acetate, ammonium acetate, a combination of two or more of these salts, one of these salts in a phosphate buffer, and a combination of two or more these salts in a phosphate buffer.

25           226. The method of Claim 225 wherein the salt is sodium chloride in a phosphate buffer.

          227. The method of Claim 219 wherein nanoparticle-oligonucleotide

conjugates are produced which have the oligonucleotides are present on surface of the nanoparticles at a surface density of at least 10 picomoles/cm<sup>2</sup>.

228. The method of Claim 227 wherein the oligonucleotides are present on  
5 surface of the nanoparticles at a surface density of at least 15 picomoles/cm<sup>2</sup>.

229. The method of Claim 228 wherein the oligonucleotides are present on  
surface of the nanoparticles at a surface density of from about 15 picomoles/cm<sup>2</sup> to about  
40 picomoles/cm<sup>2</sup>.

10

230. The method of Claim 219 wherein each of the recognition  
oligonucleotides comprises a spacer portion and a recognition portion, the spacer portion  
having attached to it the moiety comprising a functional group which can bind to the  
nanoparticles.

15

231. The method of Claim 230 wherein the spacer portion comprises at least  
about 10 nucleotides.

232. The method of Claim 231 wherein the spacer portion comprises from  
20 about 10 to about 30 nucleotides.

233. The method of Claim 230 wherein the bases of the nucleotides of the  
spacers are all adenines, all thymines, all cytosines, all uracils, or all guanines.

25 234. The method of Claim 230 wherein the diluent oligonucleotides contain  
about the same number of nucleotides as are contained in the spacer portions of the  
recognition oligonucleotides.

235. The method of Claim 234 wherein the sequence of the diluent oligonucleotides is the same as the sequence of the spacer portions of the recognition oligonucleotides.

5           236. The method of Claim 219 wherein the oligonucleotides comprise at least two types of recognition oligonucleotides.

237. Nanoparticle-oligonucleotide conjugates which are nanoparticles having oligonucleotides attached to them, the oligonucleotides being present on surface of the  
10 nanoparticles at a surface density sufficient so that the conjugates are stable, at least some of the oligonucleotides having a sequence complementary to at least one portion of the sequence of a nucleic acid or another oligonucleotide..

238. The conjugates of Claim 237 wherein the oligonucleotides are present on  
15 surface of the nanoparticles at a surface density of at least 10 picomoles/cm<sup>2</sup>

239. The nanoparticles of Claim 238 wherein the oligonucleotides are present on surface of the nanoparticles at a surface density of at least 15 picomoles/cm<sup>2</sup>.

20           240. The nanoparticles of Claim 239 wherein the oligonucleotides are present on surface of the nanoparticles at a surface density of from about 15 picomoles/cm<sup>2</sup> to about 40 picomoles/cm<sup>2</sup>.

241. The nanoparticles of Claim 237 wherein the nanoparticles are metal  
25 nanoparticles or semiconductor nanoparticles.

242. The nanoparticles of Claim 241 wherein the nanoparticles are gold nanoparticles.

243. Nanoparticles having oligonucleotides attached to them, the oligonucleotides comprising at least one type of recognition oligonucleotides, each of the recognition oligonucleotides comprising a spacer portion and a recognition portion, the  
5 spacer portion being designed so that it is bound to the nanoparticles, the recognition portion having a sequence complementary to at least one portion of the sequence of a nucleic acid or another oligonucleotide.

244. The nanoparticles of Claim 243 wherein the spacer portion has a moiety  
10 covalently bound to it, the moiety comprising a functional group through which the spacer portion is bound to the nanoparticles.

245. The nanoparticles of Claim 243 wherein the spacer portion comprises at  
least about 10 nucleotides.

15

246. The nanoparticles of Claim 245 wherein the spacer portion comprises  
from about 10 to about 30 nucleotides.

247. The nanoparticles of Claim 243 wherein the bases of the nucleotides of the  
20 spacer portion are all adenines, all thymines, all cytosines, all uracils or all guanines.

248. The nanoparticles of Claim 243 wherein the oligonucleotides are present  
on surface of the nanoparticles at a surface density of at least 10 picomoles/cm<sup>2</sup>.

25 249. The nanoparticles of Claim 248 wherein the oligonucleotides are present  
on surface of the nanoparticles at a surface density of at least 15 picomoles/cm<sup>2</sup>.

250. The nanoparticles of Claim 249 wherein the oligonucleotides are present

on surface of the nanoparticles at a surface density of from about 15 picomoles/cm<sup>2</sup> to about 40 picomoles/cm<sup>2</sup>.

251. The nanoparticles of Claim 243 wherein the nanoparticles are metal  
5 nanoparticles or semiconductor nanoparticles.

252. The method of Claim 251 wherein the nanoparticles are gold nanoparticles.

10 253. Nanoparticles having oligonucleotides attached to them, the oligonucleotides comprising:

at least one type of recognition oligonucleotides, each of the types of recognition oligonucleotides comprising a sequence complementary to at least one portion of the sequence of a nucleic acid or another oligonucleotide; and

15 a type of diluent oligonucleotides.

254. The nanoparticles of Claim 253 wherein, each of the recognition oligonucleotides comprises a spacer portion and a recognition portion, the spacer portion being designed so that it is bound to the nanoparticles, the recognition portion having a  
20 sequence complementary to at least one portion of the sequence of a nucleic acid or another oligonucleotide.

255. The nanoparticles of Claim 254 wherein the spacer portion has a moiety covalently bound to it, the moiety comprising a functional group through which the  
25 spacer portion is bound to the nanoparticles.

256. The nanoparticles of Claim 254 wherein the spacer portion comprises at least about 10 nucleotides.

257. The nanoparticles of Claim 256 wherein the spacer portion comprises from about 10 to about 30 nucleotides.

5           258. The nanoparticles of Claim 254 wherein the bases of the nucleotides of the spacer portion are all adenines, all thymines, all cytosines, all uracils or all guanines.

259. The nanoparticles of Claim 253 wherein the oligonucleotides are present on surface of the nanoparticles at a surface density of at least 10 picomoles/cm<sup>2</sup>.

10           260. The nanoparticles of Claim 259 wherein the oligonucleotides are present on surface of the nanoparticles at a surface density of at least 15 picomoles/cm<sup>2</sup>.

261. The nanoparticles of Claim 260 wherein the oligonucleotides are present on surface of the nanoparticles at a surface density of from about 15 picomoles/cm<sup>2</sup> to about 40 picomoles/cm<sup>2</sup>.

262. The nanoparticles of Claim 254 wherein the diluent oligonucleotides contain about the same number of nucleotides as are contained in the spacer portions of the recognition oligonucleotides.

20

263. The nanoparticles of Claim 262 wherein the sequence of the diluent oligonucleotides is the same as that of the spacer portions of the recognition oligonucleotides.

25           264. The nanoparticles of Claim 253 wherein the nanoparticles are metal nanoparticles or semiconductor nanoparticles.

265. The nanoparticles of Claim 264 wherein the nanoparticles are gold

nanoparticles.

266. A method of detecting a nucleic acid comprising:

5 contacting the nucleic acid with at least one type of nanoparticle-oligonucleotide conjugates according to any one of Claims 237-242 under conditions effective to allow hybridization of the oligonucleotides on the nanoparticles with the nucleic acid; and

observing a detectable change brought about by hybridization of the oligonucleotides on the nanoparticles with the nucleic acid.

10 267. A method of detecting a nucleic acid comprising:

contacting the nucleic acid with at least one type of nanoparticles according to any one of Claims 243-265 under conditions effective to allow hybridization of at least one of the types of recognition oligonucleotides on the nanoparticles with the nucleic acid; and

15 observing a detectable change brought about by hybridization of the recognition oligonucleotides with the nucleic acid.

268. A method of detecting a nucleic acid having at least two portions comprising:

20 providing a type of nanoparticle-oligonucleotide conjugates according to any one of Claims 237-242, the oligonucleotides on each nanoparticle having a sequence complementary to the sequence of at least two portions of the nucleic acid;

contacting the nucleic acid and the conjugates under conditions effective to allow hybridization of the oligonucleotides on the nanoparticles with the two or more portions of the nucleic acid; and

25 observing a detectable change brought about by hybridization of the oligonucleotides on the nanoparticles with the nucleic acid.



269. A method of detecting a nucleic acid having at least two portions comprising:

contacting the nucleic acid with at least two types of nanoparticle-oligonucleotide conjugates according to any one of Claims 237-240, the oligonucleotides on the nanoparticles of the first type of conjugates having a sequence complementary to a first portion of the sequence of the nucleic acid, the oligonucleotides on the nanoparticles of the second type of conjugates having a sequence complementary to a second portion of the sequence of the nucleic acid, the contacting taking place under conditions effective to allow hybridization of the oligonucleotides on the nanoparticles with the nucleic acid; and

observing a detectable change brought about by hybridization of the oligonucleotides on the nanoparticles with the nucleic acid.

270. The method of Claim 269 wherein the contacting conditions include freezing and thawing.

271. The method of Claim 269 wherein the contacting conditions include heating.

272. The method of Claim 269 wherein the detectable change is observed on a solid surface.

273. The method of Claim 269 wherein the detectable change is a color change observable with the naked eye.

274. The method of Claim 273 wherein the color change is observed on a solid surface.

275. The method of Claim 269 wherein the nanoparticles are metal nanoparticles or semiconductor nanoparticles.

276. The method of Claim 269 wherein the nanoparticles are gold  
5 nanoparticles.

277. The method of Claim 269 wherein the oligonucleotides attached to the nanoparticles are labeled on their ends not attached to the nanoparticles with molecules that produce a detectable change upon hybridization of the oligonucleotides on the  
10 nanoparticles with the nucleic acid.

278. The method of Claim 277 wherein the nanoparticles are metallic or semiconductor nanoparticles and the oligonucleotides attached to the nanoparticles are labeled with fluorescent molecules.  
15

279. The method of Claim 269 wherein:  
the nucleic acid has a third portion located between the first and second portions, and the sequences of the oligonucleotides on the nanoparticles do not include sequences complementary to this third portion of the nucleic acid; and  
20 the nucleic acid is further contacted with a filler oligonucleotide having a sequence complementary to this third portion of the nucleic acid, the contacting taking place under conditions effective to allow hybridization of the filler oligonucleotide with the nucleic acid.

25 280. The method of Claim 269 wherein the nucleic acid is viral RNA or DNA.

281. The method of Claim 269 wherein the nucleic acid is a gene associated with a disease.

282. The method of Claim 269 wherein the nucleic acid is a bacterial DNA.

283. The method of Claim 269 wherein the nucleic acid is a fungal DNA.

5

284. The method of Claim 269 wherein the nucleic acid is a synthetic DNA, a synthetic RNA, a structurally-modified natural or synthetic RNA, or a structurally-modified natural or synthetic DNA.

10 285. The method of Claim 269 wherein the nucleic acid is from a biological source.

286. The method of Claim 269 wherein the nucleic acid is a product of a polymerase chain reaction amplification.

15

287. The method of Claim 269 wherein the nucleic acid is contacted with the first and second types of conjugates simultaneously.

20 288. The method of Claim 269 wherein the nucleic acid is contacted and hybridized with the oligonucleotides on the nanoparticles of first type of conjugates before being contacted with the second type of conjugates.

289. The method of Claim 288 wherein the first type of conjugates is attached to a substrate.

25

290. The method of Claim 269 wherein the nucleic acid is double-stranded and hybridization with the oligonucleotides on the nanoparticles results in the production of a triple-stranded complex.

291. A method of detecting a nucleic acid having at least two portions comprising:

5 providing a type of nanoparticles according to any one of Claims 243-252 having recognition oligonucleotides attached thereto, the recognition oligonucleotides on each nanoparticle comprising a sequence complementary to the sequence of at least two portions of the nucleic acid;

10 contacting the nucleic acid and the nanoparticles under conditions effective to allow hybridization of the oligonucleotides on the nanoparticles with the two or more portions of the nucleic acid; and

observing a detectable change brought about by hybridization of the oligonucleotides on the nanoparticles with the nucleic acid.

292. A method of detecting nucleic acid having at least two portions comprising:

15 contacting the nucleic acid with at least two types of nanoparticles according to any one of Claims 243-250 having recognition oligonucleotides attached thereto, the recognition oligonucleotides on the first type of nanoparticles comprising a sequence complementary to a first portion of the sequence of the nucleic acid, the  
20 recognition oligonucleotides on the second type of nanoparticles comprising a sequence complementary to a second portion of the sequence of the nucleic acid, the contacting taking place under conditions effective to allow hybridization of the recognition oligonucleotides on the nanoparticles with the nucleic acid; and

25 observing a detectable change brought about by hybridization of the recognition oligonucleotides on the nanoparticles with the nucleic acid.

293. The method of Claim 292 wherein the contacting conditions include freezing and thawing.

294. The method of Claim 292 wherein the contacting conditions include heating.

5 295. The method of Claim 292 wherein the detectable change is observed on a solid surface.

296. The method of Claim 292 wherein the detectable change is a color change observable with the naked eye.

10

297. The method of Claim 296 wherein the color change is observed on a solid surface.

15 298. The method of Claim 292 wherein the nanoparticles are metal nanoparticles or semiconductor nanoparticles.

299. The method of Claim 298 wherein the nanoparticles are made of gold.

20 300. The method of Claim 292 wherein the recognition oligonucleotides attached to the nanoparticles are labeled on their ends not attached to the nanoparticles with molecules that produce a detectable change upon hybridization of the oligonucleotides on the nanoparticles with the nucleic acid.

25 301. The method of Claim 300 wherein the nanoparticles are metallic or semiconductor nanoparticles and the oligonucleotides attached to the nanoparticles are labeled with fluorescent molecules.

302. The method of Claim 292 wherein:

the nucleic acid has a third portion located between the first and second portions, and the sequences of the oligonucleotides on the nanoparticles do not include sequences complementary to this third portion of the nucleic acid; and

5 the nucleic acid is further contacted with a filler oligonucleotide having a sequence complementary to this third portion of the nucleic acid, the contacting taking place under conditions effective to allow hybridization of the filler oligonucleotide with the nucleic acid.

10 303. The method of Claim 292 wherein the nucleic acid is viral RNA or DNA.

304. The method of Claim 292 wherein the nucleic acid is a gene associated with a disease.

15 305. The method of Claim 292 wherein the nucleic acid is a bacterial DNA.

306. The method of Claim 292 wherein the nucleic acid is a fungal DNA.

20 307. The method of Claim 292 wherein the nucleic acid is a synthetic DNA, a synthetic RNA, a structurally-modified natural or synthetic RNA, or a structurally-modified natural or synthetic DNA.

308. The method of Claim 292 wherein the nucleic acid is from a biological source.

25 309. The method of Claim 292 wherein the nucleic acid is a product of a polymerase chain reaction amplification.

310. The method of Claim 292 wherein the nucleic acid is contacted with the

first and second types of nanoparticles simultaneously.

311. The method of Claim 292 wherein the nucleic acid is contacted and hybridized with the oligonucleotides on the first type of nanoparticles before being  
5 contacted with the second type of nanoparticles.

312. The method of Claim 311 wherein the first type of nanoparticles is attached to a substrate.

10 313. The method of Claim 292 wherein the nucleic acid is double-stranded and hybridization with the oligonucleotides on the nanoparticles results in the production of a triple-stranded complex.

314. A method of detecting a nucleic acid having at least two portions  
15 comprising:

providing a type of nanoparticles according to any one of Claims 253-265 having recognition oligonucleotides attached thereto, the recognition oligonucleotides on each nanoparticle comprising a sequence complementary to the sequence of at least two portions of the nucleic acid;

20 contacting the nucleic acid and the nanoparticles under conditions effective to allow hybridization of the recognition oligonucleotides on the nanoparticles with the two or more portions of the nucleic acid; and

observing a detectable change brought about by hybridization of the recognition oligonucleotides on the nanoparticles with the nucleic acid.

25

315. A method of detecting nucleic acid having at least two portions comprising:

contacting the nucleic acid with at least two types of nanoparticles

according to any one of Claims 253-263 having recognition oligonucleotides attached thereto, the recognition oligonucleotides on the first type of nanoparticles comprising a sequence complementary to a first portion of the sequence of the nucleic acid, the recognition oligonucleotides on the second type of nanoparticles comprising a sequence  
5 complementary to a second portion of the sequence of the nucleic acid, the contacting taking place under conditions effective to allow hybridization of the recognition oligonucleotides on the nanoparticles with the nucleic acid; and

observing a detectable change brought about by hybridization of the recognition oligonucleotides on the nanoparticles with the nucleic acid.

10

316. The method of Claim 315 wherein the contacting conditions include freezing and thawing.

317. The method of Claim 315 wherein the contacting conditions include  
15 heating.

318. The method of Claim 315 wherein the detectable change is observed on a solid surface.

20 319. The method of Claim 315 wherein the detectable change is a color change observable with the naked eye.

320. The method of Claim 319 wherein the color change is observed on a solid surface.

25

321. The method of Claim 315 wherein the nanoparticles are metal nanoparticles or semiconductor nanoparticles.



322. The method of Claim 321 wherein the nanoparticles are made of gold.

323. The method of Claim 315 wherein the recognition oligonucleotides attached to the nanoparticles are labeled on their ends not attached to the nanoparticles  
5 with molecules that produce a detectable change upon hybridization of the recognition oligonucleotides on the nanoparticles with the nucleic acid.

324. The method of Claim 323 wherein the nanoparticles are metallic or semiconductor nanoparticles and the recognition oligonucleotides attached to the  
10 nanoparticles are labeled with fluorescent molecules.

325. The method of Claim 315 wherein:  
the nucleic acid has a third portion located between the first and second portions, and the sequences of the oligonucleotides on the nanoparticles do not include  
15 sequences complementary to this third portion of the nucleic acid; and  
the nucleic acid is further contacted with a filler oligonucleotide having a sequence complementary to this third portion of the nucleic acid, the contacting taking place under conditions effective to allow hybridization of the filler oligonucleotide with  
the nucleic acid.

20

326. The method of Claim 315 wherein the nucleic acid is viral RNA or DNA.

327. The method of Claim 315 wherein the nucleic acid is a gene associated with a disease.

25

328. The method of Claim 315 wherein the nucleic acid is a bacterial DNA.

329. The method of Claim 315 wherein the nucleic acid is a fungal DNA.

330. The method of Claim 315 wherein the nucleic acid is a synthetic DNA, a synthetic RNA, a structurally-modified natural or synthetic RNA, or a structurally-modified natural or synthetic DNA.

5

331. The method of Claim 315 wherein the nucleic acid is from a biological source.

332. The method of Claim 315 wherein the nucleic acid is a product of a polymerase chain reaction amplification.

10

333. The method of Claim 315 wherein the nucleic acid is contacted with the first and second types of nanoparticles simultaneously.

15

334. The method of Claim 315 wherein the nucleic acid is contacted and hybridized with the recognition oligonucleotides on the first type of nanoparticles before being contacted with the second type of nanoparticles.

20

335. The method of Claim 334 wherein the first type of nanoparticles is attached to a substrate.

336. The method of Claim 315 wherein the nucleic acid is double-stranded and hybridization with the oligonucleotides on the nanoparticles results in the production of a triple-stranded complex.

25

337. A method of detecting a nucleic acid having at least two portions comprising:

(a) contacting the nucleic acid with a substrate having oligonucleotides

attached thereto, the oligonucleotides having a sequence complementary to a first portion of the sequence of said nucleic acid, the contacting taking place under conditions effective to allow hybridization of the oligonucleotides on the substrate with said nucleic acid;

5 (b) contacting said nucleic acid bound to the substrate with a first type of nanoparticle-oligonucleotide conjugates according to any one of Claims 237-240, at least one of the types of oligonucleotides attached to the nanoparticles of the conjugates having a sequence complementary to a second portion of the sequence of said nucleic acid, the contacting taking place under conditions effective to allow hybridization of the  
10 oligonucleotides attached to the nanoparticles of the conjugates with said nucleic acid; and

(c) observing a detectable change.

338. The method of Claim 337 further comprising:

15 (d) contacting the first type of nanoparticle-oligonucleotide conjugates bound to the substrate with a second type of nanoparticle-oligonucleotide conjugates according to any one of Claims 237-240, at least one of the types of oligonucleotides attached to the nanoparticles of the second type of conjugates having a sequence complementary to the sequence of one of the types of oligonucleotides attached to the  
20 nanoparticles of the first type of conjugates, the contacting taking place under conditions effective to allow hybridization of the oligonucleotides attached to the nanoparticles of the first and second types of conjugates; and

(e) observing the detectable change.

25 339. The method of Claim 338 wherein at least one of the types of oligonucleotides on the nanoparticles of the first type of conjugates has a sequence complementary to the sequence of at least one of the types of oligonucleotides on the nanoparticles of the second type of conjugates and the method further comprises:

(f) contacting the second type of conjugates bound to the substrate with the first type of conjugates, the contacting taking place under conditions effective to allow hybridization of the oligonucleotides on the nanoparticles of the first and second types of conjugates; and

5 (g) observing the detectable change.

340. The method of Claim 339 wherein step (d) or steps (d) and (f) are repeated one or more times and the detectable change is observed.

10 341. The method of Claim 337 further comprising:

(d) providing a type of binding oligonucleotides having a sequence comprising at least two portions, the first portion being complementary to at least one of the types of oligonucleotides attached to the nanoparticles of the first type of conjugates;

(e) contacting the binding oligonucleotides with the first type of  
15 conjugates bound to the substrate, the contacting taking place under conditions effective to allow hybridization of the binding oligonucleotides with the oligonucleotides on the nanoparticles of the first type of conjugates;

(f) providing a second type of nanoparticle-oligonucleotide conjugates according to any one of Claims 237-240, at least one of the types of oligonucleotides  
20 attached to the nanoparticles of the second type of conjugates having a sequence complementary to the second portion of the sequence of the binding oligonucleotides;

(g) contacting the binding oligonucleotides bound to the substrate with the second type of conjugates, the contacting taking place under conditions effective to allow hybridization of the oligonucleotides attached to the nanoparticles of the second type of  
25 conjugates with the binding oligonucleotides; and

(h) observing the detectable change.

342. The method of Claim 341 further comprising:

(i) contacting the second type of conjugates bound to the substrate with the binding oligonucleotides, the contacting taking place under conditions effective to allow hybridization of the binding oligonucleotides with the oligonucleotides on the nanoparticles of the second type of conjugates;

5 (j) contacting the binding oligonucleotides bound to the substrate with the first type of conjugates, the contacting taking place under conditions effective to allow hybridization of the oligonucleotides on the nanoparticles of the first type of conjugates with the binding oligonucleotides; and

(k) observing the detectable change.

10

343. The method of Claim 342 wherein steps (e) and (g) or steps (e), (g), (i) and (j) are repeated one or more times, and the detectable change is observed.

15 344. The method of Claim 337 wherein the substrate is a transparent substrate or an opaque white substrate.

345. The method of Claim 344 wherein the detectable change is the formation of dark areas on the substrate.

20 346. The method of Claim 337 wherein the nanoparticles of the conjugates are metal nanoparticles or semiconductor nanoparticles.

347. The method of Claim 346 wherein the nanoparticles of the conjugates are made of gold or silver.

25

348. The method of Claim 337 wherein the substrate has a plurality of types of oligonucleotides attached to it in an array to allow for the detection of multiple portions of a single nucleic acid, the detection of multiple different nucleic acids, or both.

349. The method of Claim 337 wherein the substrate is contacted with silver stain to produce the detectable change.

5 350. The method of Claim 348 wherein the substrate is contacted with silver stain to produce the detectable change.

351. The method of Claim 337 wherein the detectable change is observed with an optical scanner.

10

352. The method of Claim 351 wherein the device is a flatbed scanner.

353. The method of Claim 351 wherein the scanner is linked to a computer loaded with software capable of calculating greyscale measurements, and the greyscale measurements are calculated to provide a quantitative measure of the amount of nucleic acid detected.

15

354. The method of Claim 337 wherein the oligonucleotides attached to the substrate are located between two electrodes, the nanoparticles of the conjugates are made of a material which is a conductor of electricity, and the detectable change is a change in conductivity.

20

355. The method of Claim 354 wherein the electrodes are made of gold, and the nanoparticles are made of gold.

25

356. The method of Claim 354 wherein the substrate is contacted with silver stain to produce the change in conductivity.

357. The method of Claim 348 wherein each of the plurality of oligonucleotides attached to the substrate in the array is located between two electrodes, the nanoparticles are made of a material which is a conductor of electricity, and the detectable change is a change in conductivity.

5

358. The method of Claim 357 wherein the electrodes are made of gold, and the nanoparticles are made of gold.

359. The method of Claim 357 wherein the substrate is contacted with silver  
10 stain to produce the change in conductivity.

360. A method of detecting a nucleic acid having at least two portions comprising:

(a) contacting the nucleic acid with a substrate having oligonucleotides  
15 attached thereto, the oligonucleotides having a sequence complementary to a first portion of the sequence of said nucleic acid, the contacting taking place under conditions effective to allow hybridization of the oligonucleotides on the substrate with said nucleic acid;

(b) contacting said nucleic acid bound to the substrate with a first type of  
20 nanoparticles according to any one of Claims 243-250 having one or more types of recognition oligonucleotides attached thereto, at least one of the types of recognition oligonucleotides comprising a sequence complementary to a second portion of the sequence of said nucleic acid, the contacting taking place under conditions effective to allow hybridization of the oligonucleotides on the nanoparticles with said nucleic acid;  
25 and

(c) observing a detectable change.

361. The method of Claim 360 further comprising:

(d) contacting the first type of nanoparticles bound to the substrate with a second type of nanoparticles according to any one of Claims 243-250 having recognition oligonucleotides attached thereto, at least one of the types of recognition oligonucleotides on the second type of nanoparticles comprising a sequence complementary to the sequence of one of the types of oligonucleotides on the first type of nanoparticles, the contacting taking place under conditions effective to allow hybridization of the oligonucleotides on the first and second types of nanoparticles; and

(e) observing the detectable change.

10           362. The method of Claim 360 wherein at least one of the types of recognition oligonucleotides on the first type of nanoparticles has a sequence complementary to the sequence of at least one of the types of oligonucleotides on the second type of nanoparticles and the method further comprises:

15           (f) contacting the second type of nanoparticles bound to the substrate with the first type of nanoparticles, the contacting taking place under conditions effective to allow hybridization of the oligonucleotides on the first and second types of nanoparticles; and

(g) observing the detectable change.

20           363. The method of Claim 362 wherein step (d) or steps (d) and (f) are repeated one or more times and the detectable change is observed.

364. The method of Claim 360 further comprising:

25           (d) providing a type of binding oligonucleotides having a sequence comprising at least two portions, the first portion being complementary to at least one of the types of oligonucleotides on the first type of nanoparticles;

(e) contacting the binding oligonucleotides with the first type of nanoparticles bound to the substrate, the contacting taking place under conditions



effective to allow hybridization of the binding oligonucleotides with the oligonucleotides on the first type of nanoparticles;

(f) providing a second type of nanoparticles according to any one of Claims 243-250 having recognition oligonucleotides attached thereto, at least one of the  
5 types of recognition oligonucleotides on the second type of nanoparticles comprising a sequence complementary to the second portion of the sequence of the binding oligonucleotides;

(g) contacting the binding oligonucleotides bound to the substrate with the second type of nanoparticles, the contacting taking place under conditions effective to  
10 allow hybridization of the oligonucleotides on the second type of nanoparticles with the binding oligonucleotides; and

(h) observing the detectable change.

365. The method of Claim 364 further comprising:

(i) contacting the second type of nanoparticles bound to the substrate with  
15 the binding oligonucleotides, the contacting taking place under conditions effective to allow hybridization of the binding oligonucleotides with the oligonucleotides on the second type of nanoparticles;

(j) contacting the binding oligonucleotides bound to the substrate with the  
20 first type of nanoparticles, the contacting taking place under conditions effective to allow hybridization of the oligonucleotides on the first type of nanoparticles with the binding oligonucleotides; and

(k) observing the detectable change.

25 366. The method of Claim 365 wherein steps (e) and (g) or steps (e), (g), (i) and (j) are repeated one or more times, and the detectable change is observed.

367. The method of Claim 360 wherein the substrate is a transparent substrate

or an opaque white substrate.

368. The method of Claim 367 wherein the detectable change is the formation of dark areas on the substrate.

5

369. The method of Claim 360 wherein the nanoparticles are metal nanoparticles or semiconductor nanoparticles.

370. The method of Claim 369 wherein the nanoparticles are made of gold or  
10 silver.

371. The method of Claim 360 wherein the substrate has a plurality of types of oligonucleotides attached to it in an array to allow for the detection of multiple portions of a single nucleic acid, the detection of multiple different nucleic acids, or both.

15

372. The method of Claim 360 wherein the substrate is contacted with silver stain to produce the detectable change.

373. The method of Claim 371 wherein the substrate is contacted with silver  
20 stain to produce the detectable change.

375. The method of Claim 360 wherein the detectable change is observed with an optical scanner.

25 376. The method of Claim 375 wherein the device is a flatbed scanner.

377. The method of Claim 375 wherein the scanner is linked to a computer loaded with software capable of calculating greyscale measurements, and the greyscale

measurements are calculated. to provide a quantitative measure of the amount of nucleic acid detected.

5 378. The method of Claim 360 wherein the oligonucleotides attached to the substrate are located between two electrodes, the nanoparticles are made of a material which is a conductor of electricity, and the detectable change is a change in conductivity.

10 379. The method of Claim 378 wherein the electrodes are made of gold, and the nanoparticles are made of gold.

380. The method of Claim 378 wherein the substrate is contacted with silver stain to produce the change in conductivity.

15 381. The method of Claim 371 wherein each of the plurality of oligonucleotides attached to the substrate in the array is located between two electrodes, the nanoparticles are made of a material which is a conductor of electricity, and the detectable change is a change in conductivity.

20 382. The method of Claim 381 wherein the electrodes are made of gold, and the nanoparticles are made of gold.

383. The method of Claim 381 wherein the substrate is contacted with silver stain to produce the change in conductivity.

25 384. A method of detecting a nucleic acid having at least two portions comprising:

(a) contacting the nucleic acid with a substrate having oligonucleotides attached thereto, the oligonucleotides having a sequence complementary to a first portion

of the sequence of said nucleic acid, the contacting taking place under conditions effective to allow hybridization of the oligonucleotides on the substrate with said nucleic acid;

(b) contacting said nucleic acid bound to the substrate with a first type of nanoparticles according to any one of Claims 253-263 having one or more types of recognition oligonucleotides attached thereto, at least one of the types of recognition oligonucleotides comprising a sequence complementary to a second portion of the sequence of said nucleic acid, the contacting taking place under conditions effective to allow hybridization of the recognition oligonucleotides on the nanoparticles with said nucleic acid; and

(c) observing a detectable change.

385. The method of Claim 384 further comprising:

(d) contacting the first type of nanoparticles bound to the substrate with a second type of nanoparticles according to any one of Claims 253-263 having recognition oligonucleotides attached thereto, at least one of the types of recognition oligonucleotides on the second type of nanoparticles comprising a sequence complementary to the sequence of one of the types of oligonucleotides on the first type of nanoparticles, the contacting taking place under conditions effective to allow hybridization of the oligonucleotides on the first and second types of nanoparticles; and

(e) observing the detectable change.

386. The method of Claim 385 wherein at least one of the types of recognition oligonucleotides on the first type of nanoparticles comprises a sequence complementary to the sequence of at least one of the types of oligonucleotides on the second type of nanoparticles and the method further comprises:

(f) contacting the second type of nanoparticles bound to the substrate with the first type of nanoparticles, the contacting taking place under conditions effective to

allow hybridization of the oligonucleotides on the first and second types of nanoparticles;  
and

(g) observing the detectable change.

5           387. The method of Claim 386 wherein step (d) or steps (d) and (f) are repeated one or more times and the detectable change is observed.

388. The method of Claim 384 further comprising:

10           (d) providing a type of binding oligonucleotides having a sequence comprising at least two portions, the first portion being complementary to at least one of the types of oligonucleotides on the first type of nanoparticles;

15           (e) contacting the binding oligonucleotides with the first type of nanoparticles bound to the substrate, the contacting taking place under conditions effective to allow hybridization of the binding oligonucleotides with the oligonucleotides on the first type of nanoparticles;

20           (f) providing a second type of nanoparticles according to any one of Claims 253-263 having recognition oligonucleotides attached thereto, at least one of the types of recognition oligonucleotides on the second type of nanoparticles comprising a sequence complementary to the second portion of the sequence of the binding oligonucleotides;

            (g) contacting the binding oligonucleotides bound to the substrate with the second type of nanoparticles, the contacting taking place under conditions effective to allow hybridization of the oligonucleotides on the second type of nanoparticles with the binding oligonucleotides; and

25           (h) observing the detectable change.

389. The method of Claim 388 further comprising:

(i) contacting the second type of nanoparticles bound to the substrate with

the binding oligonucleotides, the contacting taking place under conditions effective to allow hybridization of the binding oligonucleotides with the oligonucleotides on the second type of nanoparticles;

5 (j) contacting the binding oligonucleotides bound to the substrate with the first type of nanoparticles, the contacting taking place under conditions effective to allow hybridization of the oligonucleotides on the first type of nanoparticles with the binding oligonucleotides; and

(k) observing the detectable change.

10 390. The method of Claim 389 wherein steps (e) and (g) or steps (e), (g), (i) and (j) are repeated one or more times, and the detectable change is observed.

391. The method of Claim 384 wherein the substrate is a transparent substrate or an opaque white substrate.

15

392. The method of Claim 391 wherein the detectable change is the formation of dark areas on the substrate.

20 393. The method of Claim 384 wherein the nanoparticles are metal nanoparticles or semiconductor nanoparticles.

394. The method of Claim 393 wherein the nanoparticles are made of gold or silver.

25 395. The method of Claim 384 wherein the substrate has a plurality of types of oligonucleotides attached to it in an array to allow for the detection of multiple portions of a single nucleic acid, the detection of multiple different nucleic acids, or both.

396. The method of Claim 384 wherein the substrate is contacted with silver stain to produce the detectable change.

397. The method of Claim 395 wherein the substrate is contacted with silver stain to produce the detectable change.

398. The method of Claim 384 wherein the detectable change is observed with an optical scanner

399. The method of Claim 398 wherein the device is a flatbed scanner.

400. The method of Claim 398 wherein the scanner is linked to a computer loaded with software capable of calculating greyscale measurements, and the greyscale measurements are calculated, to provide a quantitative measure of the amount of nucleic acid detected.

401. The method of Claim 384 wherein the oligonucleotides attached to the substrate are located between two electrodes, the nanoparticles are made of a material which is a conductor of electricity, and the detectable change is a change in conductivity.

402. The method of Claim 401 wherein the electrodes are made of gold, and the nanoparticles are made of gold.

403. The method of Claim 401 wherein the substrate is contacted with silver stain to produce the change in conductivity.

404. The method of Claim 397 wherein each of the plurality of oligonucleotides attached to the substrate in the array is located between two electrodes,

the nanoparticles are made of a material which is a conductor of electricity, and the detectable change is a change in conductivity.

405. The method of Claim 404 wherein the electrodes are made of gold, and the  
5 nanoparticles are made of gold.

406. The method of Claim 404 wherein the substrate is contacted with silver  
stain to produce the change in conductivity.

10 407. A method of detecting a nucleic acid having at least two portions  
comprising:

(a) contacting the nucleic acid with a substrate having oligonucleotides  
attached thereto, the oligonucleotides being located between a pair of electrodes, the  
oligonucleotides having a sequence complementary to a first portion of the sequence of  
15 said nucleic acid, the contacting taking place under conditions effective to allow  
hybridization of the oligonucleotides on the substrate with said nucleic acid;

(b) contacting said nucleic acid bound to the substrate with a first type of  
nanoparticles, the nanoparticles being made of a material which can conduct electricity,  
the nanoparticles having one or more types of oligonucleotides attached thereto, at least  
20 one of the types of oligonucleotides having a sequence complementary to a second  
portion of the sequence of said nucleic acid, the contacting taking place under conditions  
effective to allow hybridization of the oligonucleotides on the nanoparticles with said  
nucleic acid; and

(c) detecting a change in conductivity.

25

408. The method of Claim 407 wherein the substrate has a plurality of pairs of  
electrodes located on it in an array to allow for the detection of multiple portions of a  
single nucleic acid, the detection of multiple different nucleic acids, or both, each of the



pairs of electrodes having a type of oligonucleotides attached to the substrate between them.

409. The method of Claim 407 wherein the nanoparticles are made of metal.

5

410. The method of Claim 407 wherein the nanoparticles are made of gold or silver.

411. The method of Claim 407 wherein the substrate is contacted with silver stain to produce the change in conductivity.

10

412. The method of Claim 407 further comprising:

(d) contacting the first type of nanoparticles bound to the substrate with a second type of nanoparticles, the nanoparticles being made of a material which can conduct electricity, the nanoparticles having oligonucleotides attached thereto, at least one of the types of oligonucleotides on the second type of nanoparticles comprising a sequence complementary to the sequence of one of the types of oligonucleotides on the first type of nanoparticles, the contacting taking place under conditions effective to allow hybridization of the oligonucleotides on the first and second types of nanoparticles; and

15

20

(e) detecting the change in conductivity.

413. The method of Claim 412 wherein at least one of the types of oligonucleotides on the first type of nanoparticles has a sequence complementary to the sequence of at least one of the types of oligonucleotides on the second type of nanoparticles and the method further comprises:

25

(f) contacting the second type of nanoparticles bound to the substrate with the first type of nanoparticles, the contacting taking place under conditions effective to allow hybridization of the oligonucleotides on the first and second types of nanoparticles;

and

(g) detecting the change in conductivity.

414. The method of Claim 413 wherein step (d) or steps (d) and (f) are repeated  
5 one or more times and the change in conductivity is detected.

415. The method of Claim 407 further comprising:

(d) contacting the first type of nanoparticles bound to the substrate with  
an aggregate probe having oligonucleotides attached thereto, the nanoparticles of the  
10 aggregate probe being made of a material which can conduct electricity, at least one of  
the types of oligonucleotides on the aggregate probe comprising a sequence  
complementary to the sequence of one of the types of oligonucleotides on the first type of  
nanoparticles, the contacting taking place under conditions effective to allow  
hybridization of the oligonucleotides on the aggregate probe with the oligonucleotides on  
15 the first type of nanoparticles;

(e) and detecting the change in conductivity.

416. A method of detecting nucleic acid having at least two portions  
comprising:

20 (a) contacting a nucleic acid with a substrate having oligonucleotides  
attached thereto, the oligonucleotides being located between a pair of electrodes, the  
oligonucleotides having a sequence complementary to a first portion of the sequence of  
said nucleic acid, the contacting taking place under conditions effective to allow  
hybridization of the oligonucleotides on the substrate with said nucleic acid;

25 (b) contacting said nucleic acid bound to the substrate with an aggregate  
probe having oligonucleotides attached thereto, at least one of the types of  
oligonucleotides on the aggregate probe comprising a sequence complementary to the  
sequence of a second portion of said nucleic acid, the nanoparticles of the aggregate

probe being made of a material which can conduct electricity, the contacting taking place under conditions effective to allow hybridization of the oligonucleotides on the aggregate probe with the nucleic acid; and

(c) detecting a change in conductivity.

5

417. A method of detecting a nucleic acid wherein the method is performed on a substrate, the method comprising detecting the presence, quantity, or both, of the nucleic acid with an optical scanner.

10

418. The method of Claim 417 wherein the device is a flatbed scanner.

15

419. The method of Claim 417 wherein the scanner is linked to a computer loaded with software capable of calculating greyscale measurements, and the greyscale measurements are calculated, to provide a quantitative measure of the amount of nucleic acid detected.

20

420. The method of Claim 417 wherein the scanner is linked to a computer loaded with software capable of providing an image of the substrate, and a qualitative determination of the presence of the nucleic acid, the quantity of the nucleic acid, or both, is made.

25

421. A kit comprising a container holding nanoparticle-oligonucleotide conjugates according to any one of Claims 237-242.

422. A kit comprising a container holding nanoparticles according to any one of Claims 243-265.

423. A kit comprising a substrate having attached thereto at least one pair of

electrodes with oligonucleotides attached to the substrate between the electrodes.

424. The kit of Claim 423 wherein the substrate has a plurality of pairs of electrodes attached to it in an array, to allow for the detection of multiple portions of a single nucleic acid, the detection of multiple different nucleic acids, or both.

425. A method of nanofabrication comprising providing at least one type of linking oligonucleotide having a selected sequence, the sequence of each type of linking oligonucleotide having at least two portions;

providing one or more types of nanoparticle-oligonucleotide conjugates according to any one of Claims 237-242, the oligonucleotides attached to the nanoparticles of each of the types of conjugates having a sequence complementary to the sequence of a portion of a linking oligonucleotide; and

contacting the linking oligonucleotides and conjugates under conditions effective to allow hybridization of the oligonucleotides attached to the nanoparticles of the conjugates to the linking oligonucleotides so that a desired nanomaterial or nanostructure is formed wherein the nanoparticles of the conjugates are held together by oligonucleotide connectors.

20

426. A method of nanofabrication comprising

providing at least one type of linking oligonucleotide having a selected sequence, the sequence of each type of linking oligonucleotide having at least two portions;

providing one or more types of nanoparticles according to any one of Claims 243-265, the recognition oligonucleotides on each of the types of nanoparticles comprising a sequence complementary to the sequence of a portion of a linking oligonucleotide; and

25

contacting the linking oligonucleotides and nanoparticles under conditions effective to allow hybridization of the oligonucleotides on the nanoparticles to the linking oligonucleotides so that a desired nanomaterial or nanostructure is formed wherein the nanoparticles are held together by oligonucleotide connectors.

5

427. A method of nanofabrication comprising:

providing at least two types of nanoparticle-oligonucleotide conjugates according to any one of Claims 237-242;

10 the oligonucleotides attached to the nanoparticles of the first type of conjugates having a sequence complementary to that of the oligonucleotides attached to the nanoparticles of the second type of conjugates;

the oligonucleotides attached to the nanoparticles of the second type of conjugates having a sequence complementary to that of the oligonucleotides attached to the nanoparticles of the first type of conjugates; and

15

contacting the first and second types of conjugates under conditions effective to allow hybridization of the oligonucleotides on the nanoparticles of the conjugates to each other so that a desired nanomaterial or nanostructure is formed.

428. A method of nanofabrication comprising:

20 providing at least two types of nanoparticles according to any one of Claims 243-265,

the recognition oligonucleotides on the first type of nanoparticles comprising a sequence complementary to that of the oligonucleotides on the second of the nanoparticles;

25

the recognition oligonucleotides on the second type of nanoparticles comprising a sequence complementary to that of the oligonucleotides on the first type of nanoparticles; and

contacting the first and second types of nanoparticles under conditions

effective to allow hybridization of the oligonucleotides on the nanoparticles to each other so that a desired nanomaterial or nanostructure is formed.

429. Nanomaterials or nanostructures composed of nanoparticle-  
5 oligonucleotide conjugates according to any one of Claims 237-242, the nanoparticles being held together by oligonucleotide connectors.

430. Nanomaterials or nanostructures composed of nanoparticles according to  
10 any one of Claims 243-265, the nanoparticles being held together by oligonucleotide connectors.

431. A method of separating a selected nucleic acid having at least two portions  
from other nucleic acids, the method comprising:

15 providing two or more types of nanoparticle-oligonucleotide conjugates according to any one of Claims 237-242, the oligonucleotides attached to the nanoparticles of each of the types of conjugates having a sequence complementary to the sequence of one of the portions of the selected nucleic acid; and

20 contacting the nucleic acids and conjugates under conditions effective to allow hybridization of the oligonucleotides on the nanoparticles of the conjugates with the selected nucleic acid so that the conjugates hybridized to the selected nucleic acid aggregate and precipitate.

432. A method of separating a selected nucleic acid having at least two portions  
from other nucleic acids, the method comprising:

25 providing two or more types of nanoparticles according to any one of Claims 243-265, the oligonucleotides on each of the types of nanoparticles having a sequence complementary to the sequence of one of the portions of the selected nucleic acid; and

contacting the nucleic acids and nanoparticles under conditions effective to allow hybridization of the oligonucleotides on the nanoparticles with the selected nucleic acid so that the nanoparticles hybridized to the selected nucleic acid aggregate and precipitate.

5

433. Nanoparticle-oligonucleotide conjugates which are nanoparticles having oligonucleotides attached to them, the oligonucleotides having a covalently bound cyclic disulfide functional group that can bind to the nanoparticles.

10

434. Nanoparticle-oligonucleotide conjugates which are nanoparticles having oligonucleotides attached to them, the oligonucleotides having a covalently bound polythiol functional group that can bind to the nanoparticles.

15

435. Nanoparticle-oligonucleotide conjugates which are nanoparticles having oligonucleotides attached to them, the oligonucleotides having a covalently bound cyclic disulfide functional group that can bind to the nanoparticles, at least some of the oligonucleotides having a sequence complementary to at least one portion of the sequence of a nucleic acid or another oligonucleotide.

20

436. Nanoparticle-oligonucleotide conjugates which are nanoparticles having oligonucleotides attached to them, the oligonucleotides having a covalently bound polythiol functional group that can bind to the nanoparticles, at least some of the oligonucleotides having a sequence complementary to at least one portion of the sequence of a nucleic acid or another oligonucleotide.

25

437. The conjugates of claims 435 or 436 wherein the oligonucleotides are further present at a surface density sufficient so that the conjugates are stable.

438. The conjugates of claim 437 wherein the oligonucleotides are present on surface of the nanoparticles at a surface density of at least 10 picomoles/cm<sup>2</sup>

439. The conjugates of claim 438 wherein the oligonucleotides are present on surface of the nanoparticles at a surface density of at least 15 picomoles/cm<sup>2</sup>.

440. The conjugates of claim 439 wherein the oligonucleotides are present on surface of the nanoparticles at a surface density of from about 15 picomoles/cm<sup>2</sup> to about 40 picomoles/cm<sup>2</sup>.

10

441. The conjugates of claims 435 or 436 wherein the nanoparticles are metal nanoparticles or semiconductor nanoparticles.

442. The conjugates of claim 441 wherein the nanoparticles are gold nanoparticles.

15

443. The conjugates of claims 435 or 436 wherein the oligonucleotides comprise at least one type of recognition oligonucleotides, the recognition portion having a sequence complementary to at least one portion of the sequence of a nucleic acid or another oligonucleotide.

20

444. The conjugates of claim 443 wherein each of the recognition oligonucleotides comprising a spacer portion and a recognition portion, the spacer portion being designed so that it is bound to the nanoparticles,

25

445. The conjugates of claim 444 wherein the spacer portion has a moiety covalently bound to it, the moiety comprising a cyclic disulfide functional group through which the spacer portion is bound to the nanoparticles.



446. The conjugates of claim 444 wherein the spacer portion has a moiety covalently bound to it, the moiety comprising a polythiol functional group through which the spacer portion is bound to the nanoparticles.

5

447. The conjugates of claim 442 wherein the spacer portion comprises at least about 10 nucleotides.

448. The conjugates of claim 447 wherein the spacer portion comprises from about 10 to about 30 nucleotides.

449. The conjugates of claim 448 wherein the bases of the nucleotides of the spacer portion are all adenines, all thymines, all cytosines, all uracils or all guanines.

15 450. The conjugates of claims 435 or 436 further a type of diluent oligonucleotides.

451. The nanoparticles of claim 450 wherein the diluent oligonucleotides contain about the same number of nucleotides as are contained in the spacer portions of the recognition oligonucleotides.

20

452. The nanoparticles of claim 451 wherein the sequence of the diluent oligonucleotides is the same as that of the spacer portions of the recognition oligonucleotides.

25

453. A method of binding oligonucleotides to nanoparticles to produce nanoparticle-oligonucleotide conjugates, the method comprising:

providing oligonucleotides having covalently bound cyclic disulfide

function groups that can bind to nanoparticles; and

contacting the oligonucleotides and the nanoparticles under conditions effective to allow at least some of the oligonucleotides to bind to the nanoparticles to produce the nanoparticle-oligonucleotide conjugates.

5

454. A method of binding oligonucleotides to nanoparticles to produce nanoparticle-oligonucleotide conjugates, the method comprising:

providing oligonucleotides having covalently bound polythiol function groups that can bind to nanoparticles; and

10

contacting the oligonucleotides and the nanoparticles under conditions effective to allow at least some of the oligonucleotides to bind to the nanoparticles to produce the nanoparticle-oligonucleotide conjugates.

455. The method of claims 454 or 455 wherein the nanoparticles are metal nanoparticles or semiconductor nanoparticles.

456. The method of claim 455 wherein the nanoparticles are gold nanoparticles.

457. The method of claims 453 or 454 wherein, the oligonucleotides comprising at least one type of recognition oligonucleotides, each of the recognition oligonucleotides comprising a spacer portion and a recognition portion, the spacer portion having a moiety covalently bound thereto, the moiety comprising a functional group which can bind to the nanoparticles.

25

458. The method of claim 457 wherein the spacer portion comprises at least about 10 nucleotides.

459. The method of claims 458 wherein the spacer portion comprises from

about 10 to about 30 nucleotides.

460. The method of claims 459 wherein the bases of the nucleotides of the spacer are all adenines, all thymines, all cytosines, all uracils, or all guanines.

5

461. The method of claim 457, wherein the oligonucleotides further comprising a type of diluent oligonucleotides and contacting the oligonucleotides with the nanoparticles under conditions effective to allow at least some of each of the types of oligonucleotides to bind to the nanoparticles to produce the nanoparticle-oligonucleotide  
10 conjugates.

462. The method of claim 461 wherein the diluent oligonucleotides contain about the same number of nucleotides as are contained in the spacer portions of the recognition oligonucleotides.

15

463. The method of claim 462 wherein the sequence of the diluent oligonucleotides is the same as the sequence of the spacer portions of the recognition oligonucleotides.

20

464. The method of claim 457 wherein the oligonucleotides comprise at least two types of recognition oligonucleotides.

465. A method of binding oligonucleotides to charged nanoparticles to produce nanoparticle-oligonucleotide conjugates, the method comprising:

25

providing oligonucleotides having covalently bound cyclic disulfide function groups that can bind to nanoparticles, the oligonucleotides comprising:

a type of recognition oligonucleotides; and

a type of diluent oligonucleotides;

contacting the oligonucleotides with the nanoparticles in water for a period of time sufficient to allow at least some of each of the types of oligonucleotides to bind to the nanoparticles;

5 adding at least one salt to the water to form a salt solution, the ionic strength of the salt solution being sufficient to overcome at least partially the electrostatic attraction or repulsion of the oligonucleotides for the nanoparticles and the electrostatic repulsion of the oligonucleotides for each other; and

10 contacting the oligonucleotides and nanoparticles in the salt solution for an additional period of time sufficient to allow additional oligonucleotides of each of the types of oligonucleotides to bind to the nanoparticles to produce the nanoparticle-oligonucleotide conjugates.

466. A method of binding oligonucleotides to charged nanoparticles to produce nanoparticle-oligonucleotide conjugates, the method comprising:

15 providing oligonucleotides having covalently bound polythiol function groups that can bind to nanoparticles, the oligonucleotides comprising:

- a type of recognition oligonucleotides; and
- a type of diluent oligonucleotides;

20 contacting the oligonucleotides with the nanoparticles in water for a period of time sufficient to allow at least some of each of the types of oligonucleotides to bind to the nanoparticles;

25 adding at least one salt to the water to form a salt solution, the ionic strength of the salt solution being sufficient to overcome at least partially the electrostatic attraction or repulsion of the oligonucleotides for the nanoparticles and the electrostatic repulsion of the oligonucleotides for each other; and

contacting the oligonucleotides and nanoparticles in the salt solution for an additional period of time sufficient to allow additional oligonucleotides of each of the types of oligonucleotides to bind to the nanoparticles to produce the nanoparticle-

oligonucleotide conjugates.

467. The method of claims 465 or 466 wherein the nanoparticles are metal nanoparticles or semiconductor nanoparticles.

5

468. The method of claims 467 wherein the nanoparticles are gold nanoparticles.

469. The method of claims 465 or 466 wherein all of the salt is added to the  
10 water in a single addition.

470. The method of claims 465 or 466 wherein the salt is added gradually over time.

15 471. The method of claims 465 or 466 wherein the salt is selected from the group consisting of sodium chloride, magnesium chloride, potassium chloride, ammonium, chloride, sodium, acetate, ammonium acetate, a combination of two or more of these salts, one of these salts in a phosphate buffer, and a combination of two or more these salts in a phosphate buffer.

20

472. The method of claim 471 wherein the salt is sodium chloride in a phosphate buffer.

25 473. The method of claims 465 or 466 wherein nanoparticle-oligonucleotide conjugates are produced which have the oligonucleotides are present on surface of the nanoparticles at a surface density of at least 10 picomoles/cm<sup>2</sup>.

474. The method of claim 473 wherein the oligonucleotides are present on

surface of the nanoparticles at a surface density of at least 15 picomoles/cm<sup>2</sup>.

475. The method of claim 474 wherein the oligonucleotides are present on surface of the nanoparticles at a surface density of from about 15 picomoles/cm<sup>2</sup> to about  
5 40 picomoles/cm<sup>2</sup>.

476. The method of claim 465 wherein each of the recognition oligonucleotides comprises a spacer portion and a recognition portion, the spacer portion having attached to it the moiety comprising a cyclic disulfide functional group which can bind to the  
10 nanoparticles.

477. The method of claim 466 wherein each of the recognition oligonucleotides comprises a spacer portion and a recognition portion, the spacer portion having attached to it the moiety comprising a polythiol functional group which can bind to the  
15 nanoparticles.

478. The method of claims 476 or 477 wherein the spacer portion comprises at least about 10 nucleotides.

20 479. The method of claim 478 wherein the spacer portion comprises from about 10 to about 30 nucleotides.

480. The method of claims 476 or 477 wherein the bases of the nucleotides of the spacers are all adenines, all thymines, all cytosines, all uracils, or all guanines.  
25

481. The method of claims 476 or 477 wherein the diluent oligonucleotides contain about the same number of nucleotides as are contained in the spacer portions of the recognition oligonucleotides.

482. The method of claim 481 wherein the sequence of the diluent oligonucleotides is the same as the sequence of the spacer portions of the recognition oligonucleotides.

5

483. The method of claims 476 or 477 wherein the oligonucleotides comprise at least two types of recognition oligonucleotides.

484. Oligonucleotides having a covalently bound cyclic disulfide functional group that can bind to the nanoparticles.

10

485. Oligonucleotides having a covalently bound polythiol functional group that can bind to the nanoparticles.

15

486. The compositions according to claims 433, 435, 445, 446, 453, 465, and 484 wherein a large hydrophobic group is located between the oligonucleotide and the cyclic disulfide functional group.

20

487. A method for detecting an analyte in a sample comprising:  
providing a type of nanoparticle conjugate having oligonucleotides bound thereto, at least a portion of the oligonucleotides attached to the nanoparticles are bound, as a result of hybridization, to second oligonucleotides having a specific binding complement of said analyte bound thereto;

25

contacting the analyte with the nanoparticle conjugate under conditions effective to allow specific binding interactions between the analyte and specific binding complement bound to the nanoparticle conjugate; and

observing a detectable change brought about by the specific binding interaction of the analyte and the specific binding complement of said analyte.

488. A method for detecting an analyte comprising:

providing a type of nanoparticle conjugate having oligonucleotides bound thereto, at least a portion of the oligonucleotides attached to the nanoparticles are bound, as a

5 result of hybridization, to a first portion of a linker oligonucleotide, the linker oligonucleotide having a second portion that is bound, as a result of hybridization, to oligonucleotides having bound thereto a specific binding complement of said analyte;

10 contacting the analyte with a nanoparticle conjugate under conditions effective to allow specific binding interaction between the analyte and specific binding complement bound to the nanoparticle conjugate; and

observing a detectable change brought about by the specific binding interaction of the analyte and the specific binding complement of said analyte.

489. A method for detecting an analyte comprising:

15 providing (i) an analyte having an oligonucleotide bound thereto, (ii) a first type of nanoparticles having oligonucleotides bound thereto, the oligonucleotides bound to the first type of nanoparticles having a sequence that is complementary to the sequence of the oligonucleotide bound to the analyte, and (iii) a second type of nanoparticle conjugate having oligonucleotides bound thereto, a portion of the oligonucleotides bound to the  
20 second type of nanoparticle are bound, as a result of hybridization, to oligonucleotides having bound thereto a specific binding complement of said analyte;

25 contacting the oligonucleotide bound to the analyte with the first type of nanoparticles under conditions effective to allow hybridization between the oligonucleotides bound to the analyte with the oligonucleotides attached to the first type of nanoparticles to form a nanoparticle analyte conjugate;

contacting the nanoparticle analyte conjugate with a second type of nanoparticle conjugates under conditions effective to allow specific binding interaction between the analyte and specific binding complement of the second type of nanoparticle conjugate;



and

observing a detectable change brought about by the specific binding interaction of the analyte and the specific binding complement of said analyte.

- 5           490. A method for detecting an analyte comprising:
- providing (ii) a linker oligonucleotide, the linker oligonucleotide having at least two portions, (iii) a first type of nanoparticle have oligonucleotides attached thereto, a least a portion of the oligonucleotides bound to the first type of nanoparticles have a sequence that is complementary to a second portion of the linker oligonucleotide; (i) an
- 10          analyte having an oligonucleotide bound thereto, the oligonucleotide having a sequence complementary to the first portion of the linker oligonucleotide; and (iv) a second type of nanoparticles having oligonucleotides bound thereto, at least a portion of the oligonucleotides bound to the second type of nanoparticles are bound, as a result of hybridization, to an oligonucleotide having bound thereto a specific binding complement
- 15          of the analyte;
- contacting the linker oligonucleotide with the first type of nanoparticles under conditions effective to allow hybridization between the oligonucleotide attached to the first type of nanoparticles with a first portion of the linker oligonucleotide;
- contacting the linker oligonucleotide with the oligonucleotide having the analyte
- 20          bound thereto under conditions effective to allow hybridization between the oligonucleotide having analyte bound thereto with a second portion of the linker oligonucleotide;
- contacting the analyte bound to the first type of nanoparticles with a second type of nanoparticles under conditions effective to allow specific binding interactions between
- 25          the analyte bound to the first type of nanoparticles and the specific binding complement bound to the second type of nanoparticles; and
- observing the detectable change brought about by the specific binding of the analyte to the specific binding complement of the analyte.

491. The method according to any one of claim 487-490, wherein the analyte is polyvalent and binds to two or more nanoparticle conjugates.

5 492. The method according to any one of claim 487-490, wherein the analyte is polyvalent and specifically binds to two or more nanoparticle conjugates.

493. The method according to any one of claim 487-490, wherein the contacting conditions include freezing and thawing.  
10

494. The method according to any one of claim 487-490, wherein the contacting conditions include heating.

495. The method according to any one of claim 487-490, wherein the detectable change is observed on a solid surface.  
15

496. The method according to any one of claim 487-490, wherein the detectable change is a color change observable with the naked eye.

20 497. The method according to any one of claim 487-490, wherein the color change is observed on a solid surface.

498. The method according to any one of claim 487-490, wherein the nanoparticles are made of gold.  
25

499. A method for detecting an analyte comprising:  
providing (i) a support having an analyte bound thereto and (ii) a nanoparticle conjugate having oligonucleotides bound thereto, a least a portion of the oligonucleotides

are bound, as a result of hybridization, to second oligonucleotides having a specific binding complement of said analyte;

contacting the analyte bound to the support to the nanoparticle conjugate under conditions effective to allow specific binding interactions between the analyte and specific binding complement bound to the nanoparticle conjugate; and

observing a detectable change dependent on the specific binding of the analyte to the specific binding complement of the analyte.

500. A method for detecting an analyte comprising:

providing (i) a support having a oligonucleotides bound thereto, (ii) an analyte having an oligonucleotide bound thereto, the oligonucleotide bound to the analyte has a sequence that is complementary to the oligonucleotides bound to the support; and (iii) a type of nanoparticle conjugate having oligonucleotides bound thereto, at least a portion of the oligonucleotides bound to the nanoparticle are bound, as a result of hybridization, to second oligonucleotides having bound thereto a specific binding complement of said analyte;

contacting the oligonucleotides bound to the support with the oligonucleotide bound to the analyte under conditions effective to allow hybridization between the oligonucleotides bound to the support and the oligonucleotides bound to the analytes;

contacting the analyte bound to the support with the nanoparticle conjugate under conditions effective to allow for specific binding interactions between the analyte bound to the support and the specific binding complement bound to the nanoparticle; and

observing a detectable change dependent on the specific binding of the analyte to the specific binding complement of the analyte.

501. A method for detecting an analyte in a sample comprising:

providing (i) a support having oligonucleotides bound thereto, (ii) a linker oligonucleotide, (ii) an analyte having an oligonucleotide bound thereto,(iii) a type of

nanoparticle conjugate having oligonucleotides bound thereto, wherein at least a portion of the oligonucleotides bound to the nanoparticle conjugate are bound, as a result of hybridization, to oligonucleotides having bound thereto a specific binding complement of said analyte, the sequence of the linker oligonucleotide having at least two portions, the oligonucleotides bound to the support have a sequence that is complementary to the first portion of the linker oligonucleotide, the oligonucleotide bound to the analyte has a sequence that is complementary to the second portion of the linker oligonucleotides;

5           contacting the linker oligonucleotide with the oligonucleotide bound to the support under conditions effective to allow hybridization between the oligonucleotides bound to the support with the first portion of the linker oligonucleotide;

10           contacting the linker oligonucleotide with the oligonucleotide bound to the analyte under conditions effective to allow hybridization between the oligonucleotide bound to the analyte and the second portion of the linker oligonucleotide;

          contacting analyte bound to the support with the nanoparticle conjugate under conditions effective to allow specific binding interaction between the analyte bound to the support and the specific binding complement bound to the nanoparticle conjugate;

15           and

          observing a detectable change dependent on the specific binding of the analyte to the specific binding complement of the analyte.

20

502. A method for detecting an analyte comprising:

          providing (i) a support having oligonucleotides bound thereto, (ii) an analyte having oligonucleotides bound thereto, the sequence of the oligonucleotide bound to the analyte is complementary to the sequence of the oligonucleotides bound the support; (iii)

25           a type of nanoparticles having oligonucleotides bound thereto, at least a portion of the oligonucleotides attached to the nanoparticle are bound, as a result of hybridization, to a first portion of a linker oligonucleotide, a second portion of the linker oligonucleotide is further bound, as a result of hybridization, to an oligonucleotide having a oligonucleotide

having bound thereto a specific binding complement of said analyte;

contacting the oligonucleotides bound to the support with oligonucleotide bound to an analyte under conditions effective to allow hybridization between the oligonucleotides bound to the support with the oligonucleotides bound to the analyte;

5 contacting the analyte bound to the support with the the nanoparticle conjugate under conditions effective to allow specific binding interactions between the analyte bound to the support and the specific binding complement bound to the nanoparticle; and observing a detectable change dependent on the specific binding of the analyte to the specific binding complement of the analyte.

10

503. A method for detecting an analyte comprising:

providing (i) a support having an analyte bound thereto, (ii) an aggregate probe comprising at least two types of nanoparticles having oligonucleotides bound thereto, the nanoparticles of the aggregate probe are bound to each other as a result of the hybridization of some of the oligonucleotides attached to them, and at least one of the types of nanoparticles of the aggregate probe have oligonucleotides attached thereto which are bound, as a result of hybridization, to second oligonucleotides having bound thereto a specific binding complement of said analyte;

15 contacting the support with the aggregate probe under conditions effective to allow specific binding interactions between the analyte bound to the support and specific binding complement bound to the aggregate probe; and

20 observing a detectable change dependent on the specific binding of the analyte to the specific binding complement of the analyte.

25

504. A method for detecting an analyte comprising:

providing (i) a support having an oligonucleotide bound thereto; (ii) an analyte having an oligonucleotide bound thereto, the oligonucleotide bound to the analyte has a sequence that is complementary to the sequence of the oligonucleotides bound to the

support, (iii) an aggregate probe comprising at least two types of nanoparticles having oligonucleotides bound thereto, the nanoparticles of the aggregate probe are bound to each other as a result of the hybridization of some of the oligonucleotides attached to them, and at least one of the types of nanoparticles of the aggregate probe have

5 oligonucleotides attached thereto which are bound, as a result of hybridization, to second oligonucleotides having bound thereto a specific binding complement of said analyte;

contacting a support having oligonucleotides bound thereto with the analyte having an oligonucleotide bound thereto. The contacting occurs under conditions effective to allow hybridization of the oligonucleotides bound to the analyte with the

10 oligonucleotides bound to the support; and

contacting the analyte bound to the support with an aggregate probe under conditions effective to allow specific binding interactions between the analyte bound to the support and specific binding complement bound to the aggregate probe; and

observing a detectable change dependent on the specific binding of the analyte to

15 the specific binding complement of the analyte.

505. A method for detecting an analyte comprising:

providing (i) a support having a oligonucleotides bound thereto, (ii) a linker oligonucleotide having at least two portions,(iii) an analyte having oligonucleotides

20 bound thereto, (iv) an aggregate probe comprising at least two types of nanoparticles having oligonucleotides bound thereto, the nanoparticles of the aggregate probe are bound to each other as a result of the hybridization of some of the oligonucleotides attached to them, at least one of the types of nanoparticles of the aggregate probe have some oligonucleotides attached thereto which bound, as a result of hybridization, to

25 second oligonucleotides having bound thereto a specific binding complement of said analyte, the oligonucleotides bound to the support has a sequence that is complementary to a first portion of the linker oligonucleotide, the oligonucleotide bound to the analyte has a sequence that is complementary with the second portion of the linker

oligonucleotide;

contacting the linker oligonucleotide with the oligonucleotides bound to the support under conditions effective to allow hybridization between the oligonucleotides bound to the support and the first portion of the linker oligonucleotide;

5 contacting the linker oligonucleotide with the oligonucleotide bound to the analyte under conditions effective to allow hybridization between the second portion of the linker oligonucleotide bound to the support and the oligonucleotide bound to the analyte;

10 contacting the analyte bound to the support with the aggregate probe under conditions effective to allow specific binding interactions between the analyte bound to the support and specific binding complement bound to the aggregate probe; and

observing a detectable change dependent on the specific binding of the analyte to the specific binding complement of the analyte.

15 506. A method for detecting an analyte comprising:

providing (i) a support having oligonucleotides bound thereto, (ii) an analyte having oligonucleotide bound thereto, the oligonucleotide has a sequence that is complementary to the sequence of the oligonucleotides bound to the support, (iii) an aggregate probe comprising at least two types of nanoparticles having oligonucleotides bound thereto, the nanoparticles of the aggregate probe are bound to each other as a result of the hybridization of some of the oligonucleotides attached to them and at least one of the types of nanoparticles of the aggregate probe have some oligonucleotides attached thereto which bound to a first portion of a linker oligonucleotide as a result of hybridization, a second portion of the second linker oligonucleotide is bound, as a result of hybridization, to a oligonucleotide having bound thereto a specific binding complement of said analyte;

20  
25

contacting a support having oligonucleotides bound thereto with an oligonucleotide having analyte bound thereto under conditions effective to allow

hybridization of the oligonucleotides bound to the analyte with the oligonucleotides bound to the support;

contacting the analyte bound to the support with the aggregate probe under conditions effective to allow specific binding interactions between the analyte bound to the support and the specific binding complement bound to the aggregate probe; and

observing a detectable change dependent on the specific binding of the analyte to the specific binding complement of the analyte.

507. A method for detecting an analyte comprising:

providing (i) a support having an analyte bound thereto and (ii) a nanoparticle conjugate having oligonucleotides bound thereto, at least some of the oligonucleotides attached to the nanoparticle are bound, as a result of hybridization, to second oligonucleotides having bound thereto a specific binding complement of said analyte;

contacting a support having an analyte bound thereto with the nanoparticle conjugate under conditions effective to allow specific binding interactions between the analyte bound to the support and specific binding complement bound to the nanoparticle conjugate;

contacting the nanoparticle conjugate bound to the support with silver stain to produce a detectable change; and

observing the detectable change dependent on the specific binding of the analyte and the specific binding complement of the analyte.

508. A method for detecting a polyvalent analyte comprising:

providing a nanoparticle probe having oligonucleotides bound thereto, at least some of the oligonucleotides attached to the nanoparticle are bound to a first portion of a reporter oligonucleotide as a result of hybridization, a second portion of the reporter oligonucleotide is bound, as a result of hybridization, to an oligonucleotide having bound thereto a specific binding complement of the analyte;



contacting a polyvalent analyte with the nanoparticle probe under conditions effective to allow specific binding interactions between the analyte and the nanoparticle probe and to form an aggregated complex;

isolating the aggregated complex;

5       subjecting the aggregated complex to conditions effective to dehybridize the aggregated complex and to release the reporter oligonucleotide; and

detecting for the presence of reporter oligonucleotide.

509.   A method for detecting a nucleic acid comprising:

10       providing (i) one or more types of nanoparticles having oligonucleotides bound thereto, the oligonucleotides bound to the nanoparticles have a sequence that is complementary to a first portion of the nucleic acid and (ii) a complex comprising streptavidin or avidin bound, by specific binding interaction, to two or more biotin molecules each having oligonucleotides bound thereto, the oligonucleotides bound to  
15       biotin have a sequence that is complementary to a second portion of the nucleic acid;

contacting the nucleic acid, nanoparticle conjugate and complex under conditions effective to allow hybridization of the first portion of the nucleic acid with the oligonucleotides bound to the nanoparticles and the second portion of the nucleic acid with the oligonucleotides bound to the complex; and

20       observing the detectable change resulting from the hybridization of the nanoparticles, the complex and the nucleic acid.

510.   A method for detecting a nucleic acid comprising:

25       providing (i) one or more types of nanoparticles having oligonucleotides bound thereto, the oligonucleotides bound to the nanoparticles have a sequence that is complementary to a first portion of the nucleic acid, (ii) oligonucleotides having biotin bound thereto; the oligonucleotide bound to the biotins have a sequence that is complementary to a second portion of the nucleic acid, and (iii) streptavidin or avidin;

- contacting the nucleic acid with the nanoparticle conjugate and oligonucleotide bound to biotin under conditions effective to allow hybridization between the first portion of the nucleic acid with the oligonucleotides attached to the nanoparticles and the second portion of the nucleic acid with the oligonucleotides attached to the biotin to form a
- 5 complex;
- contacting the complex with streptavidin or avidin under conditions effective to allow specific binding interaction between the biotin bound to the complex with streptavidin or avidin; and
- observing the detectable change resulting from the specific binding of biotin
- 10 bound to the complex with streptavidin or avidin.

511. A method for detecting a nucleic acid comprising:
- providing a first type of nanoparticle conjugate having oligonucleotides attached thereto, at least some of the oligonucleotides attached to the nanoparticles have a
- 15 sequence that is complementary to a first portion of the nucleic acid;
- contacting the nucleic acid with a first type of nanoparticle under conditions effective to allow hybridization between the oligonucleotides attached to the nanoparticle and the first portion of the nucleic acid;
- providing an oligonucleotide having a sbp member bound thereto is provided, the
- 20 oligonucleotide bound to the sbp member has a sequence that is complementary to the second portion of the sequence of the nucleic acid;
- contacting the nucleic acid bound to the first type of nanoparticle under conditions effective to allow hybridization between the oligonucleotide bound to the sbp member and the second portion of the nucleic acid;
- 25 providing a second type of nanoparticle conjugate having oligonucleotides bound thereto is provided, at least a portion of the oligonucleotides bound to the second type of nanoparticle are bound, as a result of hybridization, to oligonucleotides having bound thereto a specific binding complement of said analyte;

contacting the nucleic acid bound to the first type of nanoparticle and the oligonucleotide bound to the sbp member with the oligonucleotides bound to the second type of nanoparticles under conditions effective to allow specific binding interaction between the sbp member bound to the first type of nanoparticle and the sbp complement  
5 bound to the second type of nanoparticle; and  
observing the detectable change resulting from the specific binding of biotin with streptavidin or avidin.

10 512. The method according to claim 511, wherein the sbp member is biotin.

513. The method according to claim 511, wherein the sb complement is streptavidin or avidin.

15 514. A method for detecting a nucleic acid comprising:  
providing a support having oligonucleotides bound thereto, the oligonucleotides bound to the support have a sequence that is complementary to the first portion of the nucleic acid;

20 contacting the nucleic acid with a support having oligonucleotides bound thereto under conditions effective to allow hybridization between the oligonucleotides bound to the support with the first portion of the nucleic acid;

providing an oligonucleotide having a sbp member bound thereto, the oligonucleotide bound to the sbp member has a sequence that is complementary to the second portion of the nucleic acid;

25 contacting the nucleic acid bound to the support with the oligonucleotide bound to the sbp member under conditions effective to allow hybridization between the oligonucleotide bound to the sbp member and the second portion of the nucleic acid;

providing a type of nanoparticle conjugate having oligonucleotides bound thereto, at least a portion of the oligonucleotides bound to the nanoparticle conjugate are bound,

as a result of hybridization, to oligonucleotides having bound thereto a specific binding complement of said sbp member;

contacting the sbp member bound to the support with the nanoparticle conjugate under conditions effective to allow specific binding interaction between the sbp member bound to the support and the specific binding complement bound to the nanoparticle; and  
5 observing a detectable change dependent on the specific binding of the sbp member and the specific binding complement.

515. The method according to claim 514, wherein the sbp member is  
10 streptavidin or avidin.

516. The method according to claim 514, wherein the sb complement is biotin.

517. A method for detecting a nucleic acid comprising:  
15 providing a nanoparticle conjugate having oligonucleotides attached thereto, at least some of the oligonucleotides attached to the nanoparticles have a sequence that is complementary to the first portion of the nucleic acid;  
contacting a nucleic acid with the oligonucleotides bound to the nanoparticle conjugate under conditions effective to allow hybridization of the oligonucleotides bound  
20 to the nanoparticles with the first portion of the nucleic acid;  
providing an oligonucleotide having sbp member bound thereto, the oligonucleotide bound to the sbp member has a sequence that is complementary to the second portion of the nucleic acid;  
contacting the nucleic acid with the oligonucleotide having the sbp member under  
25 conditions effective to allow hybridization between the oligonucleotide having the sbp member and the nucleic acid;  
providing a support having bound thereto a specific binding complement of the sbp member;

contacting the support with the sbp member bound to the nanoparticle under conditions effective to allow specific binding interactions to occur between the sbp member and the sb complement bound to the support; and

5 observing a detectable event dependent on the specific binding of the sbp member and the sb complement of the sbp member.

518. The method according to claim 517, wherein the sbp member is biotin.

519. The method according to claim 517, wherein the sb complement is  
10 strepavidin or avidin.

520. A method for detecting a nucleic acid comprising:  
providing a support having oligonucleotides bound thereto, the oligonucleotides bound the support have a sequence that is complementary to a first portion of the nucleic  
15 acid;

contacting the nucleic acid with the support under conditions effective to allow hybridization between the oligonucleotides bound to the support and the first portion of the nucleic acid;

providing an oligonucleotide having a sbp member bound thereto, the  
20 oligonucleotide bound to the sbp member has a sequence that is complementary with the second portion of the nucleic acid;

contacting the nucleic acid bound to the support with the oligonucleotide bound to the sbp member under conditions effective to allow hybridization between the second portion of the nucleic acid bound to the support and the oligonucleotide bound to the sbp  
25 member;

providing an aggregate probe comprising at least two types of nanoparticles having oligonucleotides bound thereto, the nanoparticles of the aggregate probe are bound to each other as a result of the hybridization of some of the oligonucleotides

attached to them, and at least one of the types of nanoparticles of the aggregate probe have some oligonucleotides attached thereto which bound, as a result of hybridization, to oligonucleotides having bound thereto a specific binding complement of said sbp member;

- 5           contacting the sbp member bound to the support with the aggregate probe under conditions effective to allow specific binding interactions between the sbp member bound to the support and specific binding complement bound to the aggregate probe; and  
          observing a detectable change dependent on the specific binding of the sbp member and the sb complement of the sbp member.

10

521.   The method according to claim 520, wherein the sbp member is biotin.

522.   The method according to claim 520, wherein the sb complement is streptavidin or avidin.

15

523.   A method for detecting a nucleic acid comprising:

- providing (i) an aggregate probe comprising at least two types of nanoparticles having oligonucleotides bound thereto, the nanoparticles of the aggregate probe are bound to each other as a result of the hybridization of some of the oligonucleotides  
20   attached to them and at least one of the types of nanoparticles of the aggregate probe have some oligonucleotides attached thereto which are complementary to a first portion of the nucleic acid, and (ii) an oligonucleotide having sbp member, the oligonucleotide having an sbp member bound thereto has a sequence that is complementary to the second portion of the nucleic acid;

25

          contacting the nucleic acid with an aggregate probe under conditions effective to allow hybridization between a portion of the oligonucleotides bound to the aggregate probe with the first portion of the nucleic acid under conditions effective to allow hybridization between the oligonucleotides bound to the aggregate probe with the first

portion of the nucleic acid;

contacting the nucleic acid with an oligonucleotide having sbp member, the oligonucleotide having an sbp member bound thereto has a sequence that is complementary to the second portion of the nucleic acid under conditions effective to  
5 allow hybridization between the oligonucleotides bound the the sbp members with the second portion of the nucleic acid;

providing a support having bound thereto a specific binding complement of the sbp member;

contacting the specific binding complement bound to the support with the sbp  
10 member bound to the aggregate probe under conditions effective to allow specific binding interactions to occur between the sbp member bound to the aggregate probe and the sb complement bound to the support; and

observing a detectable event dependent on the specific binding of the sbp member and the sb complement.

15

524. The method according to claim 523, wherein the sbp member is streptavidin or avidin.

525. The method according to claim 523, wherein the sb complement is biotin.

20

526. The method according to any one of Claims 499-525, wherein the substrate has a plurality of types of oligonucleotides attached to it in an array to allow for the detection of multiple portions of a single nucleic acid, the detection of multiple different nucleic acids, or both.

25

527. The method according to any one of Claims 499-525, wherein the substrate is a transparent substrate or an opaque white substrate.

528. The method according to any one of Claims 499-525, wherein the detectable change is the formation of dark areas on the substrate.

529. The method according to any one of Claims 499-525, wherein the  
5 nanoparticles are made of gold.

530. The method according to any one of Claims 498-523, wherein the substrate is contacted with silver stain to produce the detectable change.

10 531 The method according to any one of Claims 498-523, wherein the detectable change is observed with an optical scanner.

532. A nanoparticle conjugate for detecting an analyte comprising:

- 15 (i) nanoparticles having oligonucleotides bound thereto; and  
(ii) oligonucleotide having bound thereto a specific binding complement of an analyte, the oligonucleotides having the specific binding complement bound thereto have a sequence that is complementary to at least a portion of the oligonucleotides bound to the nanoparticles and are bound, as a result of hybridization, to at least a portion of the oligonucleotides bound to the nanoparticles.

20

533. A nanoparticle conjugate for detecting an analyte comprising:

- (i) nanoparticles having oligonucleotides bound thereto;  
(ii) oligonucleotide having bound thereto a specific binding complement of an analyte member; and  
25 (iii) a linker oligonucleotide having at least two portions, a first portion of the linker oligonucleotide is bound, as a result of hybridization, to the oligonucleotides bound to the nanoparticle and a second portion of the linker oligonucleotide is bound, as a result of hybridization, to the oligonucleotides having bound thereto a specific binding



complement of an analyte.

534. An aggregate probe for detecting an analyte comprising:

- 5 (i) at least two types of nanoparticles having oligonucleotides bound thereto, the nanoparticles of the aggregate probe are bound to each other as a result of the hybridization of some of the oligonucleotides attached to them; and
- (ii) oligonucleotides having bound thereto a specific binding complement of an analyte, the oligonucleotides having the specific binding complement bound thereto are bound, as a result of hybridization, to oligonucleotides of at least one of the types of
- 10 nanoparticles of the aggregate probe.

535. An aggregate probe for detecting an analyte comprising:

- (i) at least two types of nanoparticles having oligonucleotides bound thereto, the nanoparticles of the aggregate probe are bound to each other as a result of the
- 15 hybridization of some of the oligonucleotides attached to them;
- (ii) oligonucleotides having bound thereto a specific binding complement of an analyte; and
- (iii) a linker oligonucleotide having at least two portions, a first portion of the linker oligonucleonucleotide is bound, as a result of hybridization, to oligonucleotides of
- 20 at least one of the types of nanoparticles of the aggregate probe; and a second portion of the linker oligonucleotide is bound, as a result of hybridization, to the oligonucleotides having bound thereto a specific binding complement of an analyte.

536. A method for preparing a nanoprobe conjugate for detecting an analyte

25 comprising:

- providing (i) a nanoparticle conjugate having oligonucleotides bound thereto and (ii) a oligonucleotides having bound thereto a specific binding complement of an analyte, at least a portion of the oligonucleotides bound to the nanoparticles have a sequence that

is complementary to the sequence of the oligonucleotides bound to the specific binding complement, and

contacting the oligonucleotides attached to the nanoparticle conjugate with the oligonucleotides bound to the specific binding complement under conditions effective to  
5 allow hybridization between the oligonucleotides bound to the nanoparticles with the oligonucleotides bound to the specific binding complement.

537. A kit for detecting an analyte comprising

- (a) at least one container holding nanoparticle conjugates comprising (i)  
10 nanoparticles having oligonucleotides bound thereto; and (ii) oligonucleotide having bound thereto a specific binding complement of an analyte, the oligonucleotides having the specific binding pair member have a sequence that is complementary to at least a portion of the oligonucleotides bound to the nanoparticles and are bound, as a result of hybridization, to at least a portion of the oligonucleotides bound to the nanoparticles; and  
15 (b) an optional support for observing a detectable change.

538. A kit for detecting an analyte comprising

- (a) at least one container holding nanoparticle conjugates comprising  
(i) nanoparticles having oligonucleotides bound thereto;  
20 (ii) oligonucleotide having bound thereto a specific binding complement of an analyte member; and  
(iii) a linker oligonucleotide having at least two portions, a first portion of the linker oligonucleotide is bound, as a result of hybridization, to the oligonucleotides bound to the nanoparticle and a second portion of the linker oligonucleotide is bound, as  
25 a result of hybridization, to the oligonucleotides having bound thereto a specific binding complement of an analyte; and  
(b) an optional support for observing a detectable change.

539. A kit for detecting an analyte comprising
- (b) at least one container holding aggregate probes comprising
    - (i) at least two types of nanoparticles having oligonucleotides bound thereto, the nanoparticles of the aggregate probe are bound to each other as a result of the hybridization of some of the oligonucleotides attached to them; and
    - (ii) oligonucleotides having bound thereto a specific binding complement of an analyte, the oligonucleotides having the specific binding complement bound thereto are bound, as a result of hybridization, to oligonucleotides of at least one of the types of nanoparticles of the aggregate probe; and
  - (b) an optional support for observing a detectable change.
540. A kit for detecting an analyte comprising
- (a) at least one container holding aggregate probes comprising
    - (i) at least two types of nanoparticles having oligonucleotides bound thereto, the nanoparticles of the aggregate probe are bound to each other as a result of the hybridization of some of the oligonucleotides attached to them;
    - (ii) oligonucleotides having bound thereto a specific binding complement of an analyte; and
    - (iii) a linker oligonucleotide having at least two portions, a first portion of the linker oligonucleotide is bound, as a result of hybridization, to oligonucleotides of at least one of the types of nanoparticles of the aggregate probe; and a second portion of the linker oligonucleotide is bound, as a result of hybridization, to the oligonucleotides having bound thereto a specific binding complement of an analyte; and
  - (b) an optional support for observing a detectable change.
541. A kit for detecting an analyte comprising:
- (a) at least one container holding a type of nanoparticle conjugates comprising nanoparticles having oligonucleotides bound thereto;

(b) a container holding oligonucleotide having bound thereto a specific binding complement of an analyte, the oligonucleotides having bound thereto the specific binding pair member have a sequence that is complementary to at least a portion of the oligonucleotides bound to the nanoparticles; and

5 (c) an optional support for observing a detectable change.

542. A kit for detecting an analyte comprising

(a) at least one container holding nanoparticle conjugates comprising nanoparticles having oligonucleotides bound thereto;

10 (b) a container holding oligonucleotide having bound thereto a specific binding complement of an analyte member;

(c) a container holding a linker oligonucleotide having at least two portions, a first portion of the linker oligonucleotide is complementary to at least a portion of the oligonucleotides bound to the nanoparticle and a second portion of the linker  
15 oligonucleotide is complementary to the oligonucleotides having bound thereto a specific binding complement of an analyte; and

(d) an optional support for observing a detectable change.

543. A kit for detecting an analyte comprising

20 (a) at least one container holding aggregate probes comprising at least two types of nanoparticles having oligonucleotides bound thereto, the nanoparticles of the aggregate probe are bound to each other as a result of the hybridization of some of the oligonucleotides attached to them;

(b) a container holding oligonucleotides having bound thereto a specific  
25 binding complement of an analyte, the oligonucleotides having bound thereto the specific binding complement are complementary to oligonucleotides of at least one of the types of nanoparticles of the aggregate probe; and

(c) an optional support for observing a detectable change.

544. A kit for detecting an analyte comprising

(a) at least one container holding aggregate probes comprising at least two types of nanoparticles having oligonucleotides bound thereto, the nanoparticles of the aggregate probe are bound to each other as a result of the hybridization of some of the oligonucleotides attached to them;

(b) a container holding oligonucleotides having bound thereto a specific binding complement of an analyte;

(c) a container holding a linker oligonucleotide having at least two portions, a first portion of the linker oligonucleotide has a sequence that is complementary to oligonucleotides of at least one of the types of nanoparticles of the aggregate probe; and a second portion of the linker oligonucleotide has a sequence that is complementary to the oligonucleotides having bound thereto a specific binding complement of an analyte; and

(d) an optional support for observing a detectable change.

545. A kit for detecting an analyte comprising:

(a) at least one container holding a type of nanoparticle conjugates comprising nanoparticles having oligonucleotides bound thereto;

(b) a container holding oligonucleotide having covalently bound thereto a functional group for binding a specific binding complement of an analyte, the oligonucleotides having the bound functional group have a sequence that is complementary to at least a portion of the oligonucleotides bound to the nanoparticles; and

(c) an optional support for observing a detectable change.

546. A kit for detecting an analyte comprising

(a) at least one container holding nanoparticle conjugates comprising

nanoparticles having oligonucleotides bound thereto;

(b) a container holding oligonucleotide having covalently bound thereto a functional group for binding a specific binding complement of an analyte;

(c) a container holding a linker oligonucleotide having at least two portions, a  
5 first portion of the linker oligonucleotide is complementary to at least a portion of the oligonucleotides bound to the nanoparticle and a second portion of the linker oligonucleotide is complementary to the oligonucleotides having the bound functional group; and

(d) an optional support for observing a detectable change.

10

547. A kit for detecting an analyte comprising

(a) at least one container holding aggregate probes comprising at least two types of nanoparticles having oligonucleotides bound thereto, the nanoparticles of the aggregate probe are bound to each other as a result of the hybridization of  
15 some of the oligonucleotides attached to them;

(b) a container holding oligonucleotide having covalently bound thereto a functional group for binding a specific binding complement of an analyte, the oligonucleotides having the functional group have a sequence that is complementary to oligonucleotides of at least one of the types of nanoparticles of the aggregate probe; and

(c) an optional support for observing a detectable change.

20

548. A kit for detecting an analyte comprising

(a) at least one container holding aggregate probes comprising at least two types of nanoparticles having oligonucleotides bound thereto, the nanoparticles of the aggregate probe are bound to each other as a result of the hybridization of  
25 some of the oligonucleotides attached to them;

(b) a container holding oligonucleotide having covalently bound thereto a functional group for binding a specific binding complement of an analyte;

- (c) a container holding a linker oligonucleotide having at least two portions, a first portion of the linker oligonucleotide has a sequence that is complementary to oligonucleotides of at least one of the types of nanoparticles of the aggregate probe; and a second portion of the linker oligonucleotide has a sequence that is complementary to the oligonucleotides having the functional group bound thereto; and
- 5 (d) an optional support for observing a detectable change.

549. A kit for detecting an analyte comprising:

- a substrate having oligonucleotides attached thereto;
- 10 an oligonucleotide having a covalently bound thereto a functional group for binding a specific binding complement of an analyte, the oligonucleotide bound to the functional group having a sequence that is complementary to the oligonucleotides bound to the substrate; and
- a nanoparticle conjugate comprising (i) nanoparticles having
- 15 oligonucleotides bound thereto; and (ii) oligonucleotide having bound thereto a specific binding complement of an analyte, the oligonucleotides having bound thereto the specific binding complement have a sequence that is complementary to at least a portion of the oligonucleotides bound to the nanoparticles and are bound, as a result of hybridization, to at least a portion of the oligonucleotides bound to the nanoparticles.

20

550. A kit for detecting an analyte comprising:

- a substrate having oligonucleotides attached thereto;
- an oligonucleotide having a covalently bound thereto a functional group for binding a specific binding complement of an analyte, the oligonucleotide bound to the functional group having a sequence that is complementary to the oligonucleotides
- 25 bound to the substrate; and
- nanoparticle conjugates comprising (i) nanoparticles having oligonucleotides bound thereto; (ii) oligonucleotide having bound thereto a specific

binding complement of the sbp member; and (iii) a linker oligonucleotide having at least two portions, a first portion of the linker oligonucleotide is bound, as a result of hybridization, to the oligonucleotides bound to the nanoparticle and a second portion of the linker oligonucleotide is bound, as a result of hybridization, to the oligonucleotides  
5 having bound thereto a specific binding complement of an analyte.

551. A kit for detecting a nucleic acid comprising:  
a substrate having oligonucleotides attached thereto, the oligonucleotides bound to the substrate have a sequence that is complementary to a first portion of the  
10 nucleic acid;  
an oligonucleotide having an sbp member bound thereto, the oligonucleotide having a sequence that is complementary to a second portion of the nucleic acid; and  
a nanoparticle conjugate comprising (i) nanoparticles having  
15 oligonucleotides bound thereto; and (ii) oligonucleotide having bound thereto a specific binding complement of an sbp member, the oligonucleotides having bound thereto the specific binding complement have a sequence that is complementary to at least a portion of the oligonucleotides bound to the nanoparticles and are bound, as a result of hybridization, to at least a portion of the oligonucleotides bound to the nanoparticles.

20

552. The kit according to claim 551 wherein the sbp member is biotin.

553. The kit according to claim 551 wherein the specific binding complement of the sbp member is streptavidin or avidin.

25

554. A kit for detecting a nucleic acid comprising:  
a substrate having oligonucleotides attached thereto, the oligonucleotides bound to the substrate have a sequence that is complementary to a first portion of the nucleic



acid;

a oligonucleotide having an sbp member bound thereto, the oligonucleotide having the bound sbp member having a sequence that is complementary to a second portion of the nucleic acid; and

- 5 nanoparticle conjugates comprising (i) nanoparticles having oligonucleotides bound thereto; (ii) oligonucleotide having bound thereto a specific binding complement of the sbp member; and (iii) a linker oligonucleotide having at least two portions, a first portion of the linker oligonucleotide is bound, as a result of hybridization, to the oligonucleotides bound to the nanoparticle and a second portion of the linker  
10 oligonucleotide is bound, as a result of hybridization, to the oligonucleotides having bound thereto a specific binding complement of an analyte.

555. The kit according to claim 554, wherein the sbp member is biotin.

- 15 556. The kit according to claim 554, wherein the specific binding complement of the sbp member is streptavidin or avidin.

557. A kit for detecting an analyte comprising:

a substrate having oligonucleotides attached thereto;

- 20 an oligonucleotide having a covalently bound thereto a functional group for binding an analyte, the oligonucleotide bound to the functional group having a sequence that is complementary to the oligonucleotides bound to the substrate; and

- an aggregate probe comprising: (i) at least two types of nanoparticles having oligonucleotides bound thereto, the nanoparticles of the aggregate probe are bound to  
25 each other as a result of the hybridization of some of the oligonucleotides attached to them; and (ii) oligonucleotides having bound thereto a specific binding complement of an analyte, the oligonucleotides having bound thereto a specific binding complement of an analyte are further bound, as a result of hybridization, to oligonucleotides of at least

one of the types of nanoparticles of the aggregate probe.

558. A kit for detecting an analyte comprising:

a substrate having oligonucleotides attached thereto;

5 an oligonucleotide having a covalently bound thereto a functional group for binding an analyte, the oligonucleotide bound to the functional group having a sequence that is complementary to the oligonucleotides bound to the substrate; and

an aggregate probe comprising: (i) at least two types of nanoparticles having oligonucleotides bound thereto, the nanoparticles of the aggregate probe are bound to  
10 each other as a result of the hybridization of some of the oligonucleotides attached to them; (ii) oligonucleotides having bound thereto a specific binding complement of an analyte; and (iii) a linker oligonucleotide having at least two portions, a first portion of the linker oligonucleotide is bound, as a result of hybridization, to oligonucleotides of at least one of the types of nanoparticles of the aggregate probe; and a second portion  
15 of the linker oligonucleotide is bound, as a result of hybridization, to the oligonucleotides having bound thereto a specific binding complement of an analyte.

559. A kit for detecting a nucleic acid comprising:

a substrate having oligonucleotides attached thereto, the oligonucleotides  
20 bound to the substrate have a sequence that is complementary to a first portion of the nucleic acid;

an oligonucleotide having an sbp member bound thereto, the oligonucleotide having a sequence that is complementary to a second portion of the nucleic acid; and

25 an aggregate probe for detecting an analyte comprising: (i) at least two types of nanoparticles having oligonucleotides bound thereto, the nanoparticles of the aggregate probe are bound to each other as a result of the hybridization of some of the oligonucleotides attached to them; and (ii) oligonucleotides having bound thereto a

specific binding complement of the sbp member, the oligonucleotides having bound thereto a specific binding complement are bound, as a result of hybridization, to oligonucleotides of at least one of the types of nanoparticles of the aggregate probe.

5           560.   The kit according to claim 559 wherein the sbp member is biotin.

          561.   The kit according to claim 559 wherein the specific binding complement of the sbp member is streptavidin or avidin.

10           562.   A kit for detecting a nucleic acid comprising:

          a substrate having oligonucleotides attached thereto, the oligonucleotides bound to the substrate have a sequence that is complementary to a first portion of the nucleic acid;

          a oligonucleotide having an sbp member bound thereto, the oligonucleotide  
15   having the bound sbp member having a sequence that is complementary to a second portion of the nucleic acid; and

          aggregate probes comprising (i) at least two types of nanoparticles having oligonucleotides bound thereto, the nanoparticles of the aggregate probe are bound to each other as a result of the hybridization of some of the oligonucleotides attached to  
20   them; (ii) oligonucleotides having bound thereto a specific binding complement of an analyte; and (iii) a linker oligonucleotide having at least two portions, a first portion of the linker oligonucleotide is bound, as a result of hybridization, to oligonucleotides of at least one of the types of nanoparticles of the aggregate probe; and a second portion of the linker oligonucleotide is bound, as a result of hybridization, to the oligonucleotides  
25   having bound thereto a specific binding complement of an sbp member.

          563.   The kit according to claim 562 wherein the sbp member is biotin.

564. The kit according to claim 562 wherein the specific binding complement of the sbp member is streptavidin or avidin.

565. A method for nanofabrication comprising:

- 5 providing at least one type of linking oligonucleotide having a selected sequence, the sequence of each type of linking oligonucleotide having at least two portions;
- providing one or more types of nanoparticles having oligonucleotides attached thereto, the oligonucleotides on each type of nanoparticles having a sequence complementary to a first portion of the sequence of a linking oligonucleotide;
- 10 providing a complex comprised of streptavidin or avidin bound to two or more biotin molecules, each having an oligonucleotide bound thereto, the oligonucleotides bound to the biotin molecules have a sequence complementary to a second portion of the sequence of the linking oligonucleotide; and
- contacting the linking oligonucleotides, complex, and nanoparticles under
- 15 conditions effective to allow hybridization of the oligonucleotides on the nanoparticles and the first oligonucleotides bound to the biotin to the linking oligonucleotides so that a desired nanomaterials or nanostructure is formed.

566. A method of nanofabrication comprising:

- 20 providing (i) at least one type of linking oligonucleotide having a selected sequence, the sequence of each type of linking oligonucleotide having at least two portions; (ii) at least two types of nanoparticles having oligonucleotides attached thereto, the oligonucleotides on the first type of nanoparticles have a sequence complementary to that of the oligonucleotides on the second type of nanoparticles and a sequence that is
- 25 complementary to the first portion of the sequence of the linking oligonucleotides, the oligonucleotides on the second type of nanoparticles have a sequence complementary to that of the oligonucleotides on the first type of nanoparticle-oligonucleotide conjugates and a sequence that is complementary to the first portion of the sequence of the linking

oligonucleotide; and (iii) a complex comprised of streptavidin or avidin bound to two or more biotin molecules, each having an oligonucleotide bound thereto, the oligonucleotide bound to the biotin molecule has a sequence that is complementary to the second portion of the linking oligonucleotide; and

5           contacting the first and second types of nanoparticles, the linking oligonucleotides, and the complex under conditions effective to allow hybridization of the oligonucleotides on the nanoparticles to each other and to the linking oligonucleotide and the hybridization of the oligonucleotides of the complexes to the linking oligonucleotides so that a desired nanomaterials or nanostructure is formed.

10

567. A method of nanofabrication comprising:

          providing (a) at least one type of linking oligonucleotide having a selected sequence, the sequence of each type of linking oligonucleotide having at least two portions; (b) one or more types of nanoparticles having oligonucleotides attached thereto, the oligonucleotides on each type of nanoparticles having a sequence complementary to a first portion of the sequence of a linking oligonucleotide; (c) biotin having a oligonucleotide bound thereto, the oligonucleotide bound to the biotin has a sequence complementary to a second portion of the sequence of the linking oligonucleotide; and (d) streptavidin or avidin;

20           contacting the linking oligonucleotides, biotin having an oligonucleotide bound thereto, and nanoparticles under conditions effective to allow hybridization of the oligonucleotides on the nanoparticles and the oligonucleotides bound to the biotin to the linking oligonucleotides to produce a complex; and

          contacting the complex with streptavidin or avidin under conditions effective to allow specific binding interaction between biotin and streptavidin or avidin so that a desired nanomaterials or nanostructure is formed.

25

568. A nanomaterial produced by the method comprising:

providing (i) at least one type of linking oligonucleotide having a selected sequence, the sequence of each type of linking oligonucleotide having at least two portions; (ii) at least two types of nanoparticles having oligonucleotides attached thereto, the oligonucleotides on the first type of nanoparticles have a sequence complementary to that of the oligonucleotides on the second type of nanoparticles and a sequence that is complementary to the first portion of the sequence of the linking oligonucleotides, the oligonucleotides on the second type of nanoparticles have a sequence complementary to that of the oligonucleotides on the first type of nanoparticle-oligonucleotide conjugates and a sequence that is complementary to the first portion of the sequence of the linking oligonucleotide; and (iii) a complex comprised of streptavidin or avidin bound to two or more biotin molecules, each having an oligonucleotide bound thereto, the oligonucleotide bound to the biotin molecule has a sequence that is complementary to the second portion of the linking oligonucleotide; and

contacting the first and second types of nanoparticles, the linking oligonucleotides, and the complex under conditions effective to allow hybridization of the oligonucleotides on the nanoparticles to each other and to the linking oligonucleotide and the hybridization of the oligonucleotides of the complexes to the linking oligonucleotides so that a desired nanomaterials or nanostructure is formed.

20 569. A nanomaterial produced by the method comprising:

providing (a) at least one type of linking oligonucleotide having a selected sequence, the sequence of each type of linking oligonucleotide having at least two portions; (b) one or more types of nanoparticles having oligonucleotides attached thereto, the oligonucleotides on each type of nanoparticles having a sequence complementary to a first portion of the sequence of a linking oligonucleotide; (c) biotin having a oligonucleotide bound thereto, the oligonucleotide bound to the biotin has a sequence complementary to a second portion of the sequence of the linking oligonucleotide; and (d) streptavidin or avidin;

contacting the linking oligonucleotides, biotin having an oligonucleotide bound thereto, and nanoparticles under conditions effective to allow hybridization of the oligonucleotides on the nanoparticles and the oligonucleotides bound to the biotin to the linking oligonucleotides to produce a complex; and

5 contacting the complex with streptavidin or avidin under conditions effective to allow specific binding interaction between biotin and streptavidin or avidin so that a desired nanomaterials or nanostructure is formed.

570. A method of separating a selected target nucleic acid having at least two  
10 portions from other nucleic acids comprising:

providing (a) one or more types of nanoparticles having oligonucleotides attached thereto, the oligonucleotides on each of the types of nanoparticles having a sequence complementary to the sequence of the first portion of the selected nucleic acid; (b) a  
15 complex comprised of streptavidin or avidin bound to two or more biotin molecules, each having a first oligonucleotide bound thereto, the first oligonucleotide having a sequence complementary to the sequence of the second portion of the selected nucleic acid;

contacting the selected nucleic acid and other nucleic acids with the nanoparticles under conditions effective to allow hybridization of the oligonucleotides on the nanoparticles and the first oligonucleotides of the complex with the selected nucleic acid  
20 and subsequent formation of an aggregate; and

separating out the aggregate including the selected nucleic acid.

571. A method of separating a selected nucleic acid having at least two portions from other nucleic acids comprising:

25 providing (a) one or more types of nanoparticles having oligonucleotides attached thereto, the oligonucleotides on each of the types of nanoparticles having a sequence complementary to the sequence of the first portion of the selected nucleic acid; (b) biotin having a oligonucleotide bound thereto, the oligonucleotide having a sequence

complementary to the sequence of the second portion of the selected nucleic acid; and (c) streptavidin or avidin;

contacting the selected nucleic acid and other nucleic acids with the nanoparticles and biotin having oligonucleotides bound thereto under conditions effective to allow  
5 hybridization of the oligonucleotides on the nanoparticles and the oligonucleotides of the biotin construct with the selected nucleic acid and produce a complex;

contacting the complex with streptavidin or avidin under conditions effective to allow specific binding interactions between the biotin and streptavidin or avidin and subsequent formation of an aggregate; and

10 separating out the aggregate including the selected nucleic acid.

572. A method for accelerating movement of a nanoparticle to an electrode surface comprising the steps of:

providing at least one type of nanoparticle bound to a charged first member of a specific binding pair and an electrode surface including a second member of a specific  
15 binding pair;

contacting the nanoparticle and the surface under conditions effective to allow binding between the first and the second members of the specific binding pair; and

subjecting the nanoparticle to an electrical field so as to accelerate movement of the nanoparticle to the surface and facilitate binding between the first and second  
20 members of the binding pair.

573. The method of claim 572 wherein the specific binding pair comprises an antibody/antigen.

574. The method of claim 572 wherein the specific binding pair comprises a receptor/ligand.

25 575. A method of detecting a nucleic acid bound to an electrode surface, the nucleic acid having one or more portions comprising:

providing one or more types of nanoparticles having oligonucleotides attached thereto, the oligonucleotides on each of the types of nanoparticles having a sequence



complementary to the sequence of one of the portions of the nucleic acid;

contacting the nucleic acid and the nanoparticles under conditions effective to allow hybridization of the oligonucleotides on the nanoparticles with the nucleic acid;

5       subjecting the nanoparticle to an electrical field so as to accelerate movement of the nanoparticle to the surface; and

observing a detectable change.

576. The method according to claim 575 wherein the nucleic acid has a least two portions.

577. A method of detecting nucleic acid bound to a surface, the nucleic acid  
10       having at one or more portions comprising:

contacting the nucleic acid with at least two types of nanoparticles having oligonucleotides attached thereto, the oligonucleotides on the first type of nanoparticles having a sequence complementary to a first portion of the sequence of the nucleic acid, the oligonucleotides on the second type of nanoparticles having a sequence

15       complementary to a second portion of the sequence of the nucleic acid, the contacting taking place under conditions effective to allow hybridization of the oligonucleotides on the nanoparticles with the nucleic acid;

subjecting the nanoparticle to an electrical field so as to accelerate movement of the nanoparticle to the surface; and

20       observing a detectable change brought about by hybridization of the oligonucleotides on the nanoparticles with the nucleic acid.

578. The method according to claim 577 wherein the nucleic acid has at least two portions.

25

579. The method of Claim 577 wherein the contacting conditions include freezing and thawing.

580. The method of Claim 577 wherein the contacting conditions include heating.

581. The method of Claim 577 wherein the detectable change is observed on a solid surface.

5

582. The method of Claim 577 wherein the detectable change is a color change observable with the naked eye.

583. The method of Claim 582 wherein the color change is observed on a solid surface.

10

584. The method of Claim 577 wherein the nanoparticles are made of gold.

585. The method of Claim 577 wherein the nanoparticles are metallic or semiconductor nanoparticles and the oligonucleotides attached to the nanoparticles are labeled with

15 fluorescent molecules on the ends not attached to the nanoparticles.

586. The method according to claim 577 wherein the nucleic acid has at least two portions.

587. The method of Claim 586 wherein:

20

the nucleic acid has a third portion located between the first and second portions, and the sequences of the oligonucleotides on the nanoparticles do not include sequences complementary to this third portion of the nucleic acid; and

the nucleic acid is further contacted with a filler oligonucleotide having a sequence complementary to this third portion of the nucleic acid, the contacting taking place under

25

conditions effective to allow hybridization of the filler oligonucleotide with the nucleic acid.

588. The method of Claim 577 wherein the nucleic acid is viral RNA or DNA.

589. The method of Claim 577 wherein the nucleic acid is a gene associated with a disease.

5 590. The method of Claim 577 wherein the nucleic acid is a bacterial DNA.

591. The method of Claim 577 wherein the nucleic acid is a fungal DNA.

592. The method of Claim 577 wherein the nucleic acid is a synthetic DNA, a synthetic  
10 RNA, a structurally modified natural or synthetic RNA, or a structurally modified natural or synthetic DNA.

593. The method of Claim 577 wherein the nucleic acid is from a biological source.

15 594. The method of Claim 577 wherein the nucleic acid is a product of a polymerase chain reaction amplification.

595. The method of Claim 577 wherein the nucleic acid is a fragment obtained by cleavage of DNA with a restriction enzyme.

20

596. The method of Claim 577 wherein the nucleic acid is contacted with the first and second types of nanoparticles simultaneously.

25 597. The method of Claim 577 wherein the nucleic acid is contacted and hybridized with the oligonucleotides on the first type of nanoparticles before being contacted with the second type of nanoparticles.

598. The method of Claim 597 wherein the first type of nanoparticles is attached to a

substrate.

598. The method according to claim 575 or 577 wherein the detectable change is brought about by hybridization of the oligonucleotides on the nanoparticles with the  
5 nucleic acid.

599. A method of detecting nucleic acid in a sample, the nucleic acid having at least two portions, said method comprising:

10 providing a substrate having oligonucleotides attached thereto, the oligonucleotides having a sequence complementary to a first portion of the sequence of a nucleic acid to be detected;

15 providing a scattered light detectable nanoparticle probe having oligonucleotides attached thereto, the oligonucleotides bound to the nanoparticle probe having a sequence complementary to a second portion of the sequence of said nucleic acid wherein the oligonucleotides are attached to the nanoparticles in a stepwise ageing process comprising (i) contacting the oligonucleotides with the nanoparticles in a first aqueous solution for a period of time sufficient to allow some of the oligonucleotides to bind to the nanoparticles; (ii) adding at least one salt to the aqueous solution to create a second aqueous solution; and (iii) contacting the oligonucleotides and nanoparticles in  
20 the second aqueous solution for an additional period of time to enable additional oligonucleotides to bind to the nanoparticles;

25 contacting said nucleic acid, the substrate and the nanoparticle probe under conditions effective to allow hybridization of said nucleic acid with the oligonucleotides on the nanoparticle probe and with the oligonucleotides on the substrate and form a light scattering complex bound to the substrate;

illuminating the light scattering complex under conditions effective to produce scattered light from said complex; and

detecting the light scattered by said complex under said conditions as a

measure of the presence of the nucleic acid.

600. The method of Claim 599 wherein said nucleic acid is contacted with the substrate so that said nucleic acid hybridizes with the oligonucleotides on the substrate,  
5 and said nucleic acid bound to the substrate is then contacted with the scattered light detectable nanoparticle probe so that said nucleic acid hybridizes with the oligonucleotides on the nanoparticle probe.

601. The method of Claim 599 wherein said nucleic acid is contacted with the  
10 nanoparticle probe so that said nucleic acid hybridizes with the oligonucleotides on the nanoparticle probe, and said nucleic acid bound to the nanoparticle probe is then contacted with the substrate so that said nucleic acid hybridizes with the oligonucleotides on the substrate.

15 602. The method of Claim 599 wherein said nucleic acid is contacted simultaneously with the nanoparticle probe and the substrate.

603. The method of Claim 599 wherein the substrate has a plurality of types of oligonucleotides attached to it in an array to allow for the detection of multiple portions  
20 of a single nucleic acid, the detection of multiple different nucleic acids, or both.

604. The method according to Claim 599 wherein said substrate is a waveguide comprising (a) a transparent element having a refractive index greater than that of the fluid sample; (b) a light receiving edge; and (c) a surface having oligonucleotides bound  
25 thereto.

605. The method according to claim 604 wherein the illuminating is performed at the light receiving edge of the waveguide with light effective to create total internal

reflection within the waveguide, thereby simulataneously illuminating the entire surface of the waveguide.

606. The method according to claim 603, wherein a plurality of different types  
5 of nanoparticles with different sizes or compositions or both are distinguishably detected, each type of nanoparticles specifically associating with a different nucleic acid sequence.

607. A method of detecting two or more nucleic acids in a sample, each nucleic acid having at least two portions, the method comprising:

10 providing a substrate having two or more types of oligonucleotides attached thereto, each type of oligonucleotides attached to a different place on the substrate and each type of oligonucleotides having sequences complementary to a first portion of the sequences of one of nucleic acids to be detected;

15 providing two or more types of scattered light detectable nanoparticle probes, each type of nanoparticle probes having the oligonucleotides bound thereto, the oligonucleotides bound to each type of probe have a sequence that are complementary to a second portion of the sequence of one of said nucleic acids to be detected, wherein the oligonucleotides are attached to the nanoparticles in a stepwise ageing process comprising (i) contacting the oligonucleotides with the nanoparticles in a first aqueous  
20 solution for a period of time sufficient to allow some of the oligonucleotides to bind to the nanoparticles; (ii) adding at least one salt to the aqueous solution to create a second aqueous solution; and (iii) contacting the oligonucleotides and nanoparticles in the second aqueous solution for an additional period of time to enable additional oligonucleotides to bind to the nanoparticles;

25 contacting said nucleic acids, the substrate and the nanoparticle probes under conditions effective to allow hybridization of said nucleic acids with the oligonucleotides on the nanoparticle probes and with the oligonucleotides on the substrate to form a light scattering complex bound to the substrate;

illuminating the light scattering complex under conditions effective to produce scattered light from said complex; and

detecting the light scattered by said complex under said conditions as a measure of the presence of one or more nucleic acids.

5

608. The method of Claim 607 wherein said nucleic acids are contacted with the substrate so that said nucleic acids hybridize with the oligonucleotides on the substrate, and said nucleic acids bound to the substrate are then contacted with the scattered light detectable nanoparticle probes so that said nucleic acids selectively hybridize with the  
10 oligonucleotides on the nanoparticle probes.

609. The method of Claim 607 wherein said nucleic acids are contacted with the nanoparticle probes so that said nucleic acids hybridize with the oligonucleotides on the nanoparticle probes, and said nucleic acids bound to the nanoparticle probes are then  
15 contacted with the substrate so that said nucleic acids hybridize with the oligonucleotides on the substrate.

610. The method of Claim 607 wherein said nucleic acids are contacted simultaneously with the nanoparticle probes and the substrate.

20

611. The method of Claim 607 wherein the substrate has a plurality of types of oligonucleotides attached to it in an array to allow for the detection of multiple portions of a single nucleic acid, the detection of multiple different nucleic acids, or both.

25 612. The method according to Claim 607 wherein said substrate is a waveguide comprising (a) a transparent element having a refractive index greater than that of the fluid sample; (b) a light receiving edge; and (c) a surface having oligonucleotides bound thereto.

613. The method according to claim 612 wherein the illuminating is performed at the light receiving edge of the waveguide with light effective to create total internal reflection within the waveguide, thereby simultaneously illuminating the entire surface of  
5 the waveguide.

614. The method of Claims 599 or 607 wherein the nanoparticles are metal nanoparticles or semiconductor nanoparticles.

10 615. The method of claim 16 wherein the nanoparticles are gold nanoparticles.

616. The method of Claims 599 or 607 wherein the oligonucleotides to be bound to the nanoparticles have covalently bound thereto a moiety comprising a functional group that can bind to the nanoparticles.

15

617. The method of Claims 599 or 607 wherein the moiety comprises a thiol, a polythiol, or a cyclic disulfide group.

20 618. The method of Claims 599 or 607 wherein all of the salt is added to the first aqueous solution in a single addition.

619. The method of Claims 599 or 607 wherein the salt is added gradually over time.

25 620. The method of Claims 599 or 607 wherein the salt is selected from the group consisting of sodium chloride, magnesium chloride, potassium chloride, ammonium chloride, sodium acetate, ammonium acetate, lithium chloride, tetramethylammonium chloride, a combination of two or more of these salts, one of these



salts in a phosphate buffer, and a combination of two or more of these salts in a phosphate buffer.

621. The method of claim 619 wherein the salt is sodium chloride in a  
5 phosphate buffer.

622. The method of Claims 599 or 607 wherein the nanoparticles have a diameter ranging between about 10 and about 100 nm.

10 623. The method of Claims 599 or 607 wherein the nanoparticles have a diameter of about 50 nm.

624. The method of Claims 599 or 607 wherein the nanoparticles have a diameter of about 100 nm.

15 625. The method of Claims 599 or 607 wherein two scattered light detectable nanoparticle probes of different diameters are used.

626. The method of claim 624 wherein the nanoparticle probes have a diameter  
20 of 50 nm and 100 nm.

627. A method for detecting a nucleic acid, the sequence of the nucleic acid having at least two portions, the method comprising:

25 providing a substrate having oligonucleotides bound thereto, the oligonucleotides bound to the substrate have a sequence that is complementary to a first portion of a sequence of a nucleic acid;

providing labels having oligonucleotides bound thereto, at least some of the oligonucleotides having a sequence that is complementary to the sequence of a second

portion of the nucleic acid;

contacting the substrate, nucleic acid, and labels, the contacting taking place under conditions effective to allow hybridization between the oligonucleotides bound to the substrate with the nucleic acids and between the nucleic acid and the oligonucleotide  
5 bound to the label so as to form a test substrate having labels complexed thereto;

contacting the test substrate with an aqueous salt solution having a salt concentration effective to substantially remove non-specifically bound labels; and  
observing a detectable change.

10 628. The method of Claim 627 wherein the nucleic acid is contacted with the substrate provided in (a) prior to contacting it with the labels.

629. The method of Claim 627 wherein the nucleic acid is contacted with the labels provided in (b) prior to contacting it with the substrate.

15

630. The method of Claim 627 wherein the label is detected with a silver stain.

631. The method according to Claim 627 wherein the nucleic acid is RNA or DNA.

20

632. The method according to Claim 627 wherein the nucleic acid is human, bacterial or viral or fungal origin.

25 633. The method according to Claim 627 wherein the nucleic acid is a gene associated with a disease.

634. The method of Claim 627 wherein the nucleic acid is a synthetic DNA, a synthetic RNA, a structurally-modified natural or synthetic RNA, or a structurally-

modified natural or synthetic DNA.

635. The method of Claim 627 wherein the nucleic acid is a product of a polymerase chain reaction amplification.

5

636. The method of Claim 627 wherein the labels are made of metal.

637. The method of Claim 627 wherein the labels comprise nanoparticles.

10 638. The method of Claim 627 wherein the labels comprise metallic or semiconductor nanoparticles.

639. The method of Claim 638 wherein the labels comprise gold nanoparticles.

15 640. The method of Claim 627 wherein the substrate has a plurality of types of oligonucleotides attached to it in an array to allow for the detection of multiple portions of a single nucleic acid, the detection of multiple different nucleic acids, or both.

20 641. The method of Claim 627 wherein the substrate is contacted with silver stain to produce the detectable change.

25 642. The method of Claim 627 wherein the oligonucleotides attached to the substrate are located between two electrodes, the labels of the conjugates are made of a material which is a conductor of electricity, and the detectable change is a change in an electrical property of the electrodes.

643. The method of Claim 642 wherein the change in the electrical property of

the electrodes include a change in conductivity, resistivity, capacitance, or impedance.

644. The method of Claim 642 wherein the electrodes are made of gold, and the labels are made of gold.

5

645. The method of Claim 642 wherein the test substrate is contacted with silver stain to produce the change in conductivity.

646. The method of Claim 642 wherein the test substrate is contacted with a material to produce a change in the electrical properties between the electrodes.

10

647. The method of Claim 627 wherein the aqueous salt solution comprises a salt selected from the group consisting of sodium chloride, magnesium chloride, potassium chloride, ammonium chloride, sodium acetate, ammonium acetate, a combination of two or more of these salts, one of these salts in a phosphate buffer, and a combination of two or more of these salts in a phosphate buffer.

15

648. The method of Claim 647 wherein the salt solution is sodium chloride in a phosphate buffer.

20

649. The method of Claim 648 wherein the aqueous salt solution comprises between about 0 M to 0.5 M sodium chloride and between about 0.01 mM to 15 mM phosphate buffer at pH 7.

25

650. The method of Claim 648 wherein the aqueous salt solution comprises between about 0.005 to 0.1 M sodium chloride and about 10 mM phosphate buffer at pH 7.

651. Method of detecting a nucleic acid having at least two portions comprising:

- 5 (a) contacting a nucleic acid with a substrate having oligonucleotides attached thereto, the oligonucleotides being located between a pair of electrodes, the oligonucleotides having a sequence complementary to a first portion of the sequence of said nucleic acid, the contacting taking place under conditions effective to allow hybridization of the oligonucleotides on the substrate with said nucleic acid;
- 10 (b) contacting said nucleic acid bound to the substrate with a first type of labels, the labels being made of a material which can conduct electricity, the labels having one or more types of oligonucleotides attached thereto, at least one of the types of oligonucleotides having a sequence complementary to a second portion of the sequence of said nucleic acid, the contacting taking place under conditions effective to allow hybridization of the oligonucleotides on the labels with said nucleic acid so as to form a test substrate having labels complexed thereto;
- 15 (c) contacting the test substrate with an aqueous salt solution having a salt concentration effective to sufficiently remove non-specifically bound labels; and
- (d) detecting an observable change.

20 652. The method of Claim 651 wherein detecting an observable change includes detecting a change in an electrical property between the electrodes and the change in the electrical property of the electrodes include a change in conductivity, resistivity, capacitance, or impedance.

25 653. The method of Claim 651 wherein the substrate has a plurality of pairs of electrodes located on it in an array to allow for the detection of multiple portions of a single nucleic acid, the detection of multiple different nucleic acids, or both, each of the pairs of electrodes having a type of oligonucleotides attached to the substrate between

them.

654. The method of Claim 651 wherein the labels are made of metal.

5 655. The method of Claim 651 wherein the labels comprise nanoparticles.

656. The method of Claim 651 wherein the labels comprise metallic or semiconductor nanoparticles.

10 657. The method of Claim 651 wherein the labels comprise gold nanoparticles.

658. The method of Claim 651 wherein the substrate is contacted with silver stain to produce the change in conductivity.

15 659. The method of Claim 651 further comprising:

(d) contacting the first type of labels bound to the substrate with a second type of labels, the labels being made of a material which can conduct electricity, the labels having oligonucleotides attached thereto, at least one of the types of oligonucleotides on the second type of labels comprising a sequence complementary to the sequence of one of the types of oligonucleotides on the first type of labels, the contacting taking place under conditions effective to allow hybridization of the oligonucleotides on the first and second types of labels; and

(e) detecting the change in an electrical property of the electrodes.

25 660. The method of Claim 659 wherein the change in an electrical property of the electrodes include a change in conductivity, resistivity, capacitance, or impedance.

661. The method of Claim 659 wherein at least one of the types of

oligonucleotides on the first type of labels has a sequence complementary to the sequence of at least one of the types of oligonucleotides on the second type of labels and the method further comprises:

- 5 (f) contacting the second type of labels bound to the substrate with the first type of labels, the contacting taking place under conditions effective to allow hybridization of the oligonucleotides on the first and second types of labels; and
- (g) detecting the change in an electrical property of the electrodes.

662. The method of Claim 661 wherein the change in the electrical property of  
10 the electrodes include a change in conductivity, resistivity, capacitance, or impedance.

663. The method of Claim 661 wherein step (d) or steps (d) and (f) are repeated one or more times and the change in conductivity is detected.

15 664. The method of Claim 651 further comprising:

- (d) contacting the first type of labels bound to the substrate with an aggregate probe having oligonucleotides attached thereto, the labels of the aggregate probe being made of a material which can conduct electricity, at least one of the types of oligonucleotides on the aggregate probe comprising a sequence complementary to the  
20 sequence of one of the types of oligonucleotides on the first type of labels, the contacting taking place under conditions effective to allow hybridization of the oligonucleotides on the aggregate probe with the oligonucleotides on the first type of labels; and
- (e) detecting the change in an electrical property of the electrodes.

25 665. The method of Claim 664 wherein the change in the electrical property of the electrodes include a change in conductivity, resistivity, capacitance, or impedance.

666. The method of Claim 651 wherein the aqueous salt solution comprises a

salt selected from the group consisting of sodium chloride, magnesium chloride, potassium chloride, ammonium chloride, sodium acetate, ammonium acetate, a combination of two or more of these salts, one of these salts in a phosphate buffer, and a combination of two or more of these salts in a phosphate buffer.

5

667. The method of Claim 666 wherein the salt solution is sodium chloride in a phosphate buffer.

668. The method of Claim 667 wherein the aqueous salt solution comprises  
10 between about 0 M to 0.5 M sodium chloride and between about 0.01 mM to 15 mM phosphate buffer at pH 7.

669. The method of Claim 667 wherein the aqueous salt solution comprises  
15 between about 0.005 to 0.1 M sodium chloride and about 10 mM phosphate buffer at pH 7.

670. In a method for increasing stringency of hybridization that employs a substrate having bound capture oligonucleotide probes and labeled oligonucleotide detection probes for capturing and detecting one or more target nucleic acids in a sample  
20 by hybridization interactions, the sample including nucleic acids having a mismatched base, the improvement comprising including a step of washing the substrate having a hybridized complex of capture probes, target nucleic acid, and detection probes with an aqueous salt solution.

25 671. The method of Claim 670 wherein the aqueous salt solution comprises a salt selected from the group consisting of sodium chloride, magnesium chloride, potassium chloride, ammonium chloride, sodium acetate, ammonium acetate, a combination of two or more of these salts, one of these salts in a phosphate buffer, and a



combination of two or more of these salts in a phosphate buffer.

672. The method of Claim 671 wherein the salt solution is sodium chloride in a phosphate buffer.

5

673. The method of Claim 672 wherein the aqueous salt solution comprises between about 0 M to 0.5 M sodium chloride and between about 0.01 mM to 15 mM phosphate buffer at pH 7.

10

674. The method of Claim 671 wherein the aqueous salt solution comprises between about 0.005 to 0.1 M sodium chloride and about 10 mM phosphate buffer at pH 7.

15

675. The method of Claim 670, wherein the detection probes comprise nanoparticle-oligonucleotide conjugates.

676. The method of Claim 670, wherein the conjugates are gold nanoparticle-oligonucleotide conjugates.

20

677. The method of Claim 651 wherein the observing a detectable change comprises determining whether hybridization has occurred.

25

FIG. 1

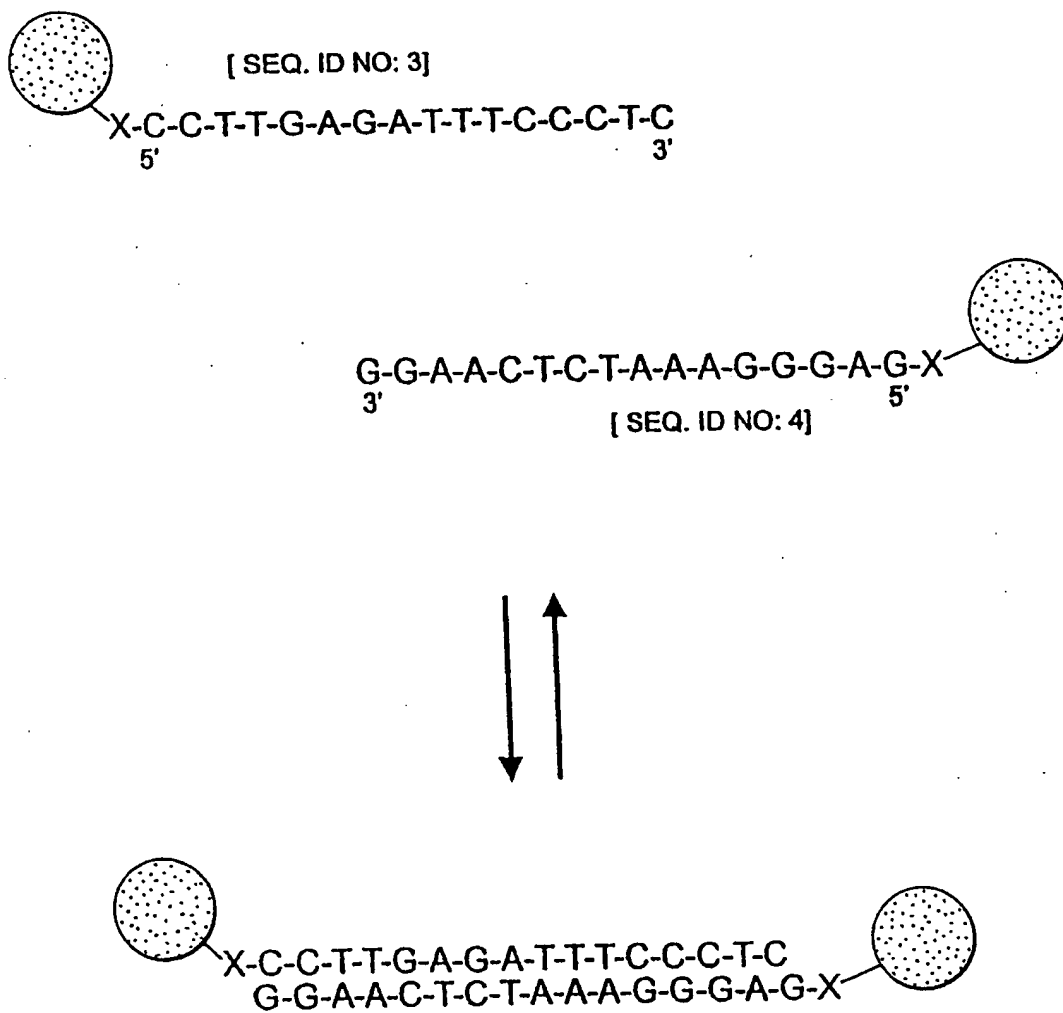

# FIG. 2

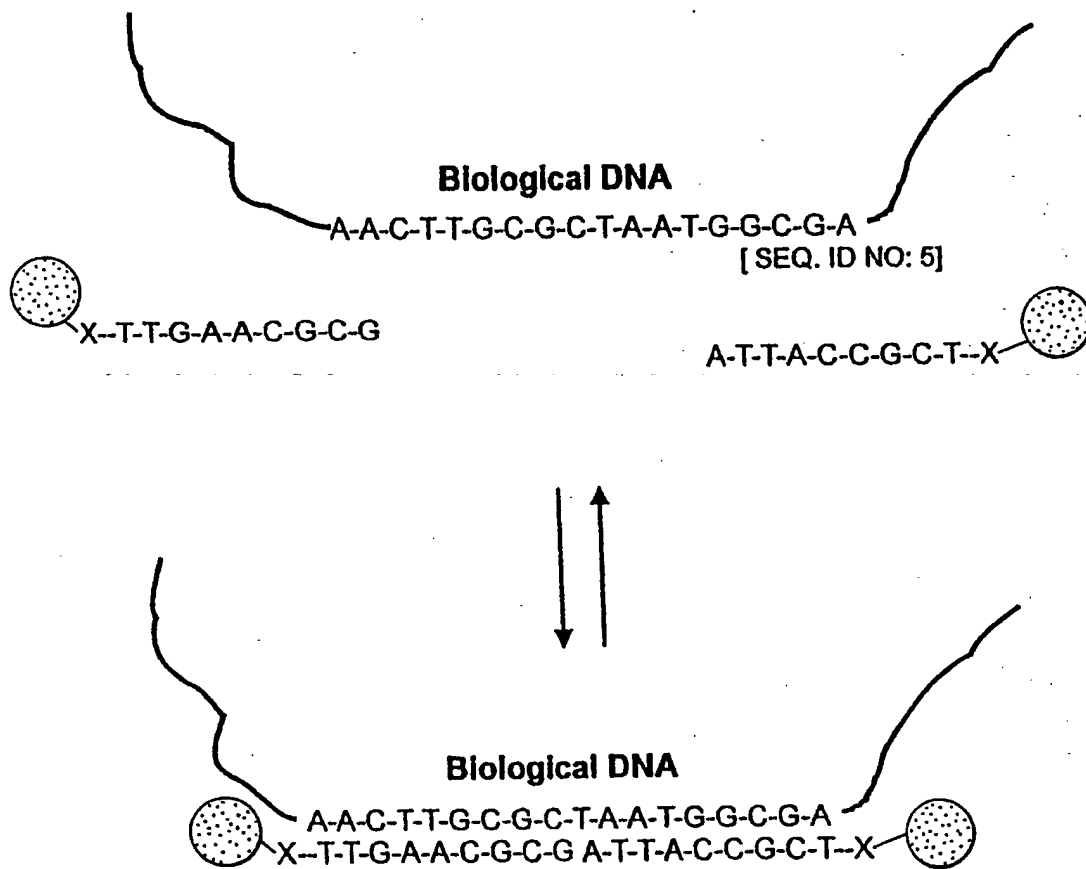
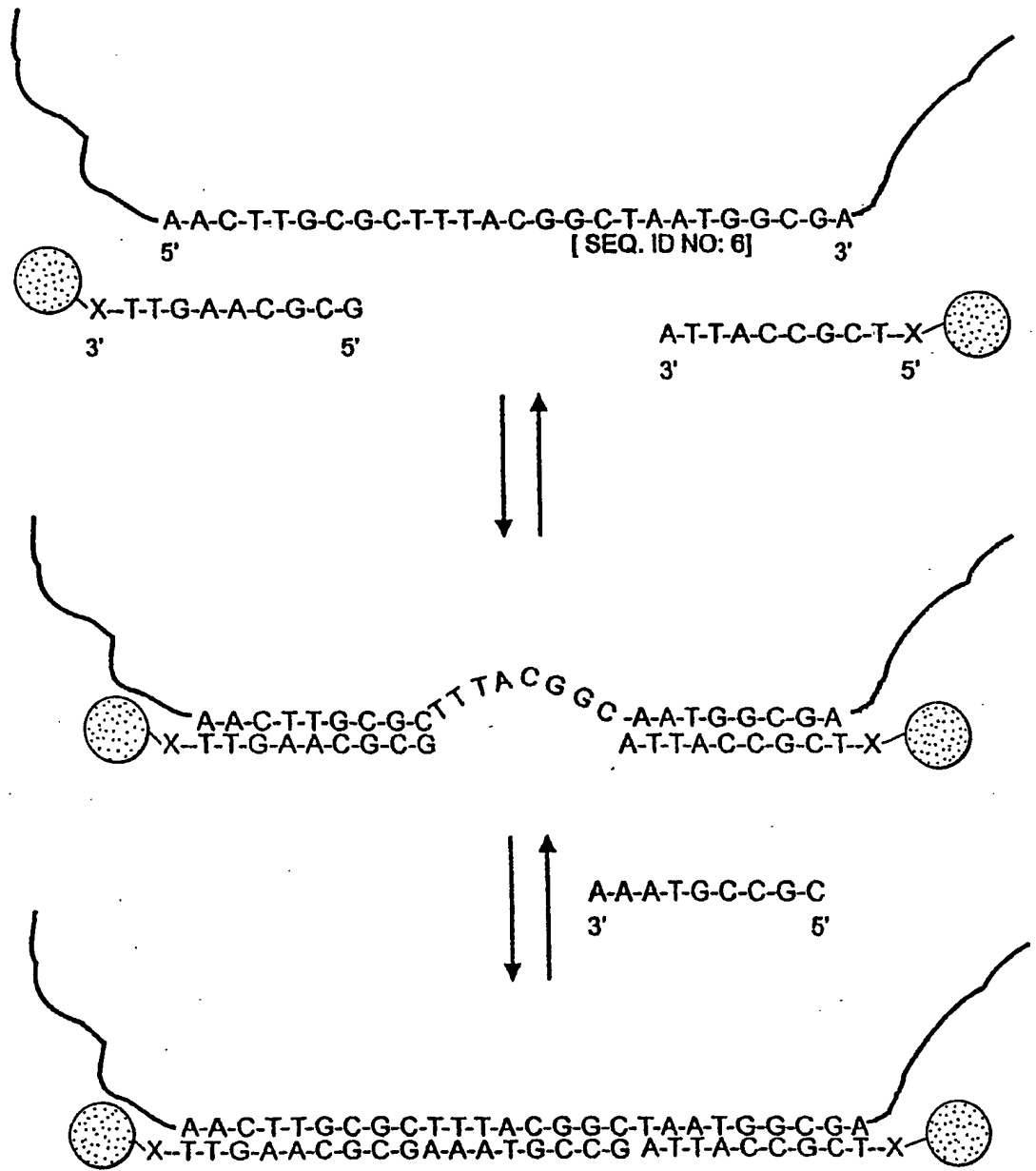
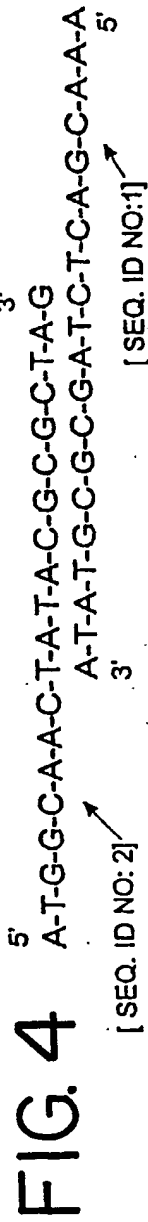

FIG. 3



Linking oligonucleotide



Heat

↕

Mix below T<sub>m</sub>

↕

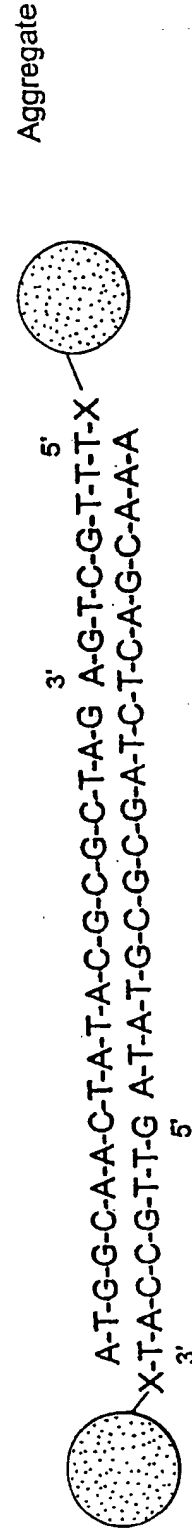

Heat

↕

Stand below T<sub>m</sub>

↕

Precipitate (formed by further cross-linking)

FIG. 5

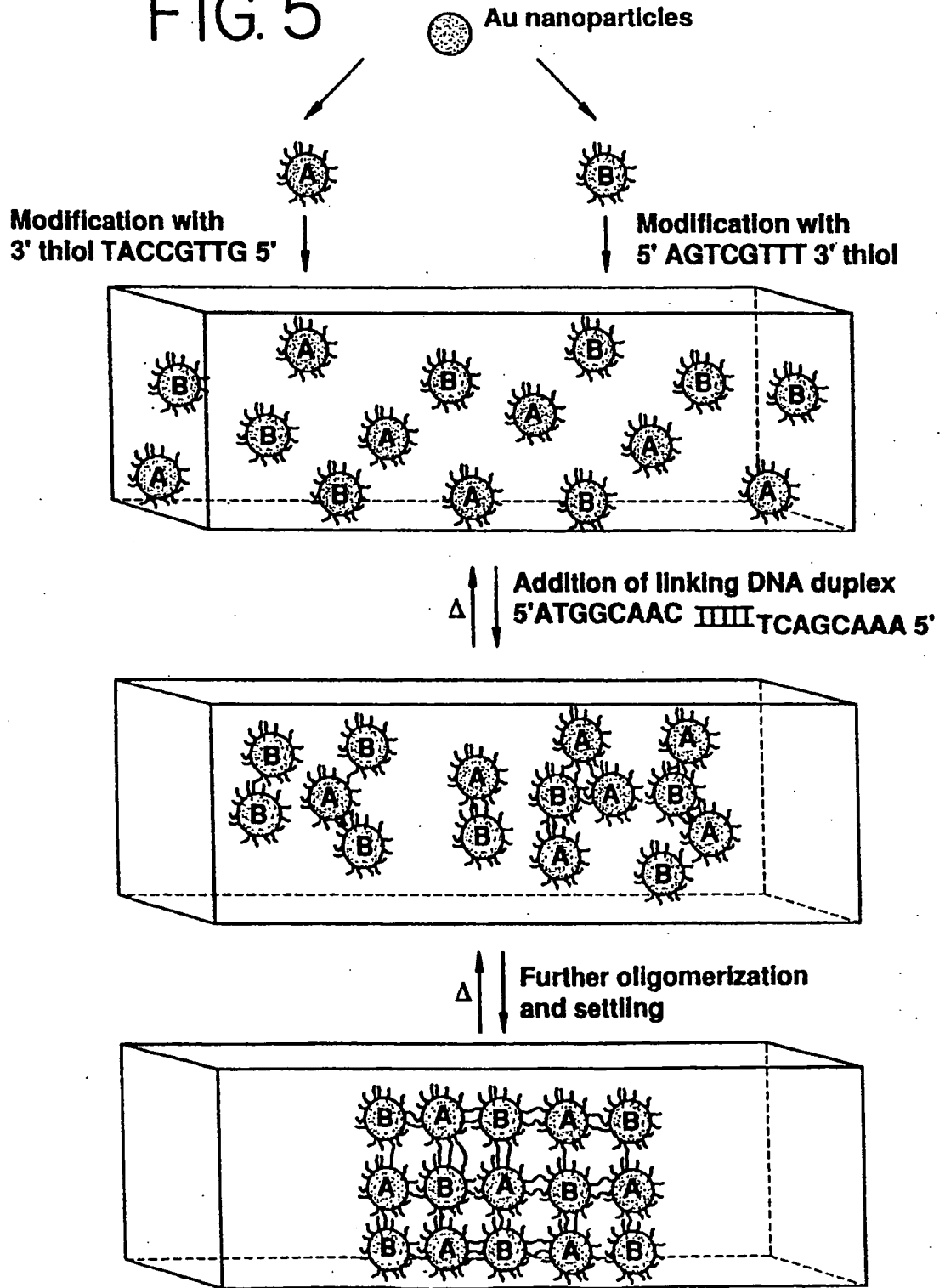

FIG.6A FIG.6B FIG.6C

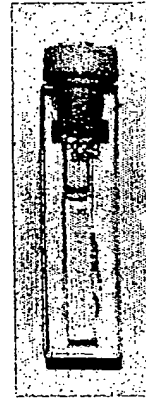
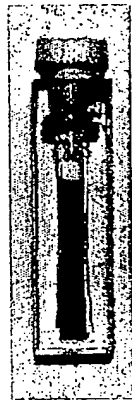

FIG. 8B

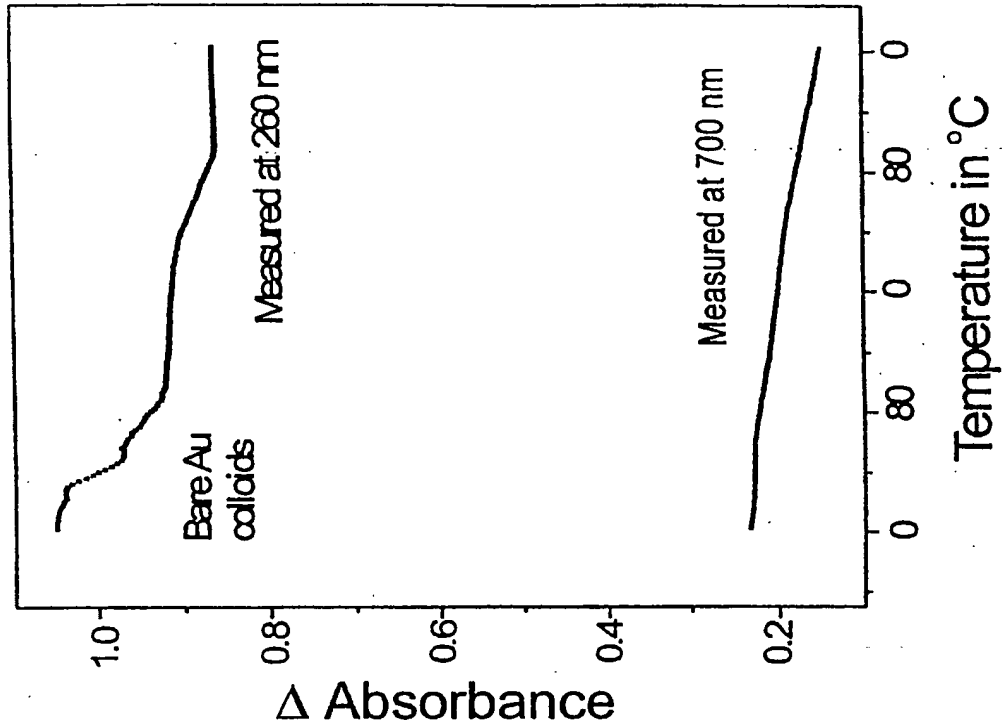

FIG. 8A

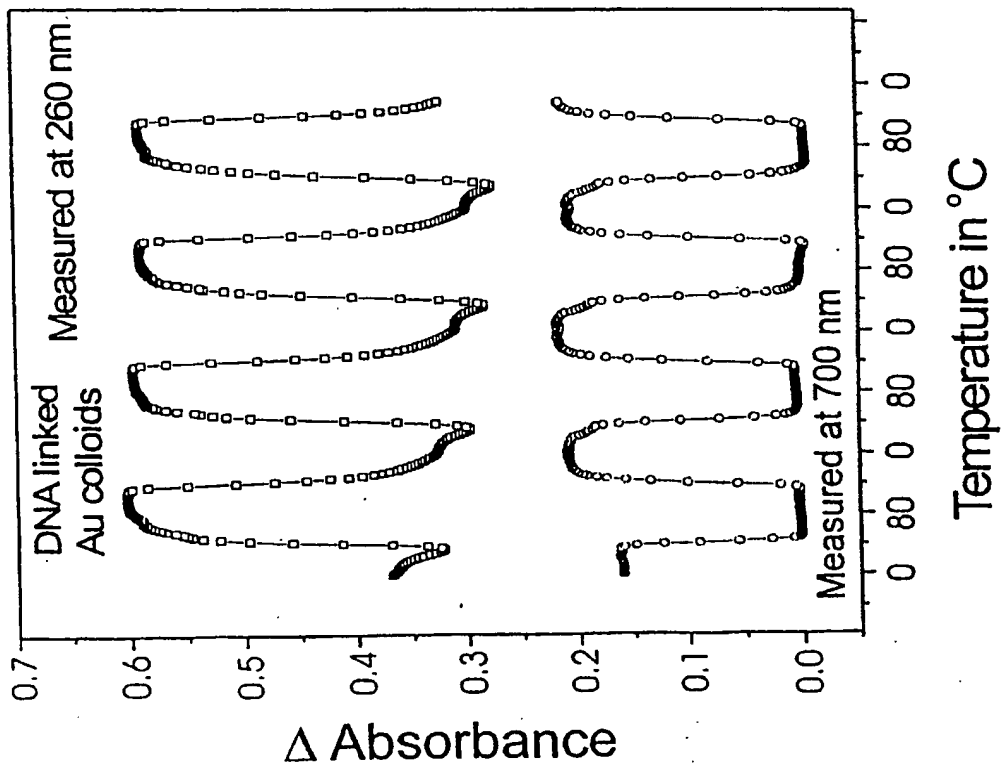



FIG. 9A

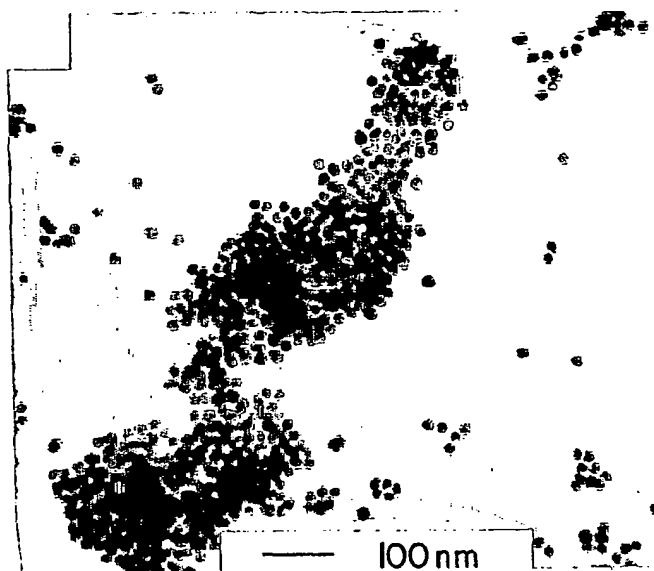

FIG. 9B

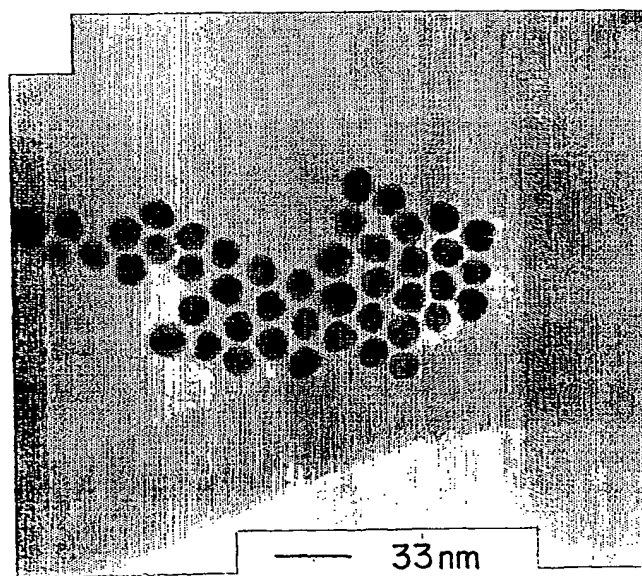

FIG. 7

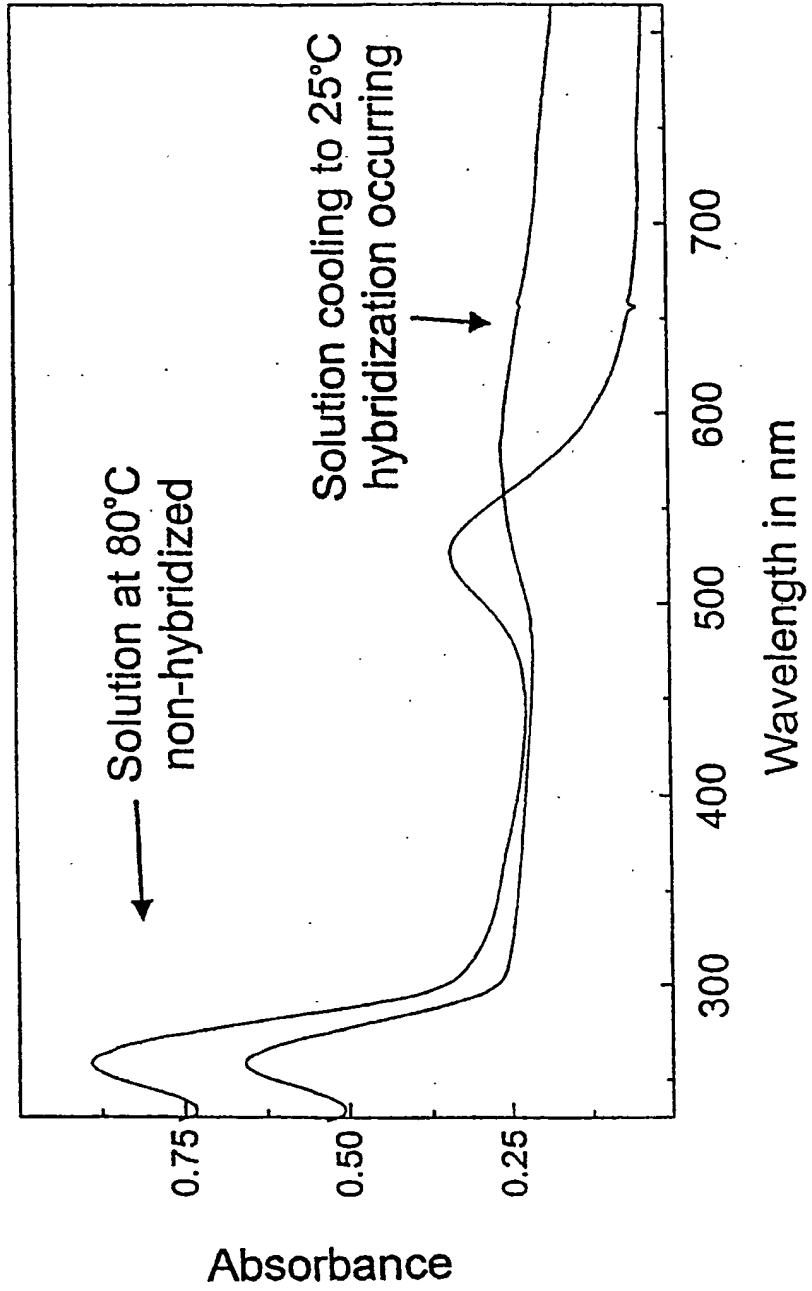

FIG. 10

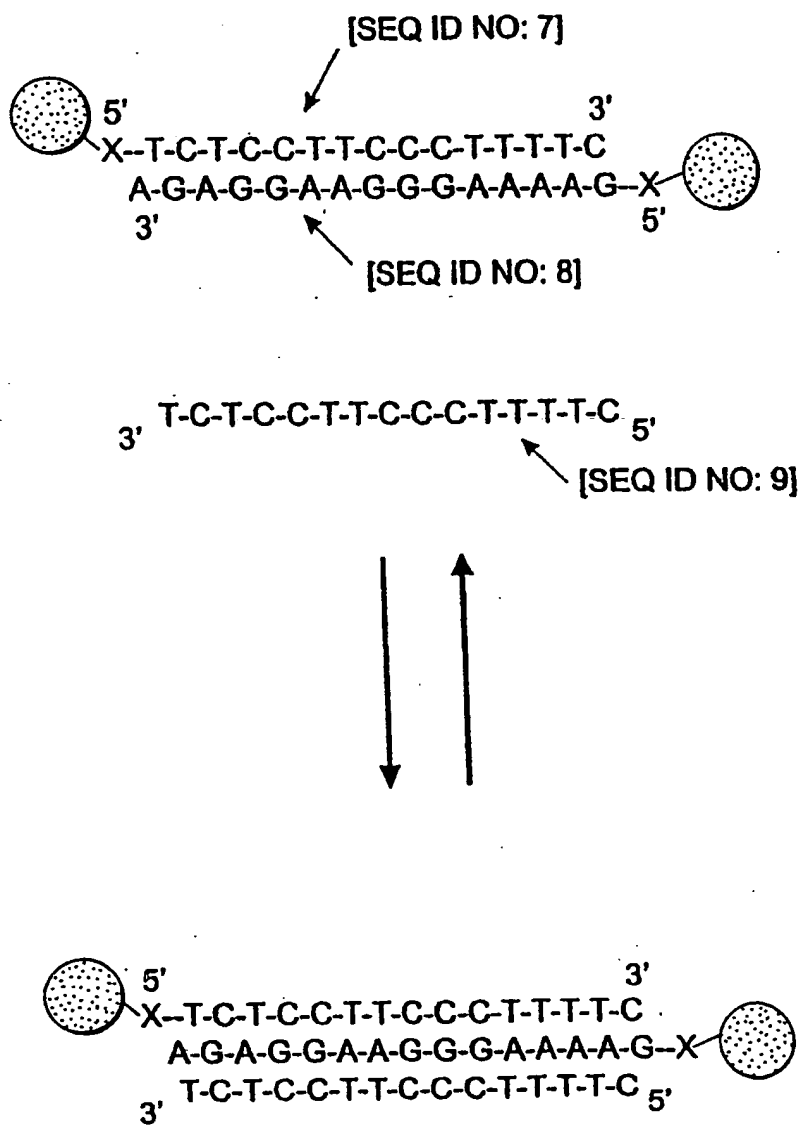
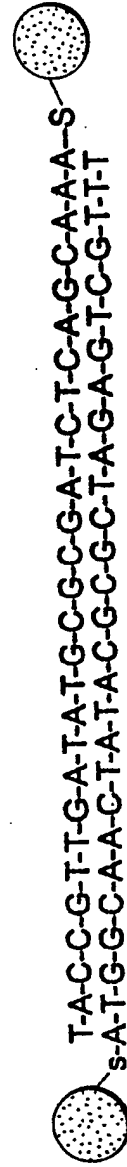
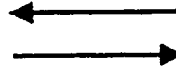
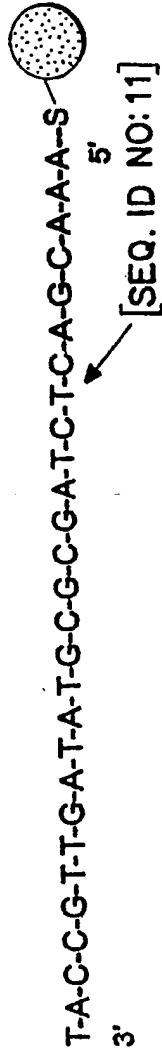
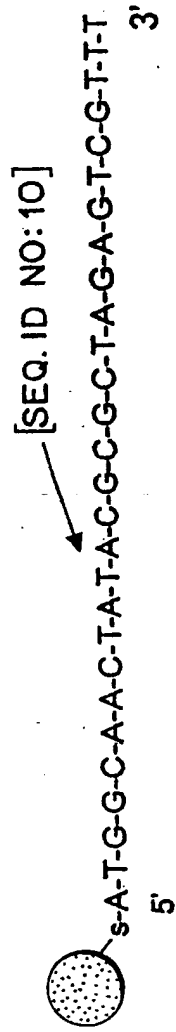
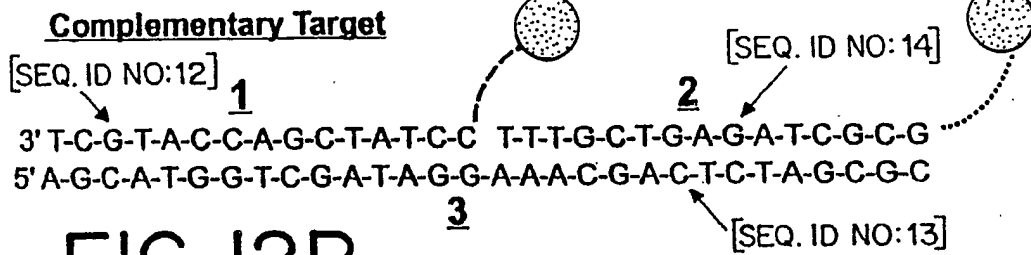

FIG. 11



# FIG. 12A



# FIG. 12B

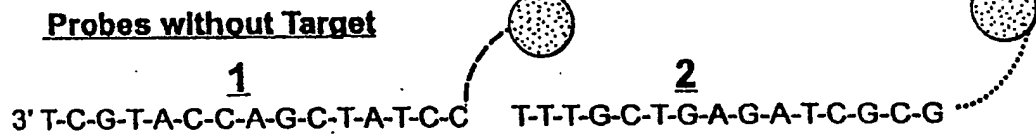

# FIG. 12C

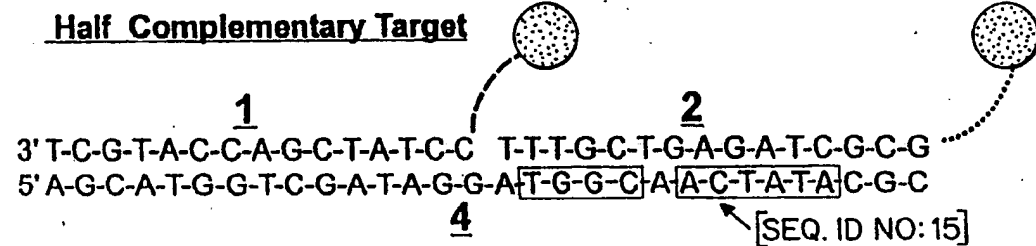

# FIG. 12D

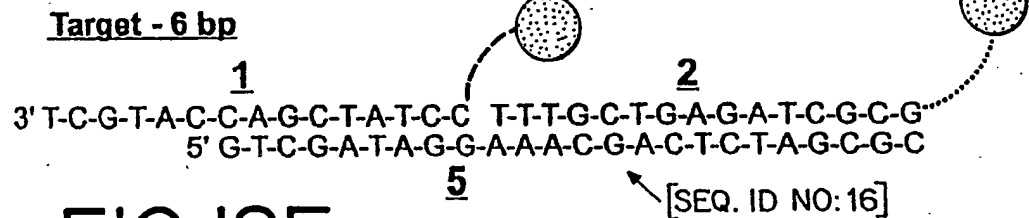

# FIG. 12E

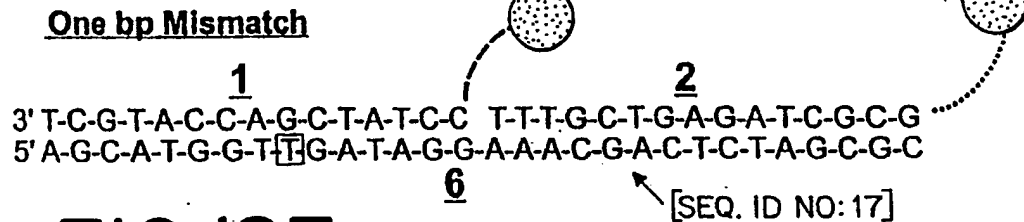

# FIG. 12F

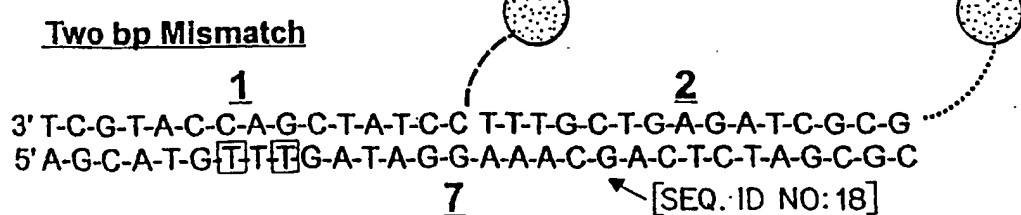
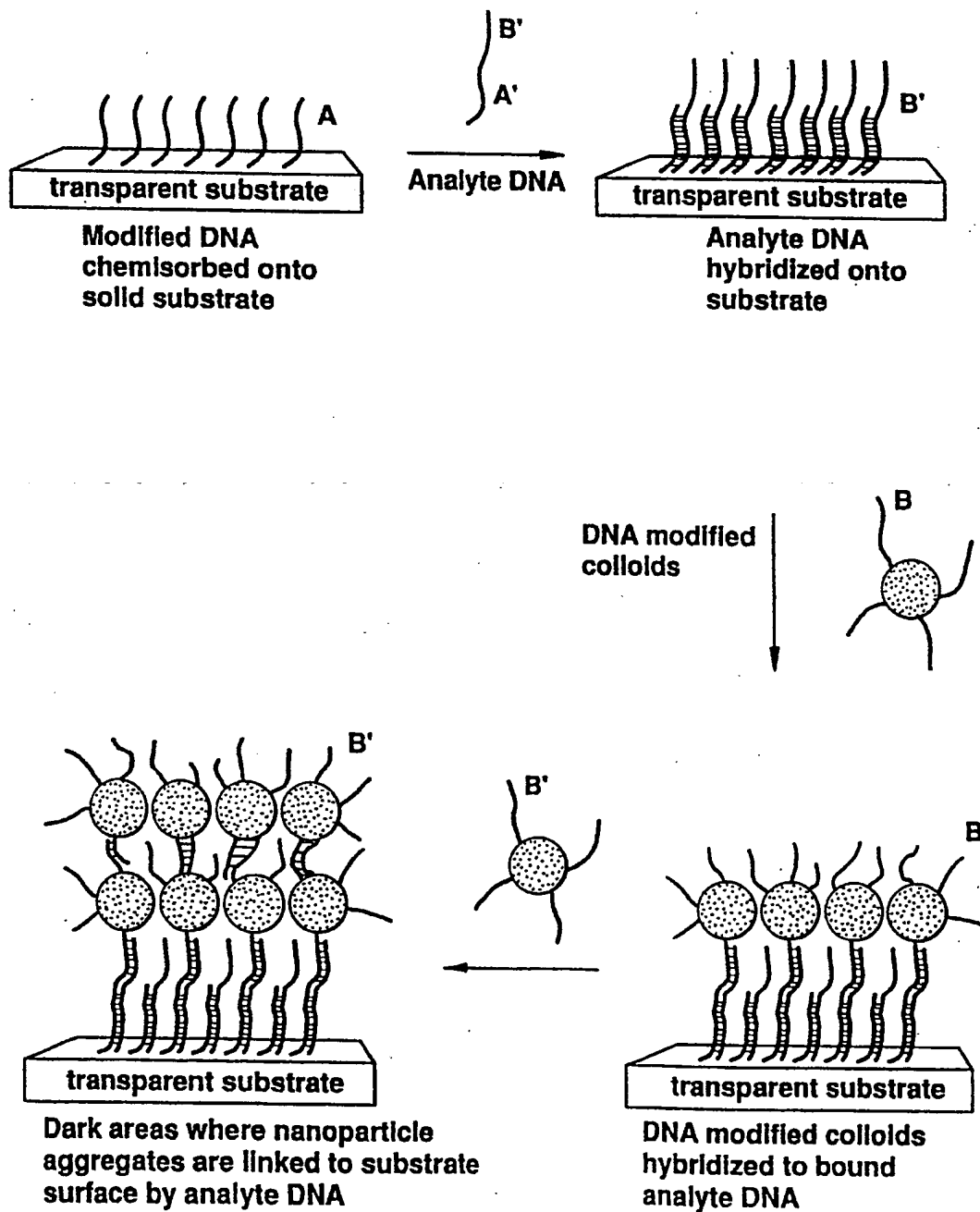
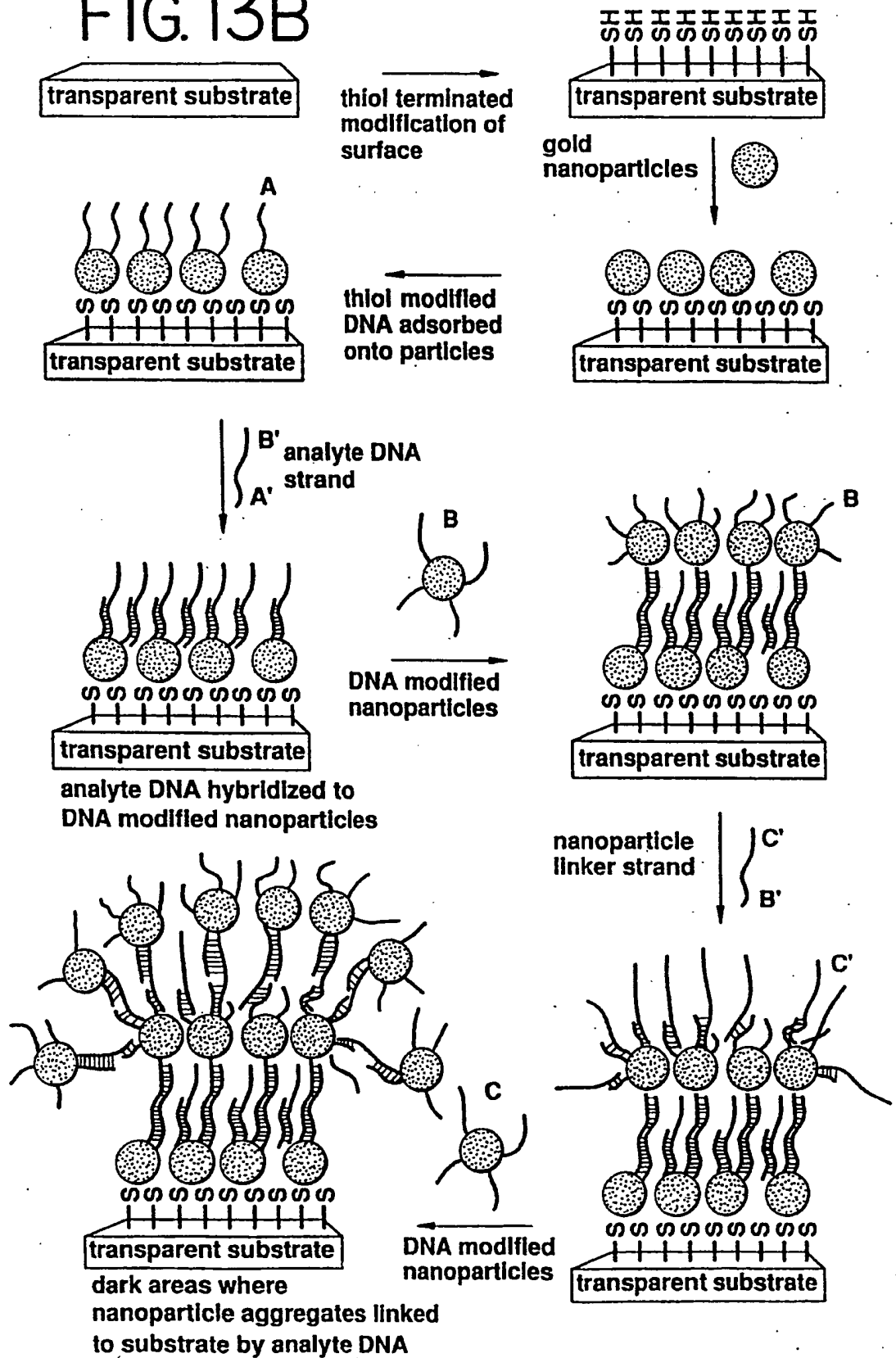

FIG. 13A



# FIG. 13B



# FIG. 14A

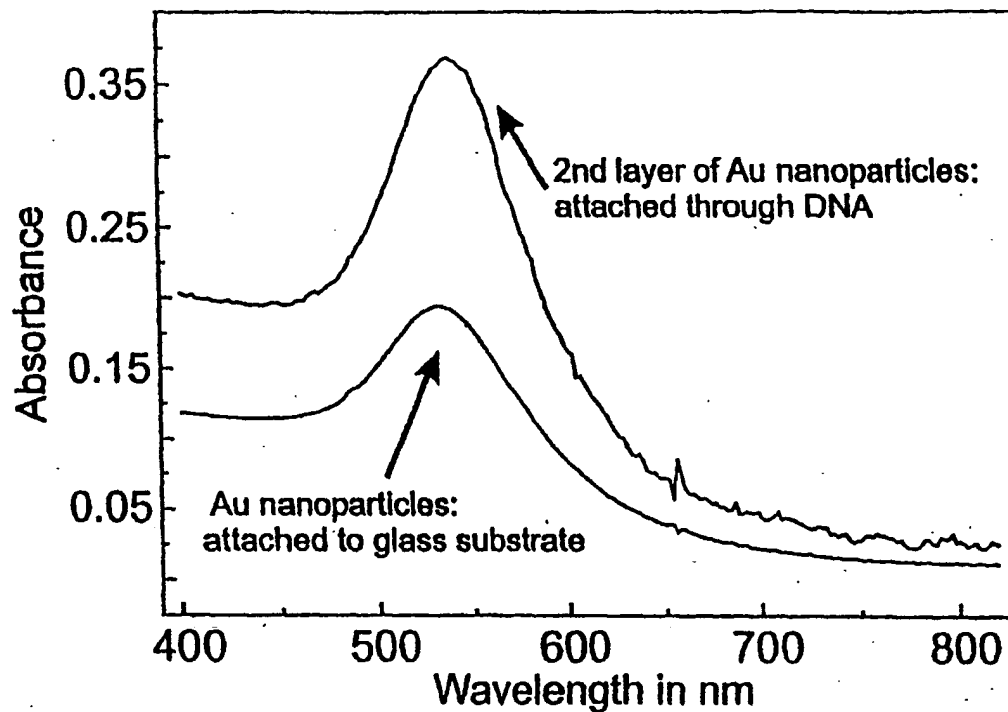

# FIG. 14B

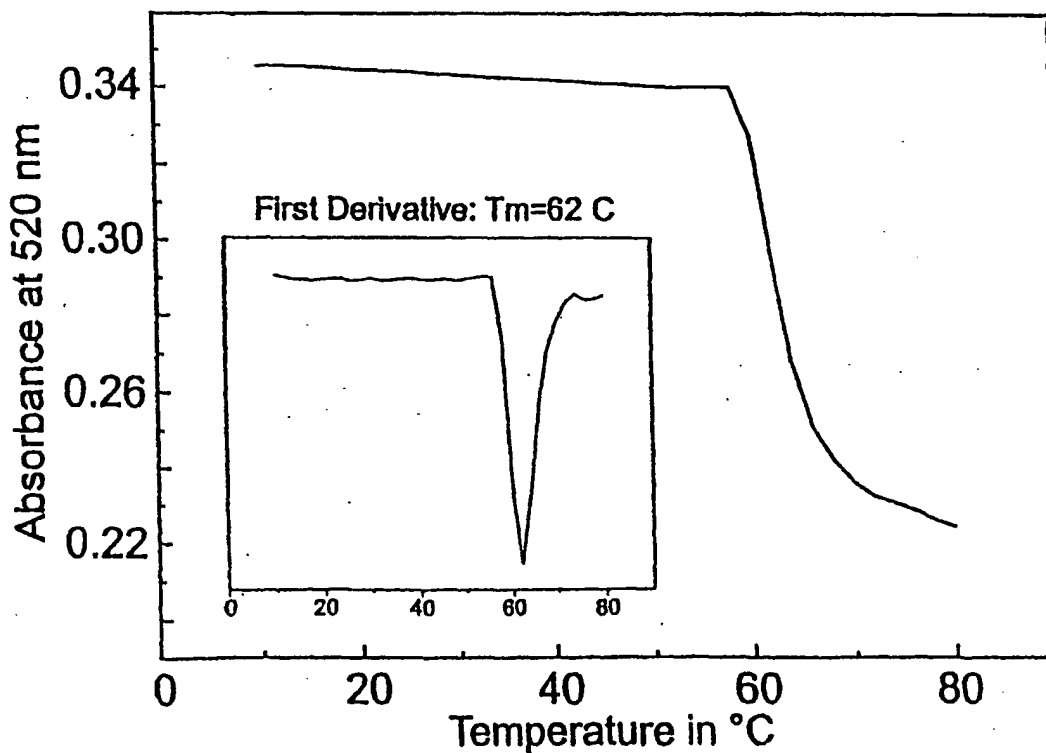



FIG. 15A

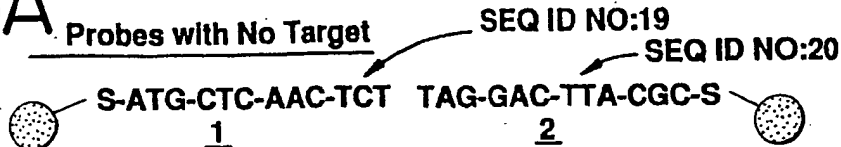

FIG. 15B

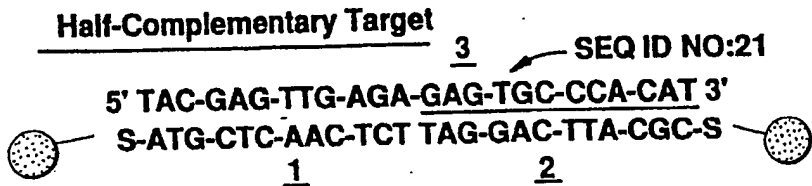

FIG. 15C

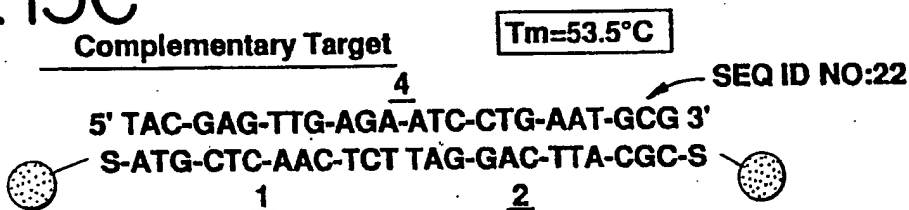

FIG. 15D

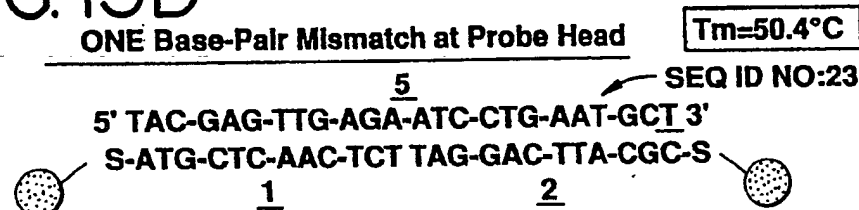

FIG. 15E

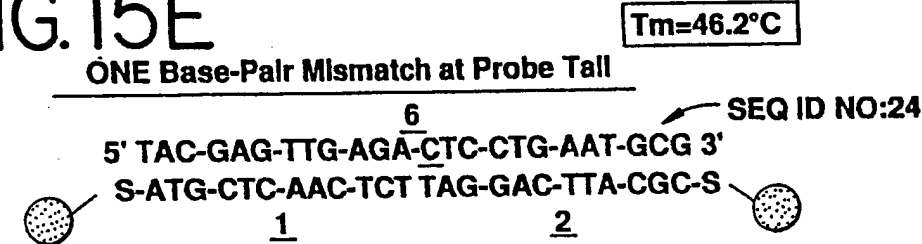

FIG. 15F

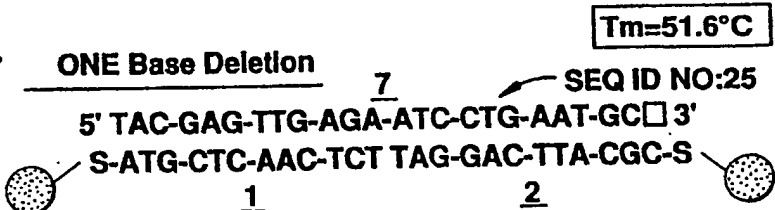

FIG. 15G

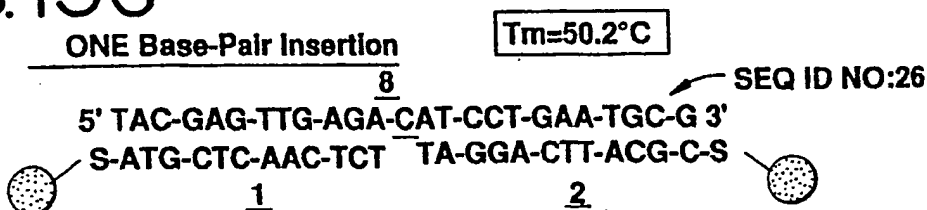

FIG. 16A

24 Base Template

5' TAC-GAG-TTG-AGA-ATC-CTG-AAT-GCG 3'  
-S-ATG-CTC-AAC-TCT TAG-GAC-TTA-CGC-S -  
1 2

FIG. 16B

48 Base Template with Complementary 24 Base Filler

5' TAC-GAG-TTG-AGA-CCG-TTA-AGA-CGA-GGC-AAT-CAT-GCA-ATC-CTG-AAT-GCG 3'  
-S-ATG-CTC-AAC-TCT GGC-AAT-TCT-GCT-CCG-TTA-GTA-CGT TAG-GAC-TTA-CGC-S -  
1 2

FIG. 16C

72 Base Template with Complementary 48 Base Filler

5' TAC-GAG-TTG-AGA-CCG-TTA-AGA-CGA-GGC-AAT-CAT-GCA-TAT-ATT-GGA-CGC-TTT-ACG-GAC-AAC-ATC-CTG-AAT-GCG 3'  
-S-ATG-CTC-AAC-TCT GGC-AAT-TCT-GCT-CCG-TTA-GTA-CGT-ATA-TAA-CCT-GCG-AAA-TGC-CTG-TTG TAG-GAC-TTA-CGC-S -  
1 2

FIG. 17B

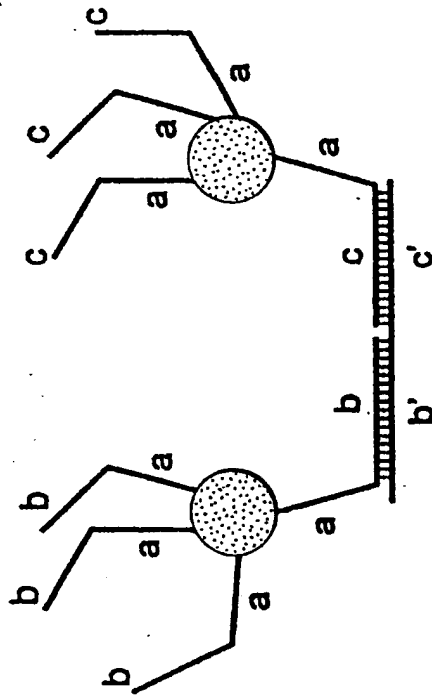

FIG. 17A

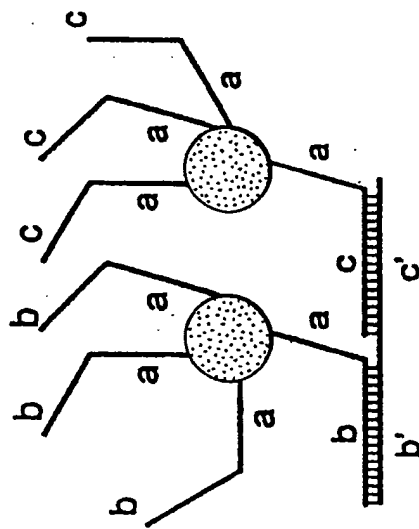

FIG. 17C

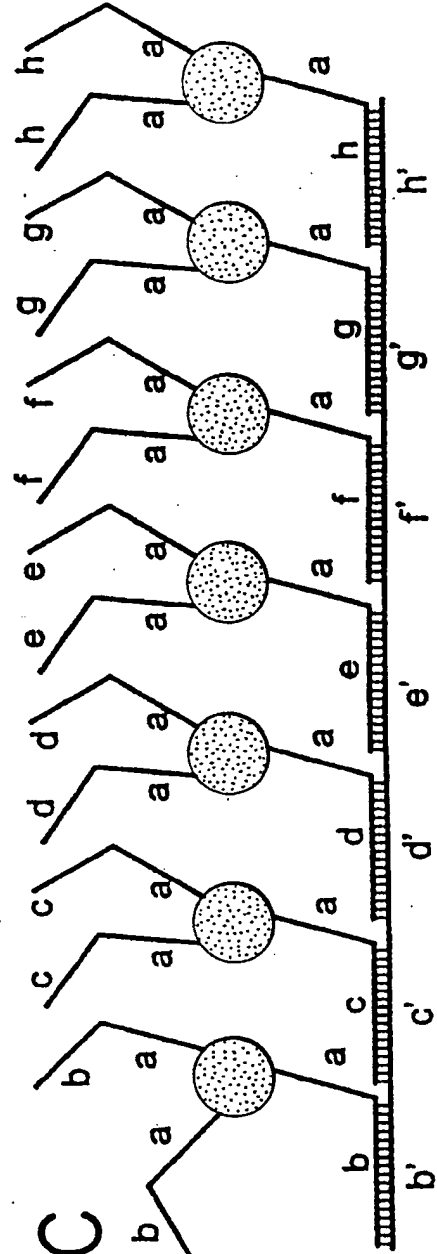

FIG. 17D

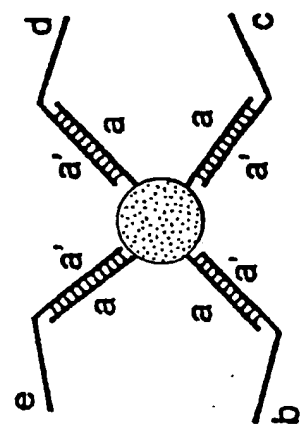
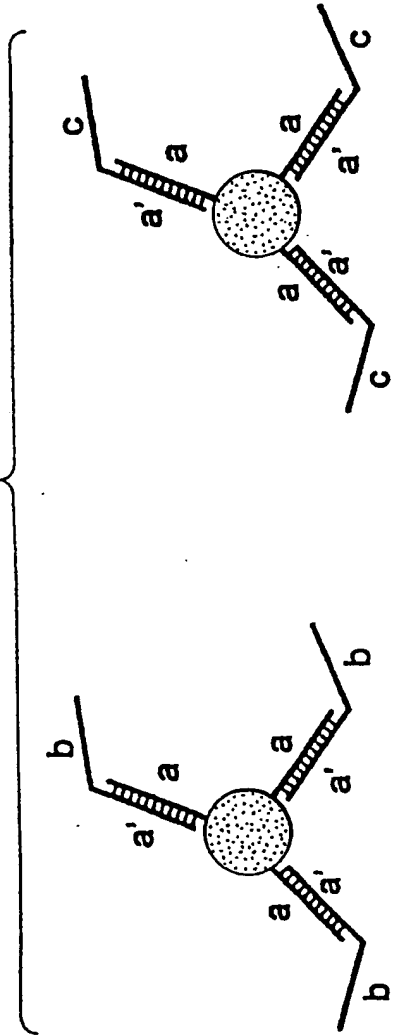
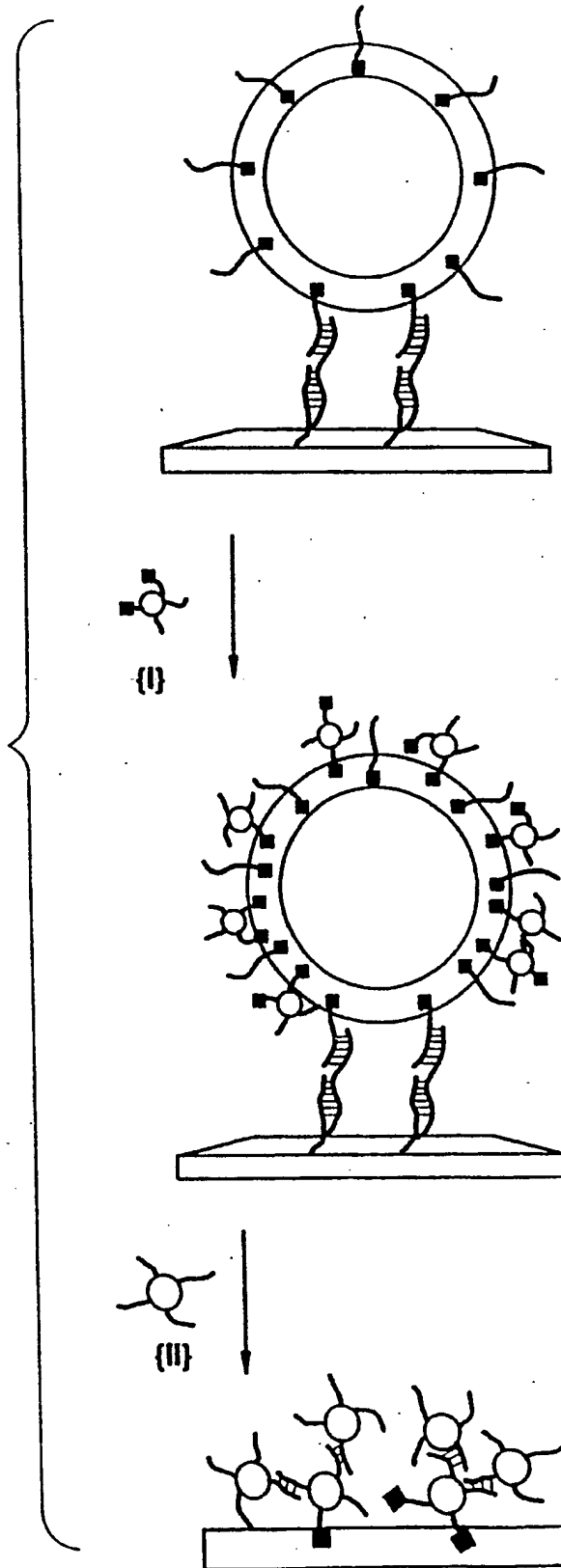
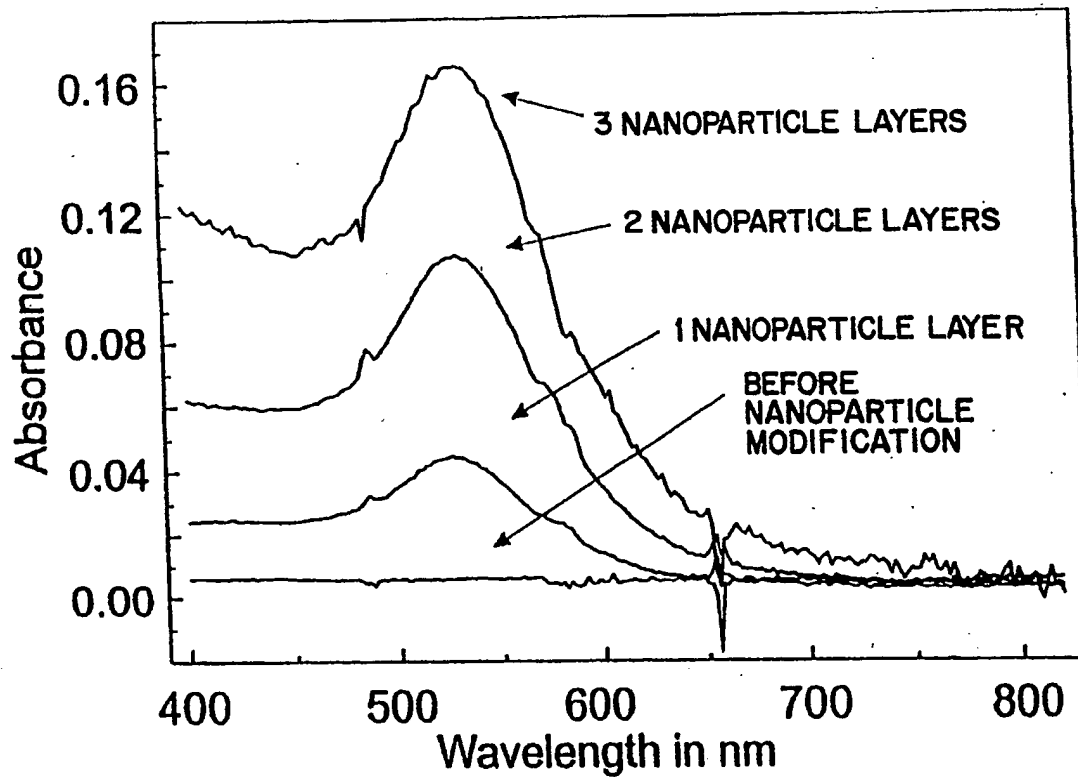

FIG. 17E

FIG. 18



# FIG. 19A



# FIG. 19B

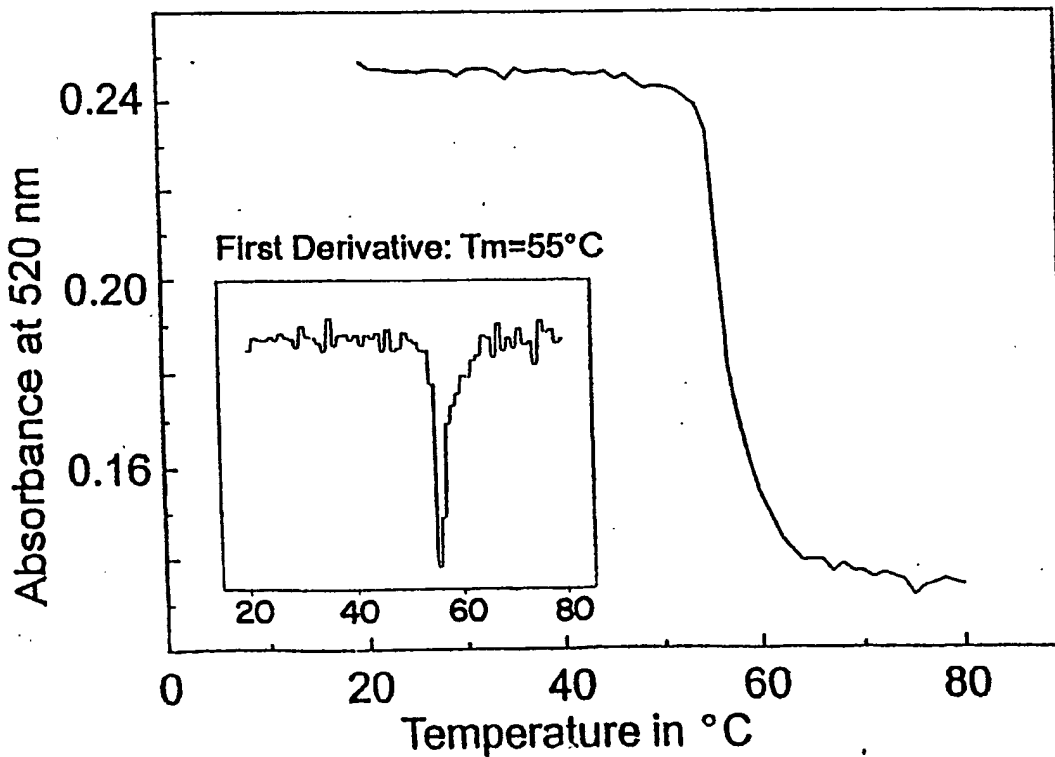

FIG. 20A

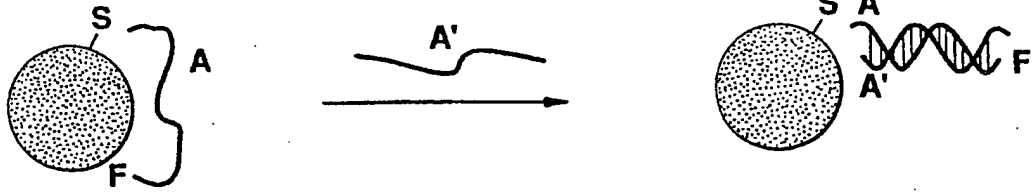
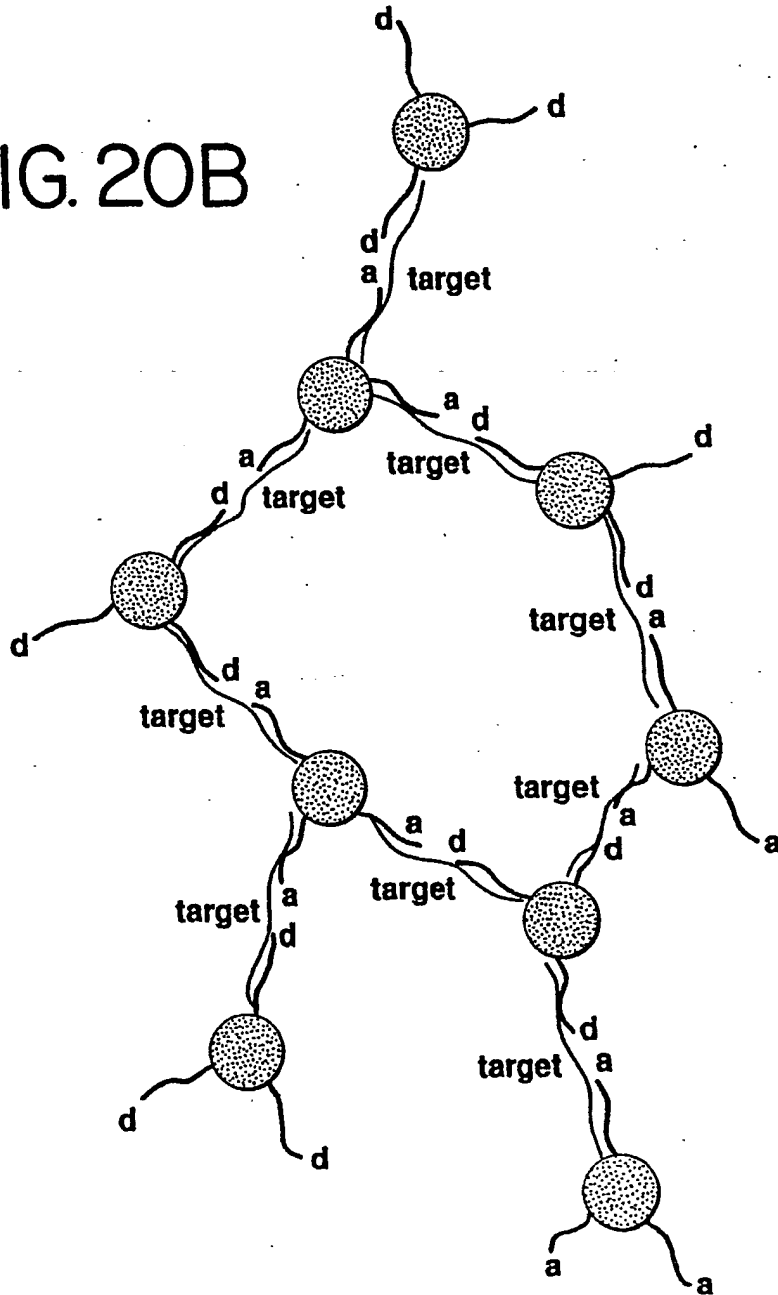

FIG. 20B



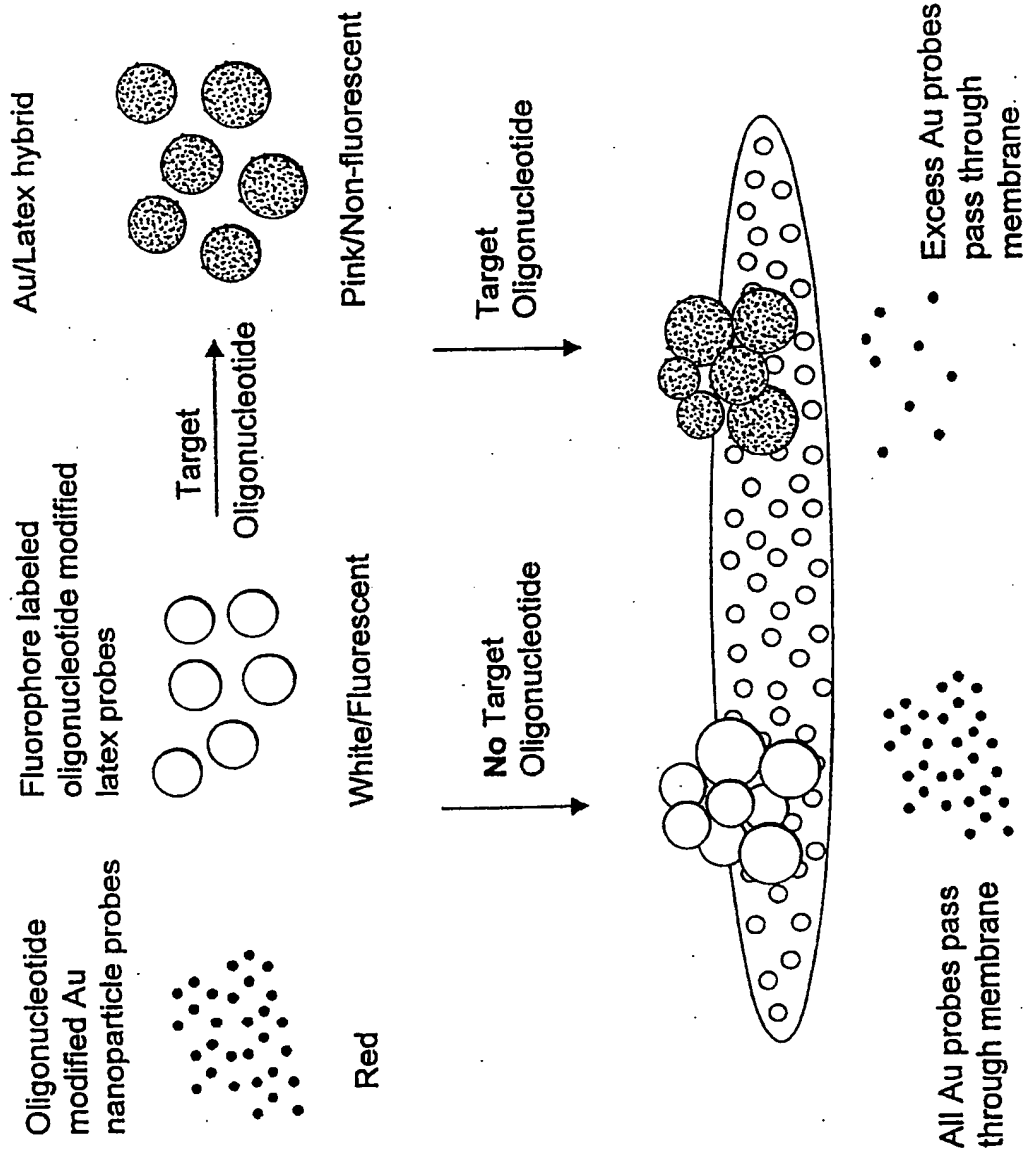
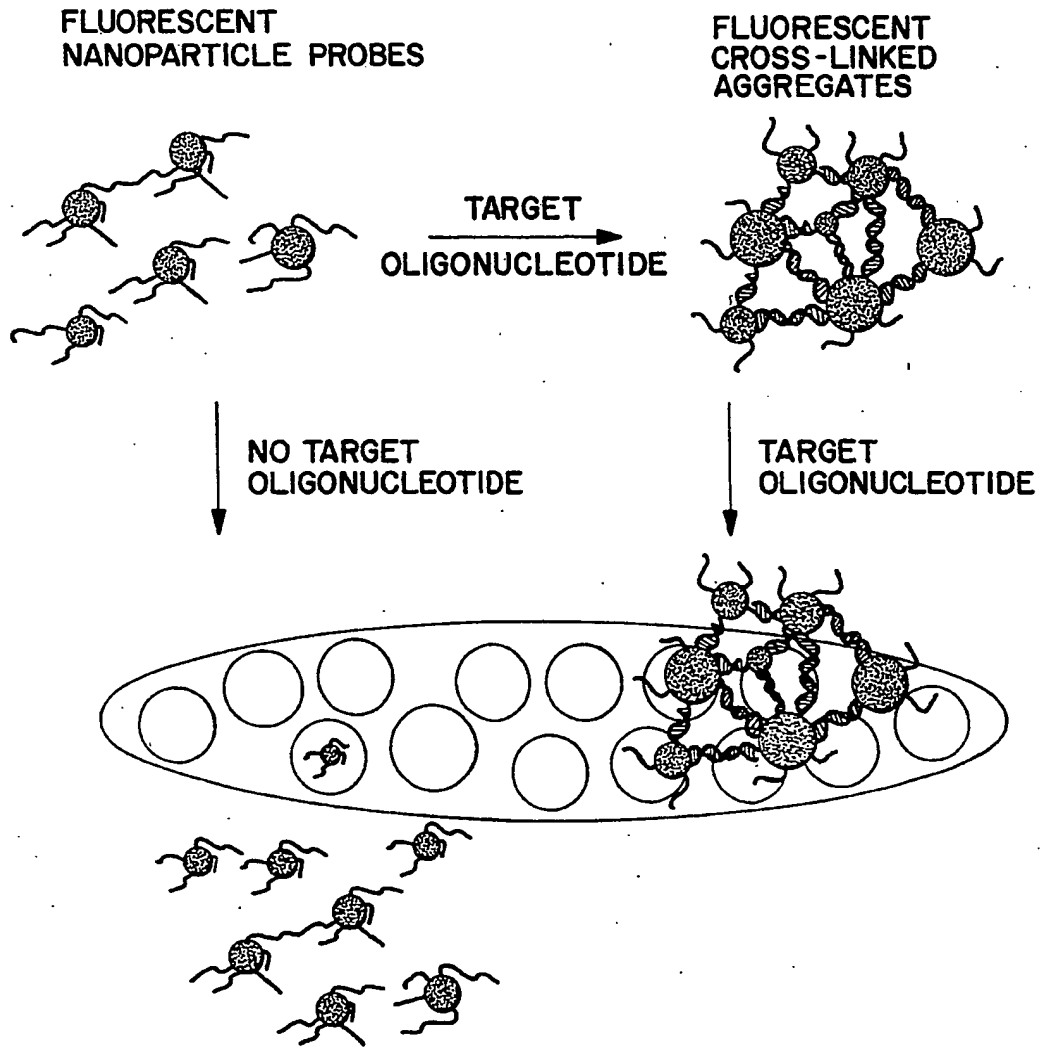

FIG. 21



# FIG. 22



**THE FLUORESCENT NANOPARTICLE PROBES PASS THROUGH THE MEMBRANE**

**THE FLUORESCENT CROSS-LINKED AGGREGATES ARE RETAINED BY THE MEMBRANE**

# FIG. 23

## Anthrax PCR Product

5'G GCG GAT GAG TCA GTA GTT AAG GAG GCT CAT AGA GAA GTA ATT AAT  
 3'C CGC CTA CTC AGT CAT CAA TTC CTC CGA GTA TCT CTT CAT TAA TTA

TCG TCA ACA GAG GGA TTA TTG TTA AAT ATT GAT AAG GAT ATA AGA AAA  
 AGC AGT TGT CTC CCT AAT AAC AAT TTA TAA CTA TTC CTA TAT TCT TTT

ATA TTA TCC AGG GTT ATA TTG TAG AAA TTG AAG ATA CTG AAG GGC TT 3'  
 TAT AAT AGG TCC CAA TAT AAC ATC TTT AAC TTC TAT GAC TTC CCG AA 5'

**141 mer Anthrax PCR product** [SEQ ID NO:36]

3' CTC CCT AAT AAC AAT 

[SEQ ID NO:37]

3' TTA TAA CTA TTC CTA 

[SEQ ID NO:38]

Oligonucleotide-Nanoparticle Probes

### Blocker Oligonucleotides

3' C CGC CTA CTC AGT CAT CAA TTC CTC CGA GT  
 3' A TCT CTT CAT TAA TTA AGC AGT TGT  
 3' TAT TCT TTT TAT AAT AGG TCC CAA TAT  
 3' AAC ATC TTT AAC TTC TAT GAC TTC CCG AA

[SEQ ID NO:39]

[SEQ ID NO:40]

[SEQ ID NO:41]

[SEQ ID NO:42]

# FIG. 24

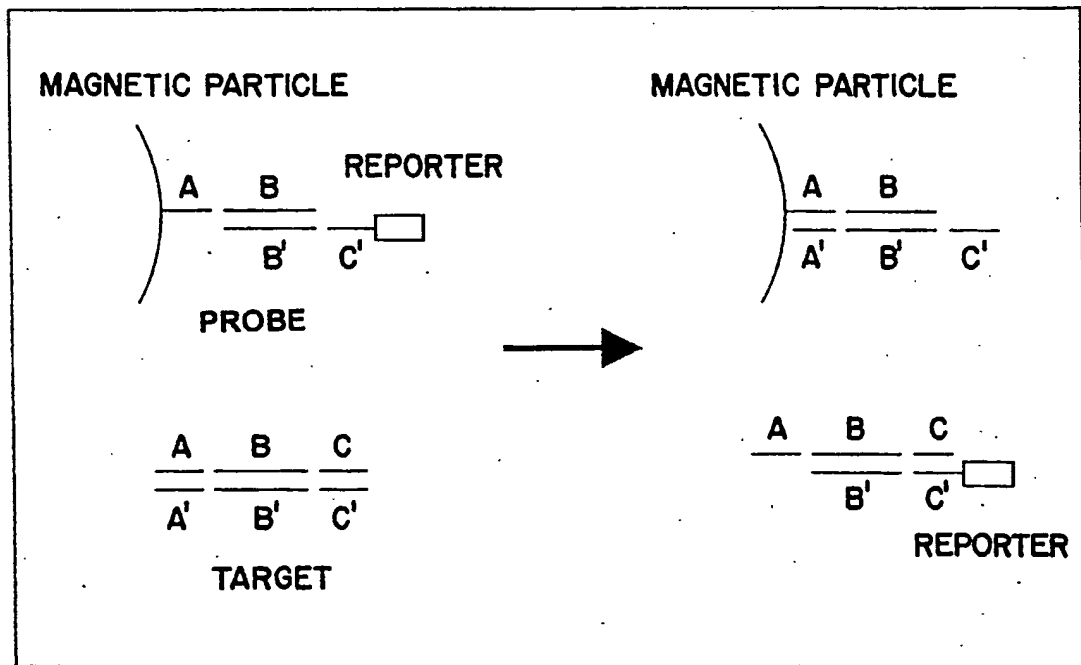
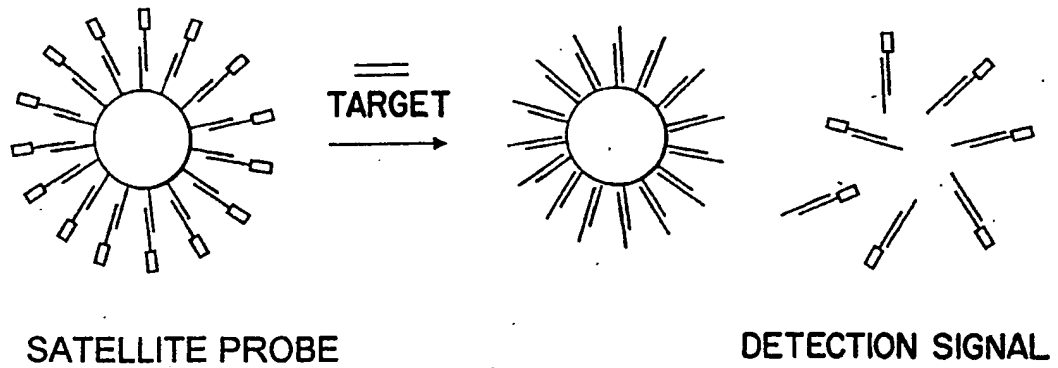



FIG. 26A

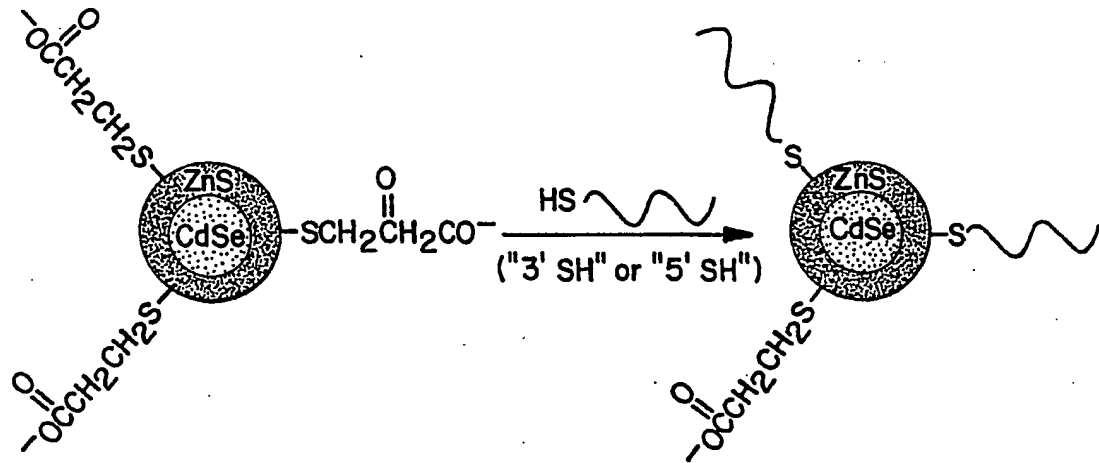
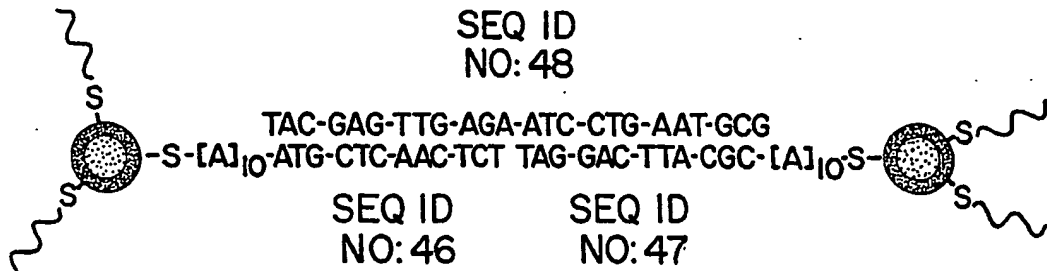
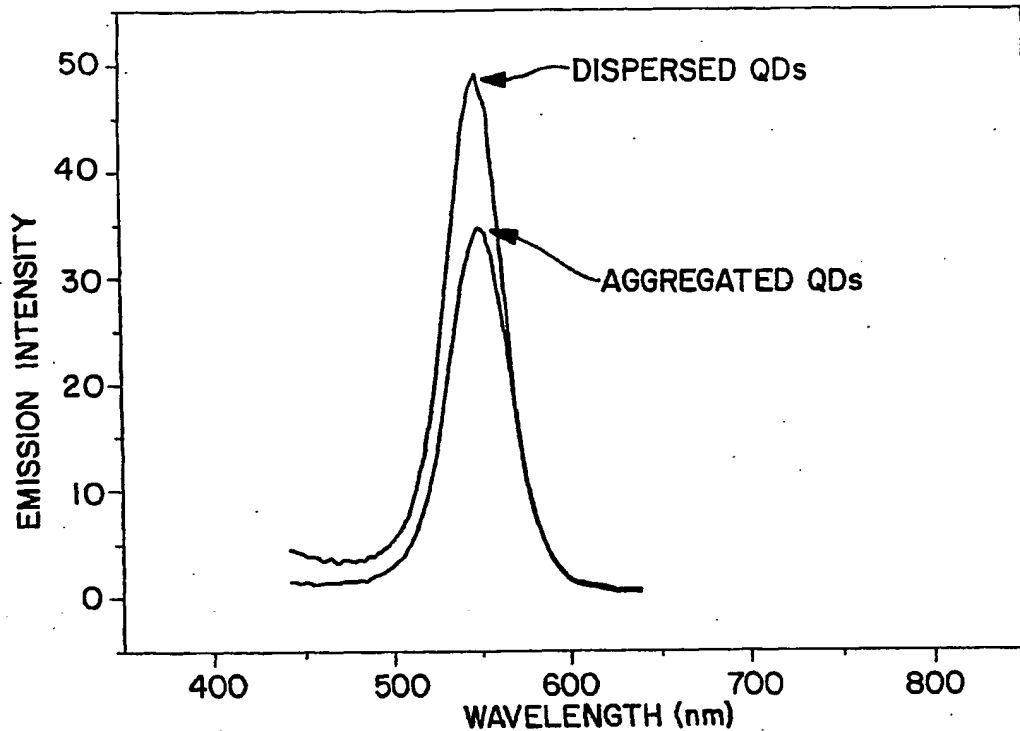

FIG. 26B



# FIG. 27A



# FIG. 27B

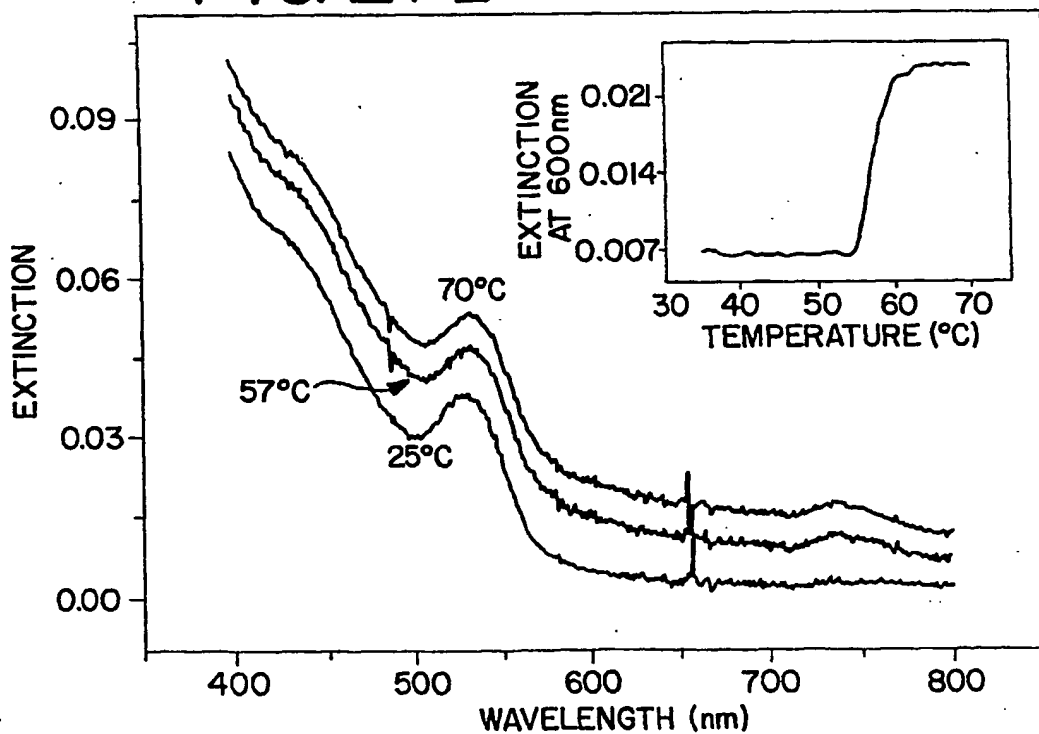

# FIG. 27C

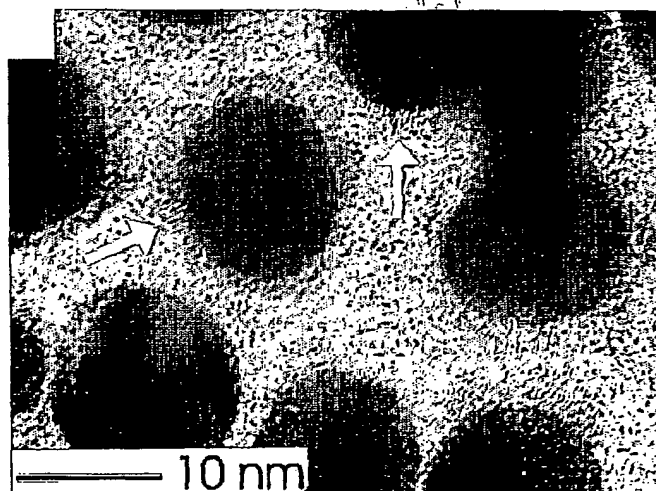

# FIG. 27D

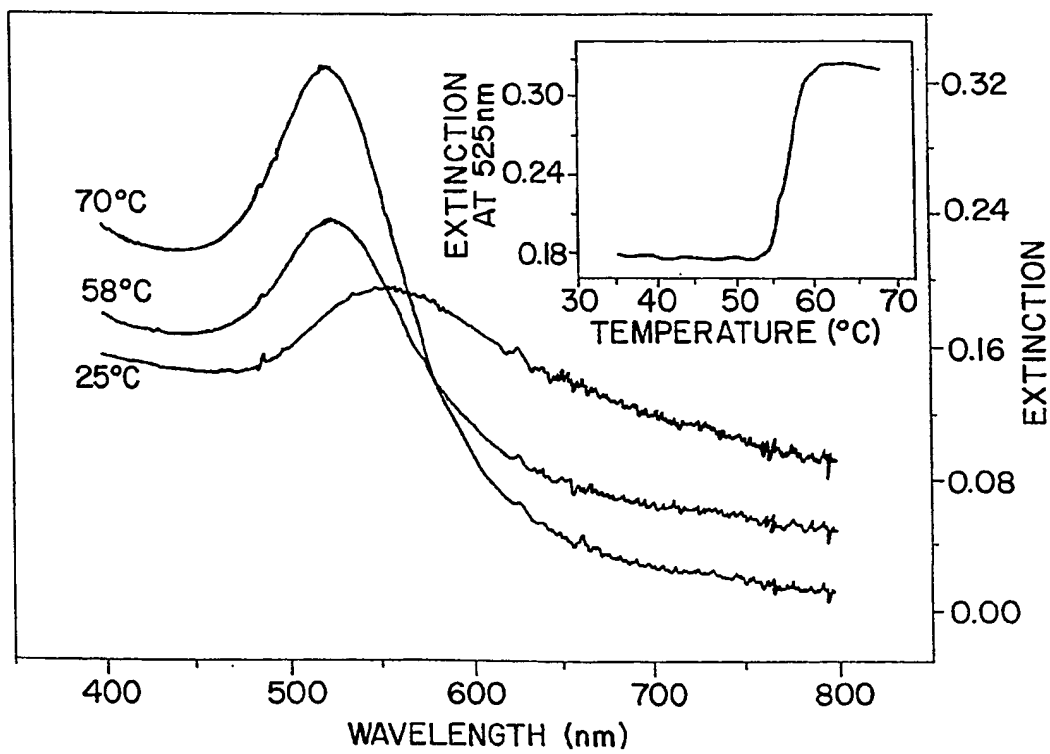

FIG. 28A

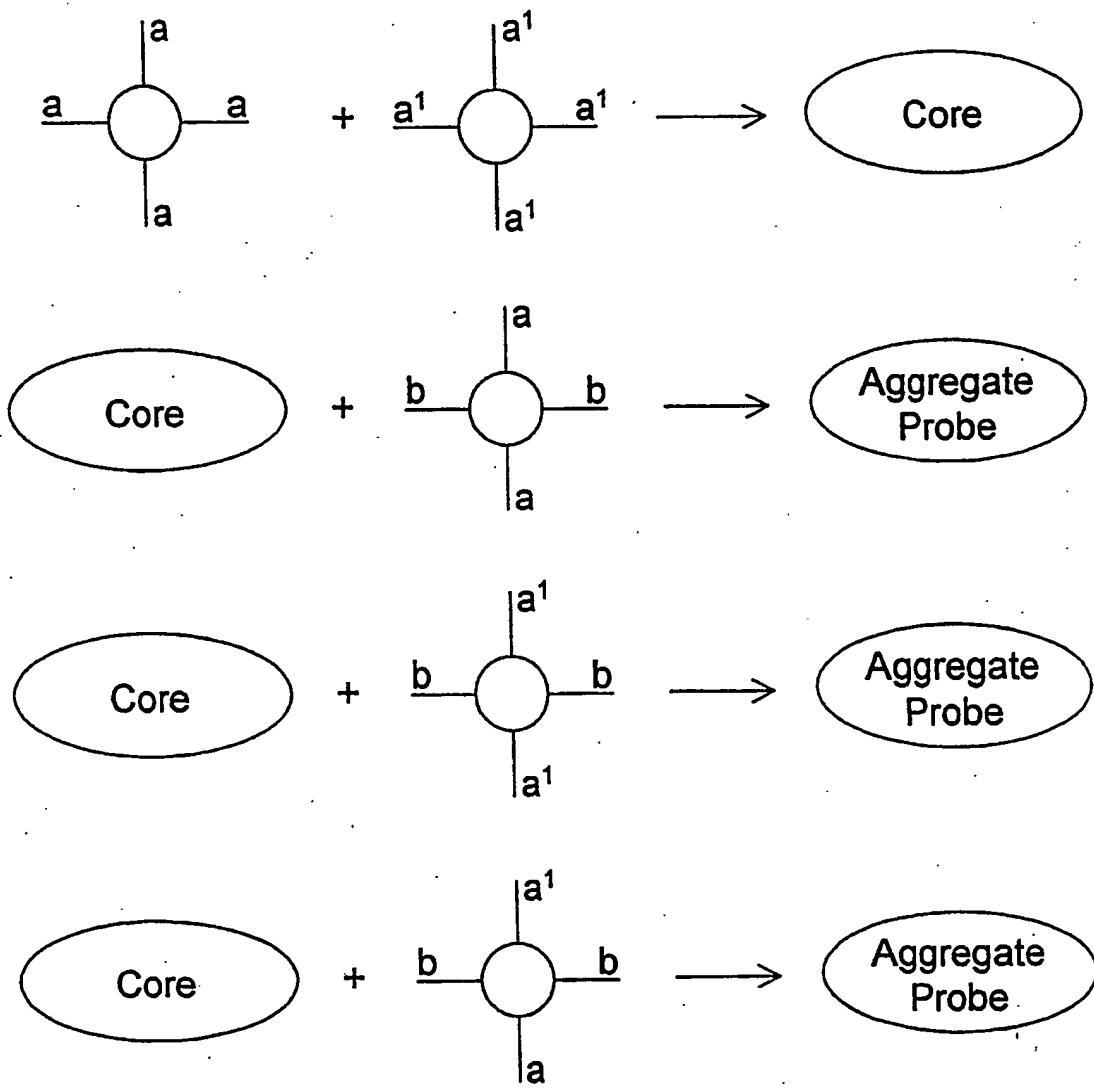



FIG. 28B

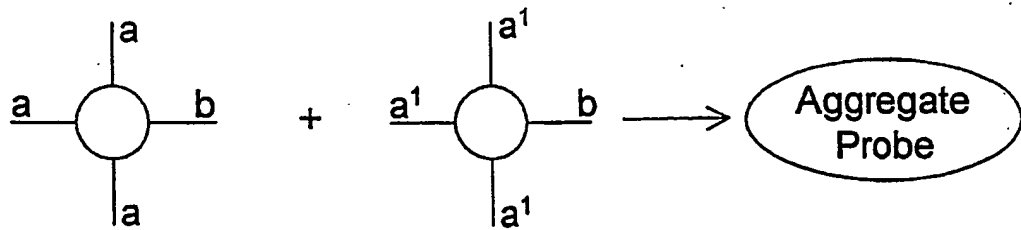

FIG. 28C

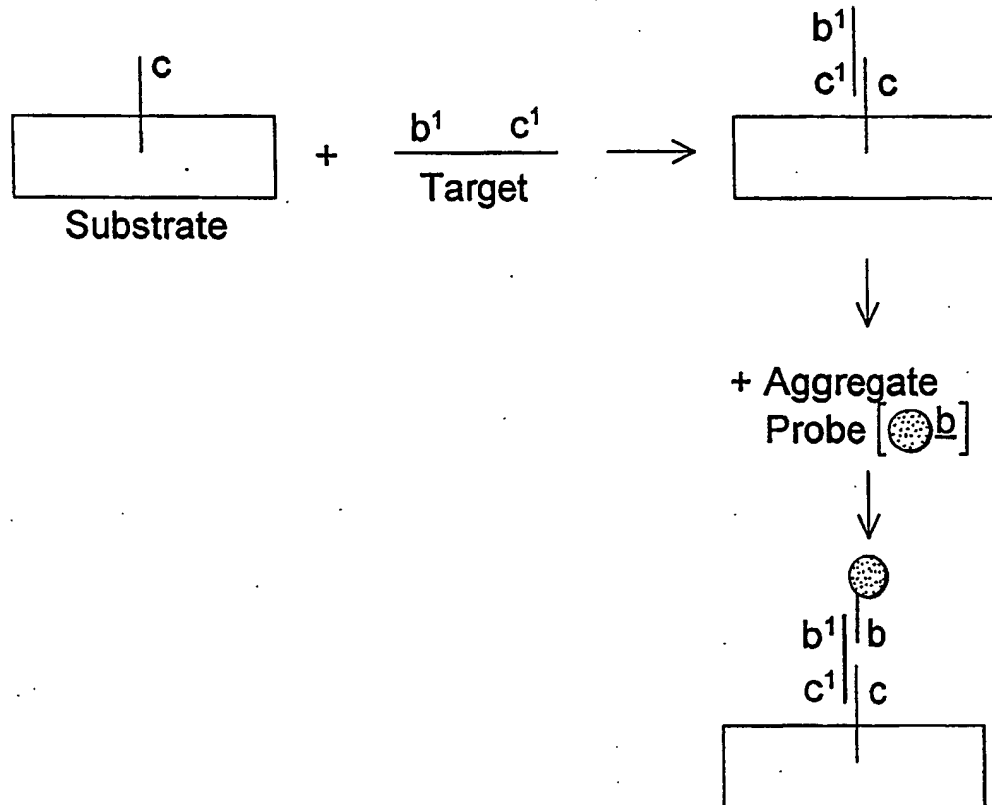
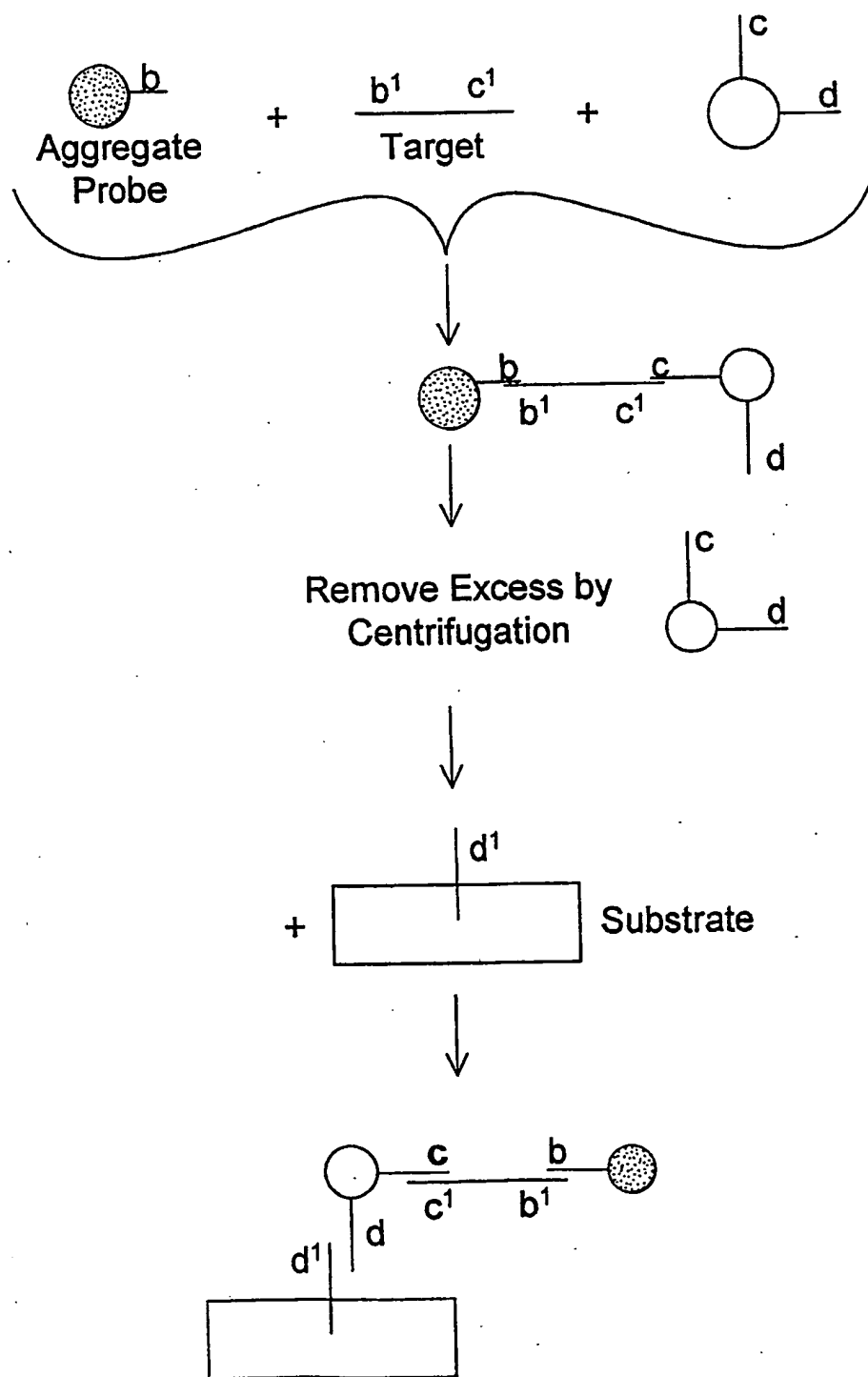
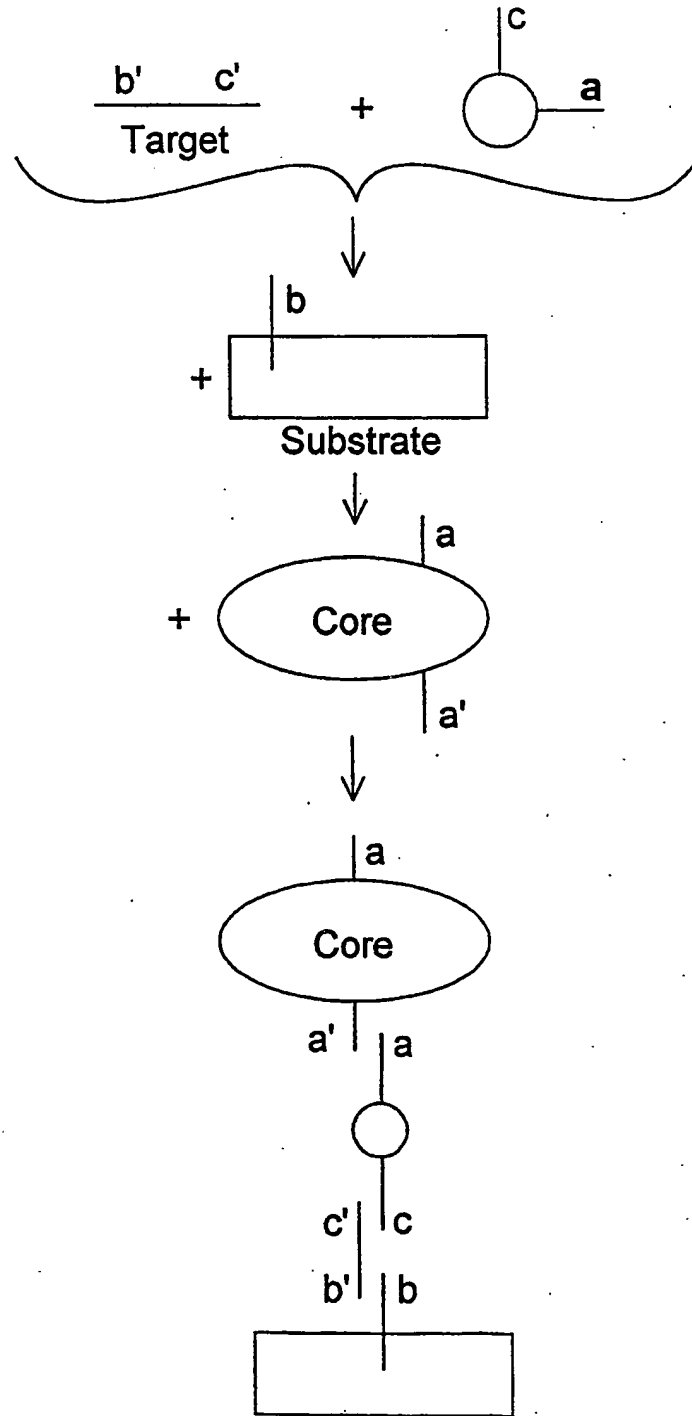

FIG. 28D



# FIG. 28E



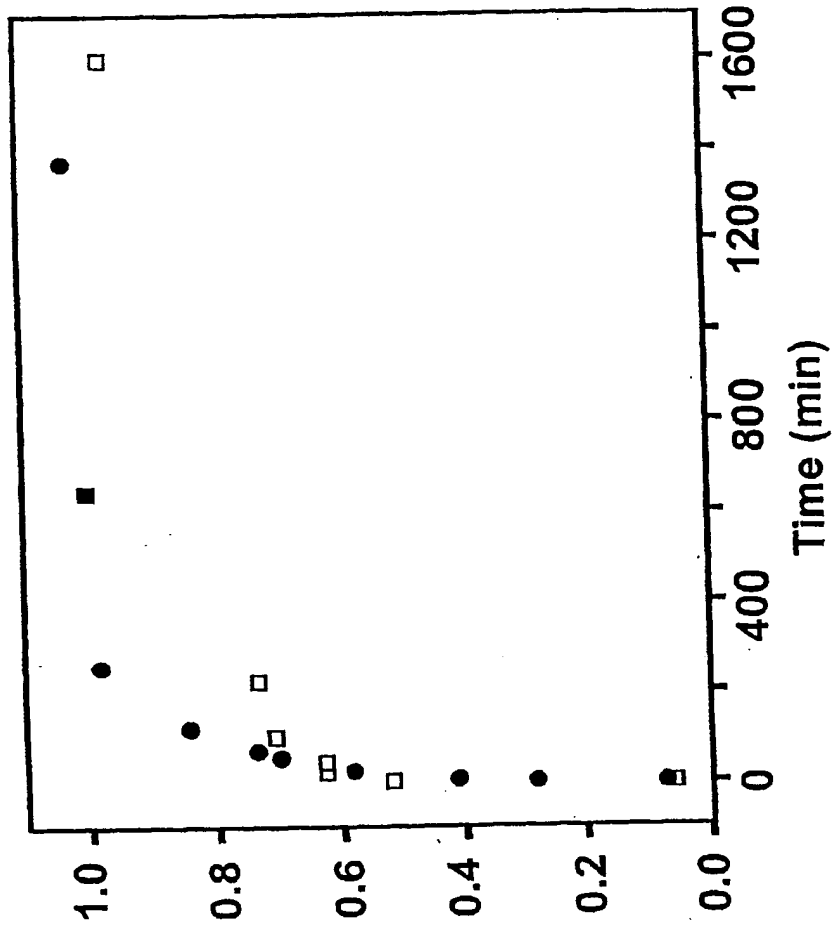

FIG. 29

Fractional Displacement by ME

FIG. 30

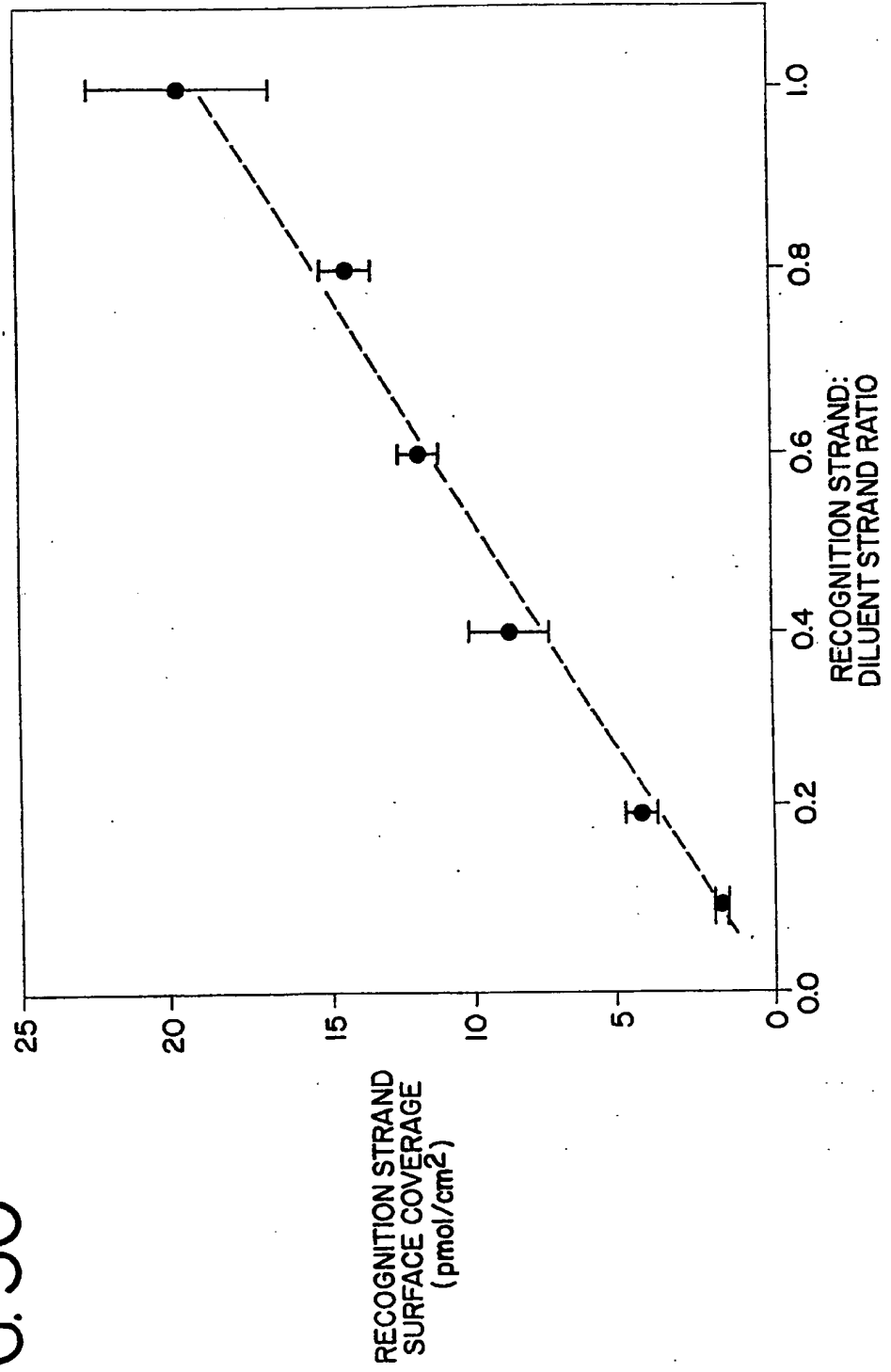
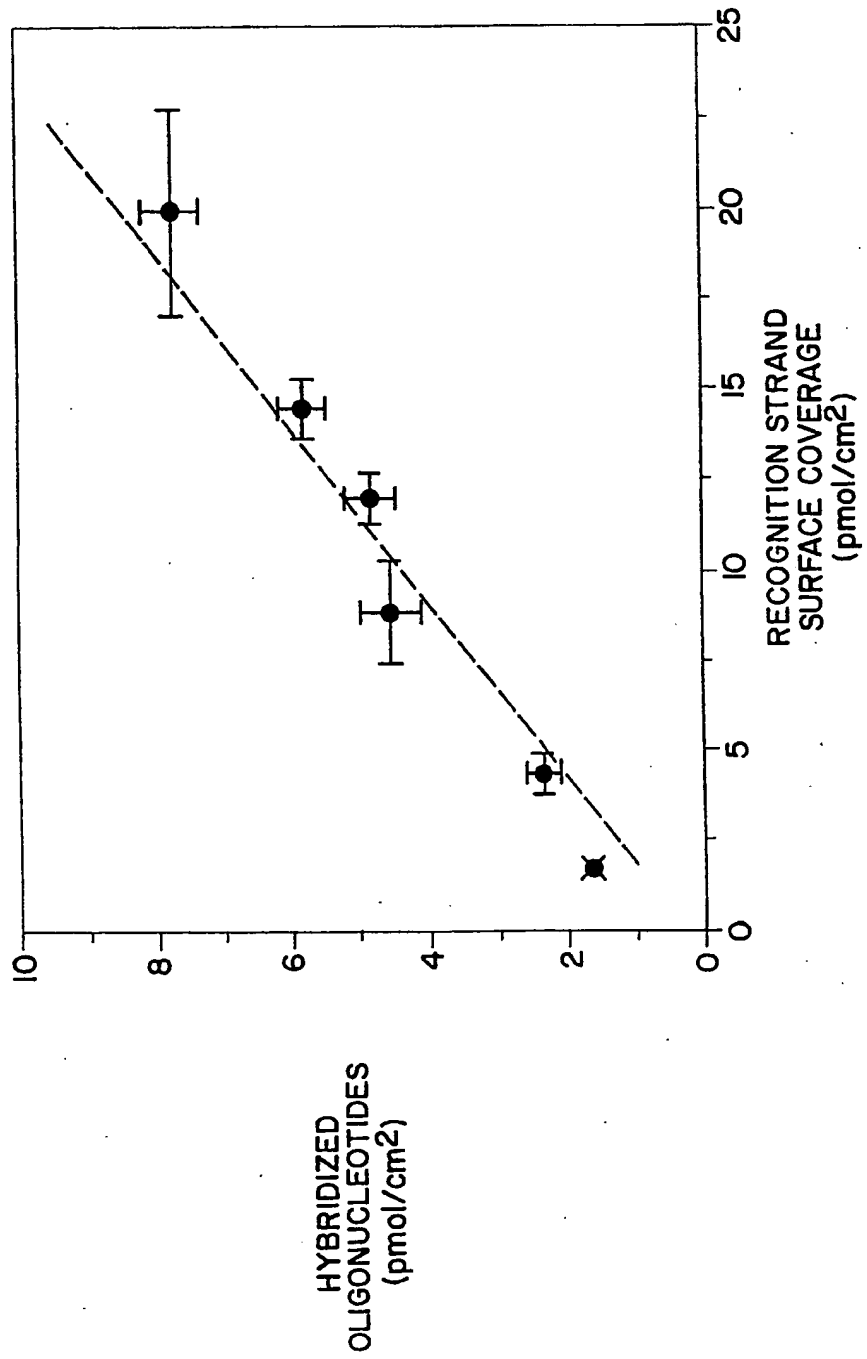
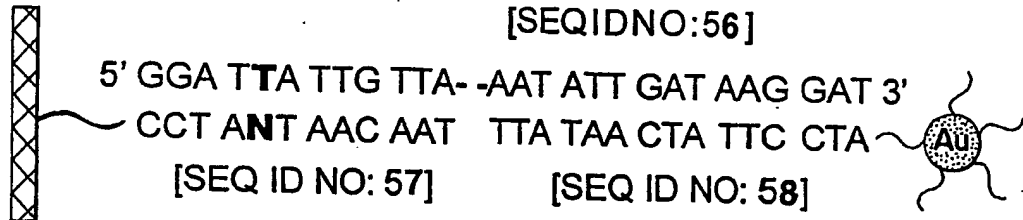

FIG. 31



# FIG. 32



**N** = A (complementary),  
 G,C,T (mismatched)

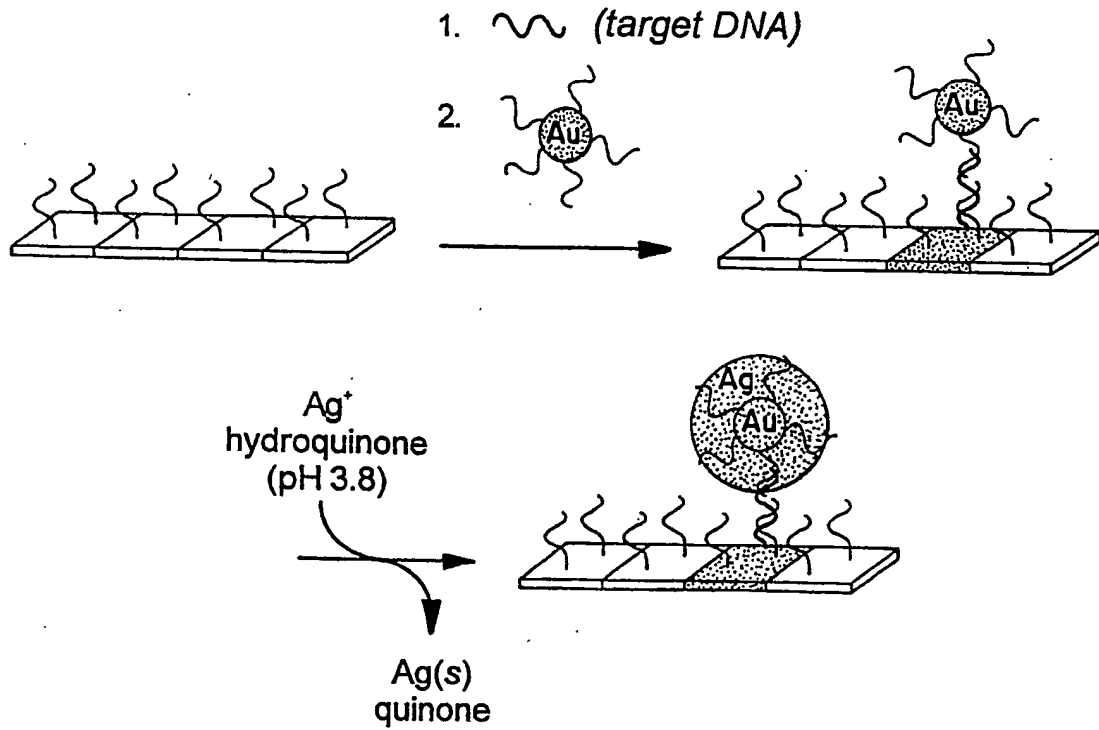

FIG.33

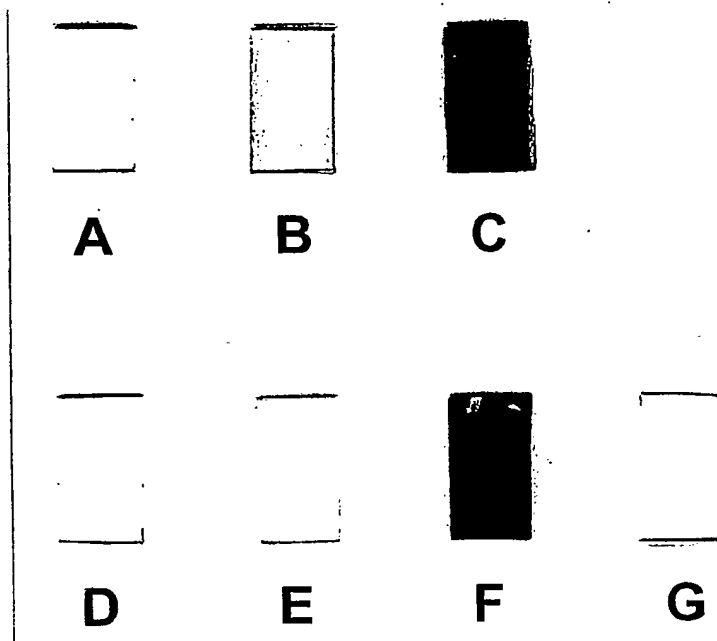
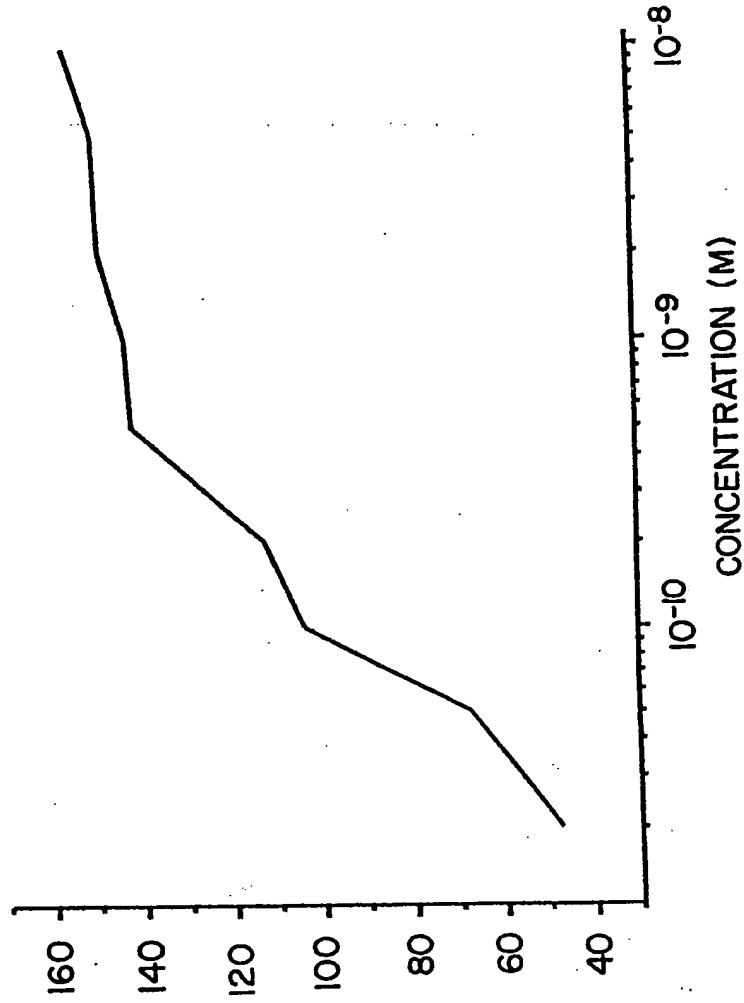

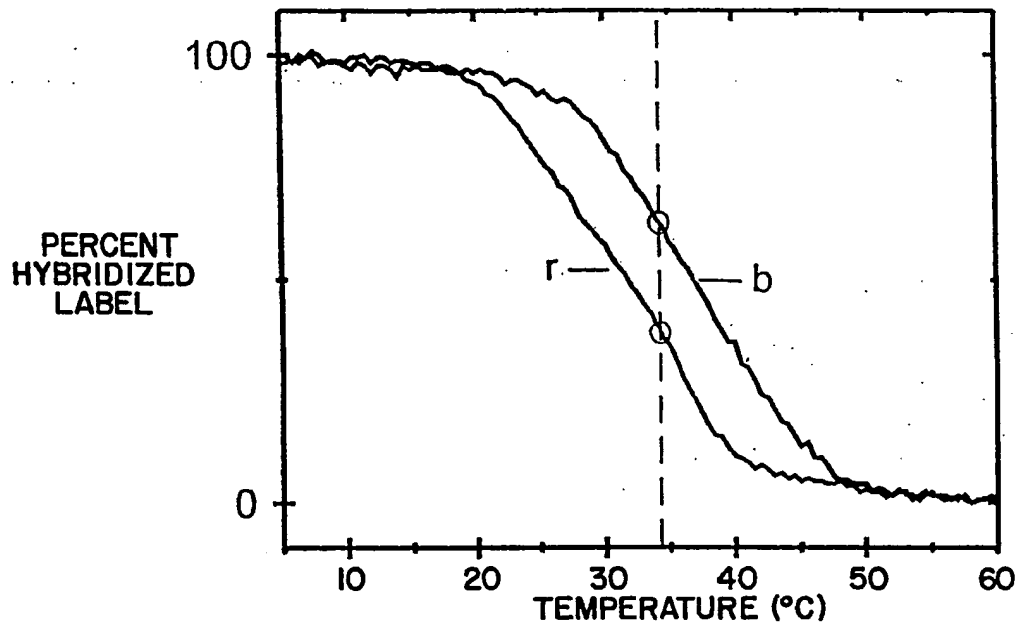

FIG. 34



GREYSCALE, 256-bit

# FIG.35A



# FIG.35B

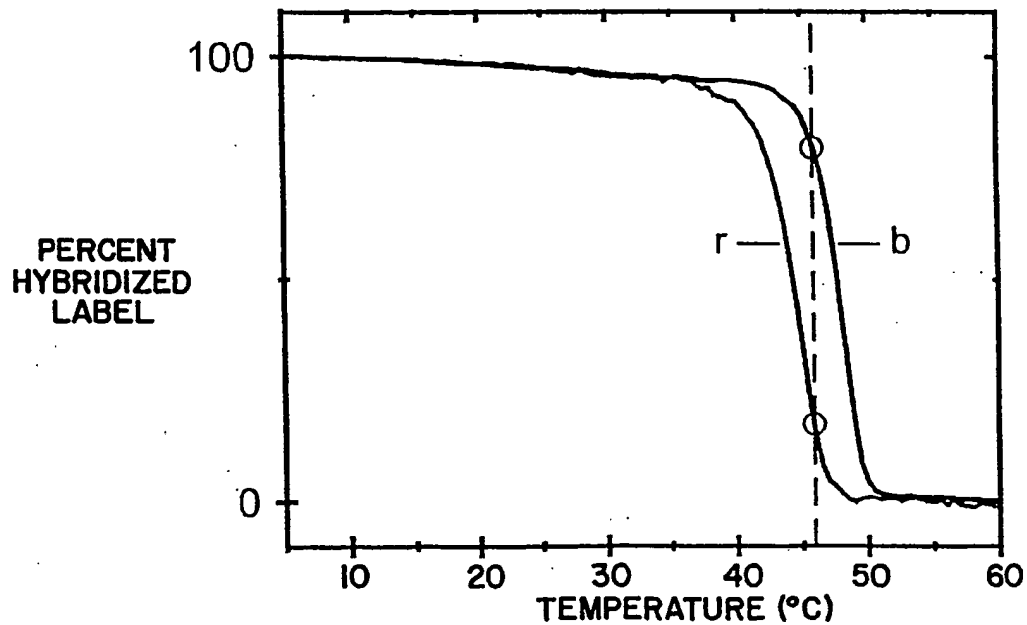

FIG.36A

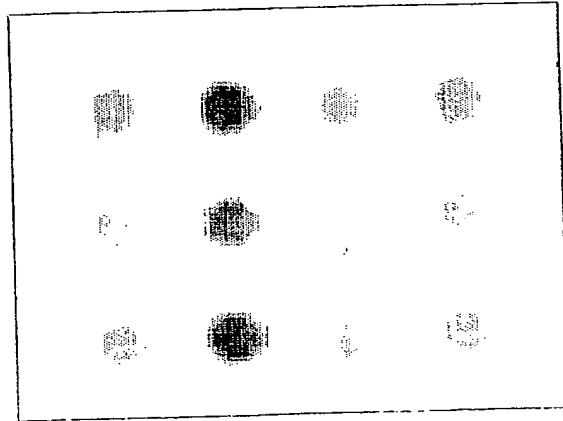
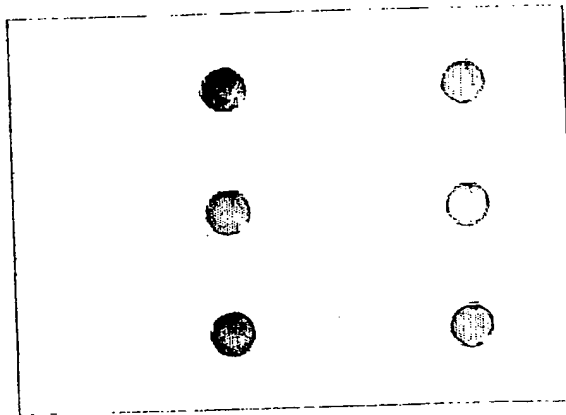

FIG.36B



C A T G

FIG.37A

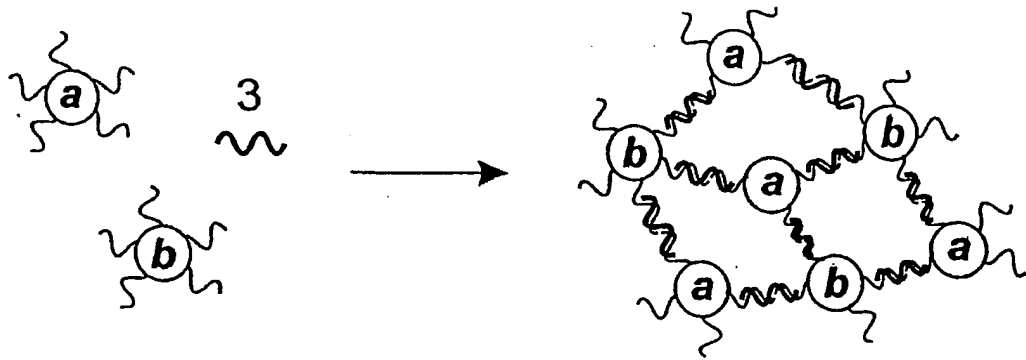
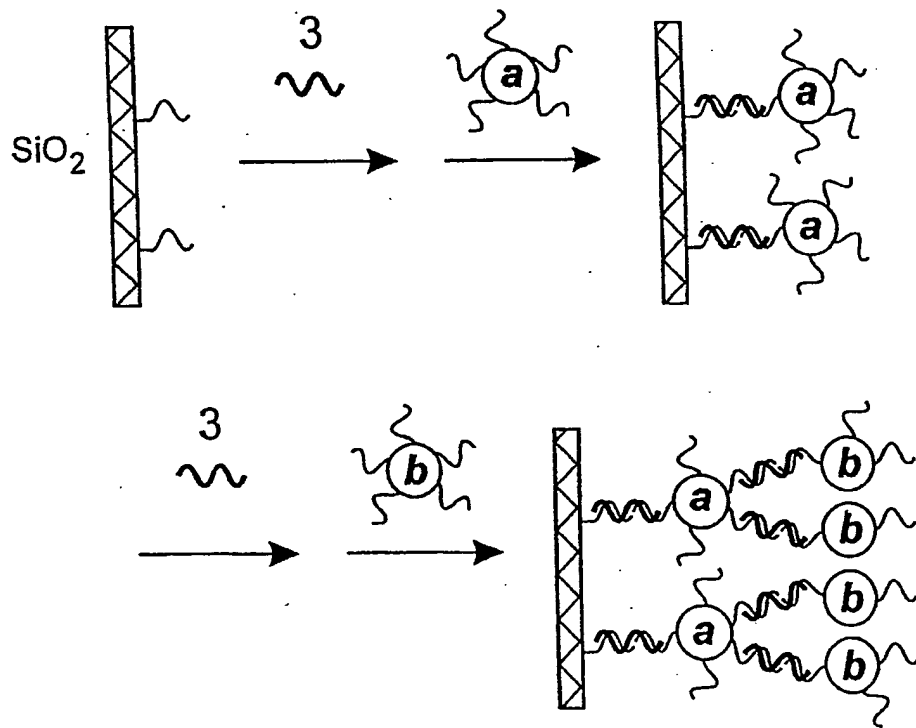
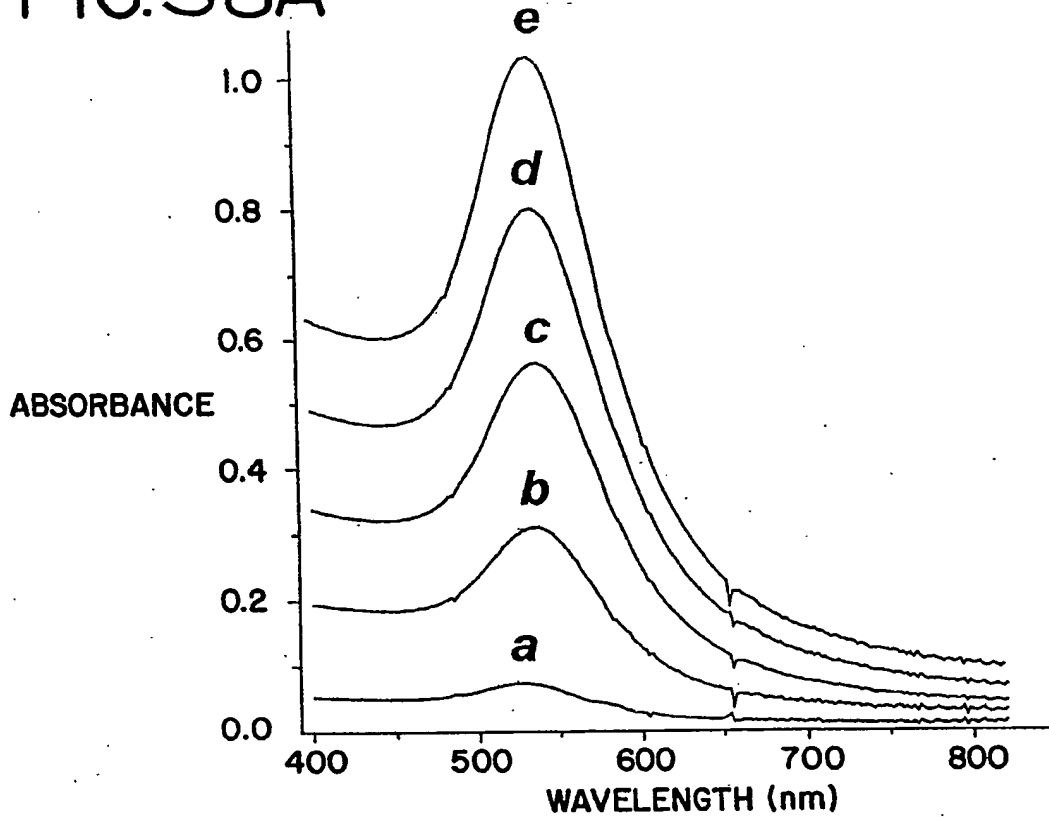

FIG.37B



# FIG. 38A



# FIG. 38B

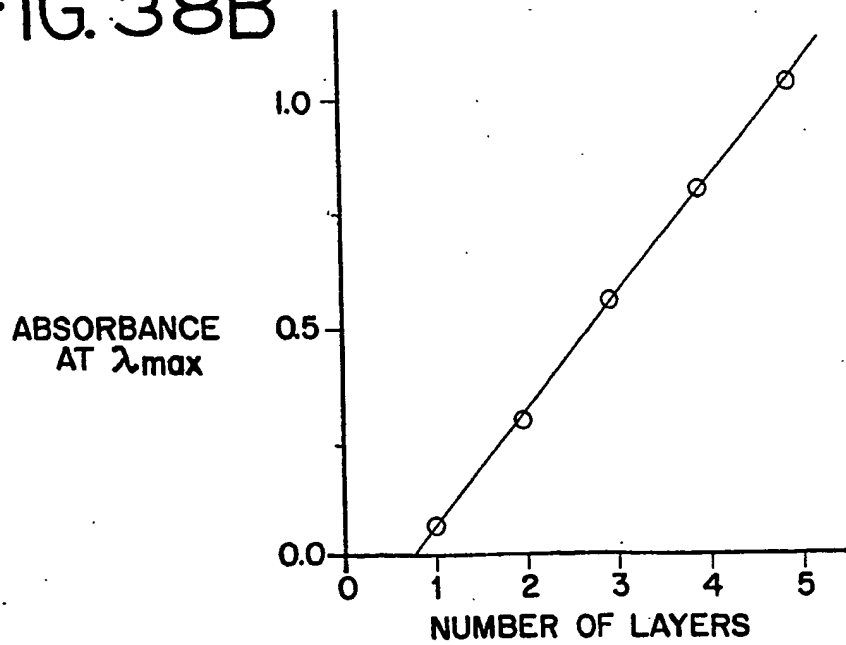

FIG.39A

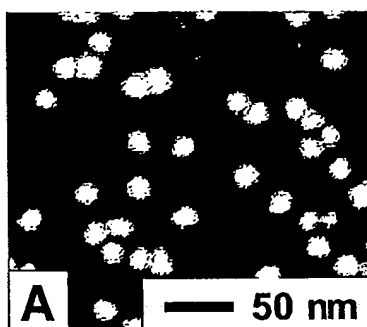

FIG.39B

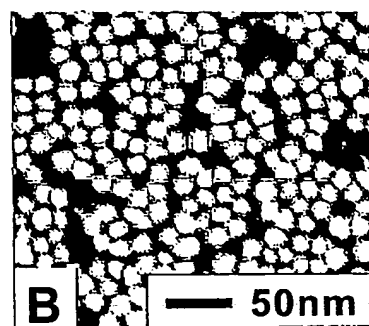

FIG.39C

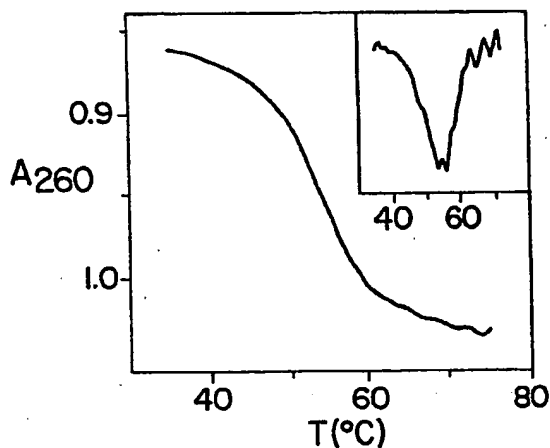

FIG.39D

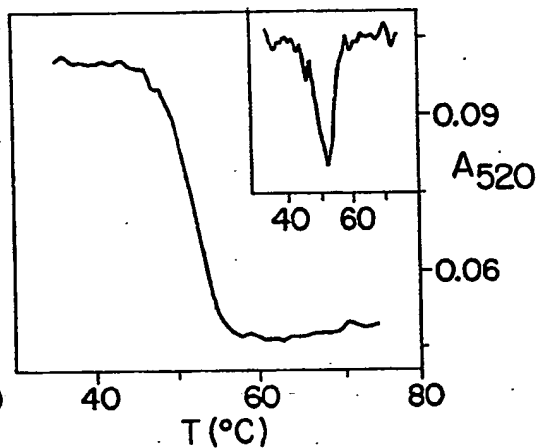

FIG.39E

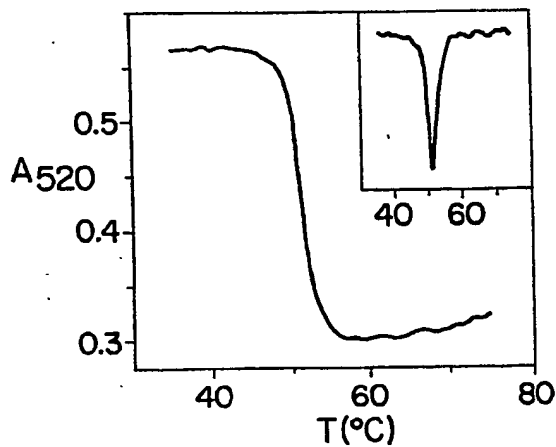

FIG.39F

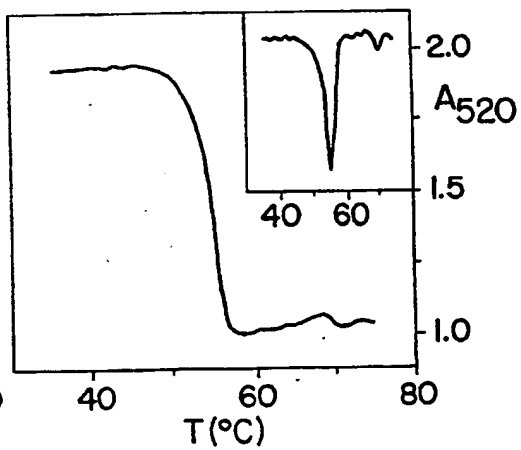

FIG. 40

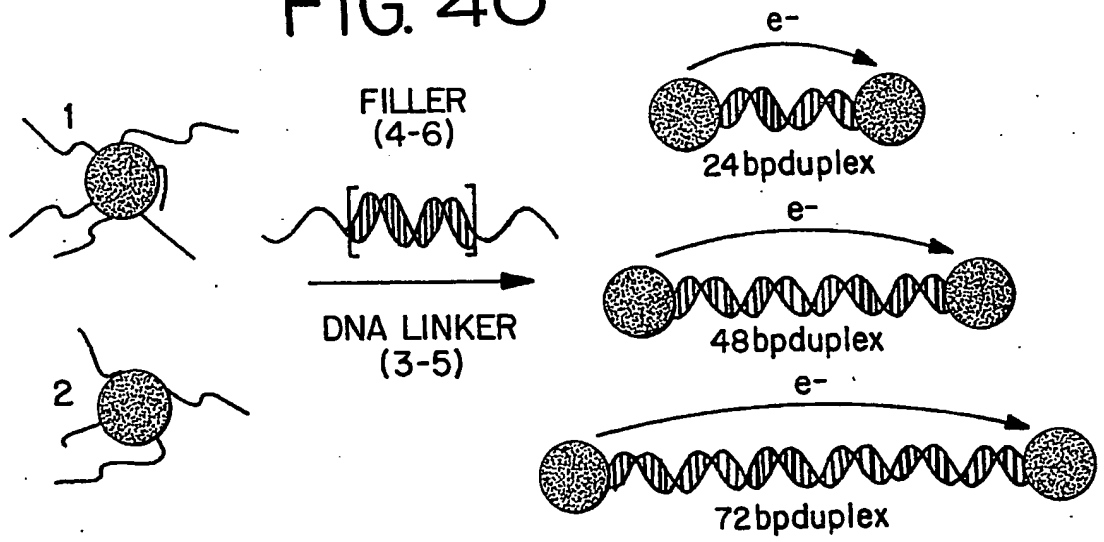
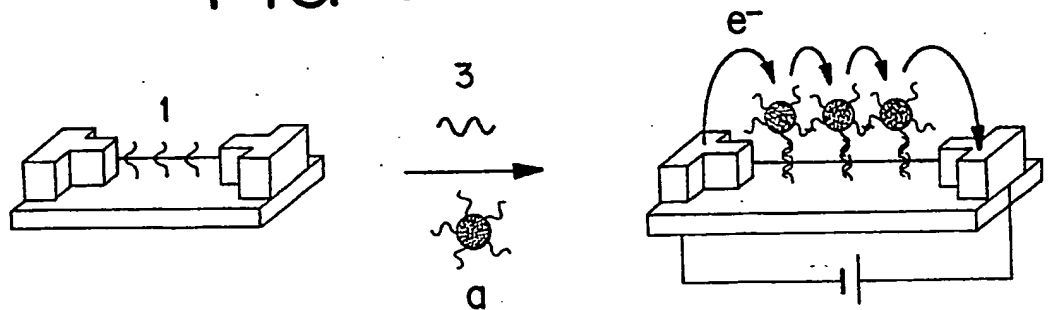
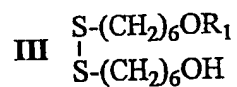
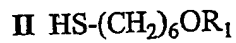
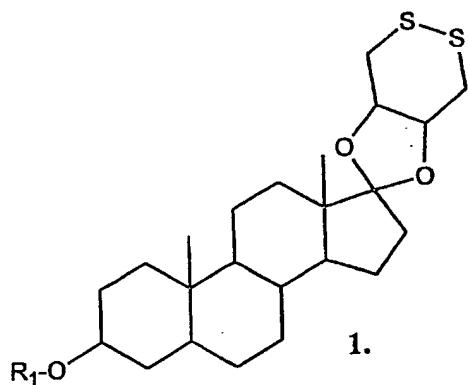

FIG. 41





# FIG. 42



R<sub>1</sub>

a = H

b = (iPr)<sub>2</sub>NP(OCH<sub>2</sub>CH<sub>2</sub>CN)-

c1 = 5'-p(A<sub>20</sub>)-TATCGTTCCATCAGCT [SEQ ID NO: 65]

c2 = 5'-p(A<sub>20</sub>)-TTGATCTTCCGTTCT [SEQ ID NO: 66]

Target I = 79-mer oligonucleotide with target region:

3'-.....ATAGCAAGGTAGTCGAGCAACTAGAAAGGCAAGA.....5'  
[SEQ ID NO: 67]

## FIG. 43

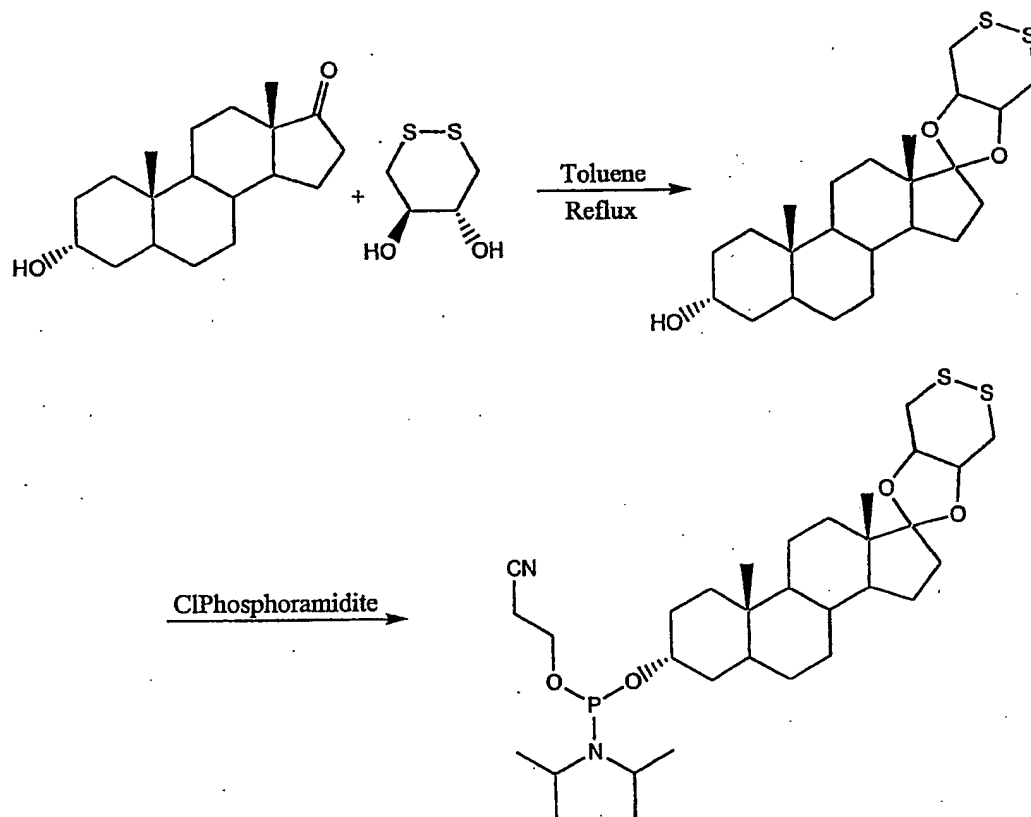

# FIG. 44

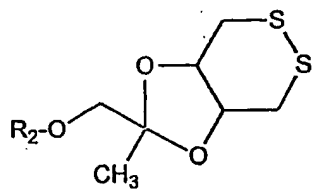

2.

R<sub>2</sub>

a = H

b = (iPr)<sub>2</sub>NP(OCH<sub>2</sub>CH<sub>2</sub>CN)-

c1 = 5'-p(A<sub>20</sub>)-GCAGACCTCA [SEQ ID NO: 68]

c2 = 5'-p(A<sub>20</sub>)-CCTATGTGTCG [SEQ ID NO: 69]

D = 5'-p(A<sub>20</sub>) [SEQ ID NO: 70]

Target I = 63-mer oligonucleotide with target region:

3'-.....CGTCTGGAGTGGATAACACAGC.....5'

[SEQ ID NO: 71]

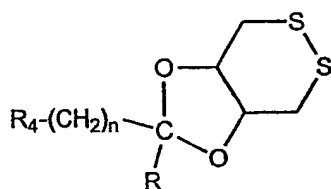

3.

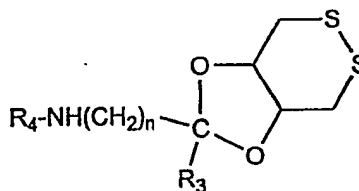

4.

R<sub>3</sub> = hydrogen, an alkyl group, an aryl group, or a substituted alkyl or aryl group

R<sub>4</sub> = an attached oligonucleotide or modified oligonucleotide

# FIG. 45

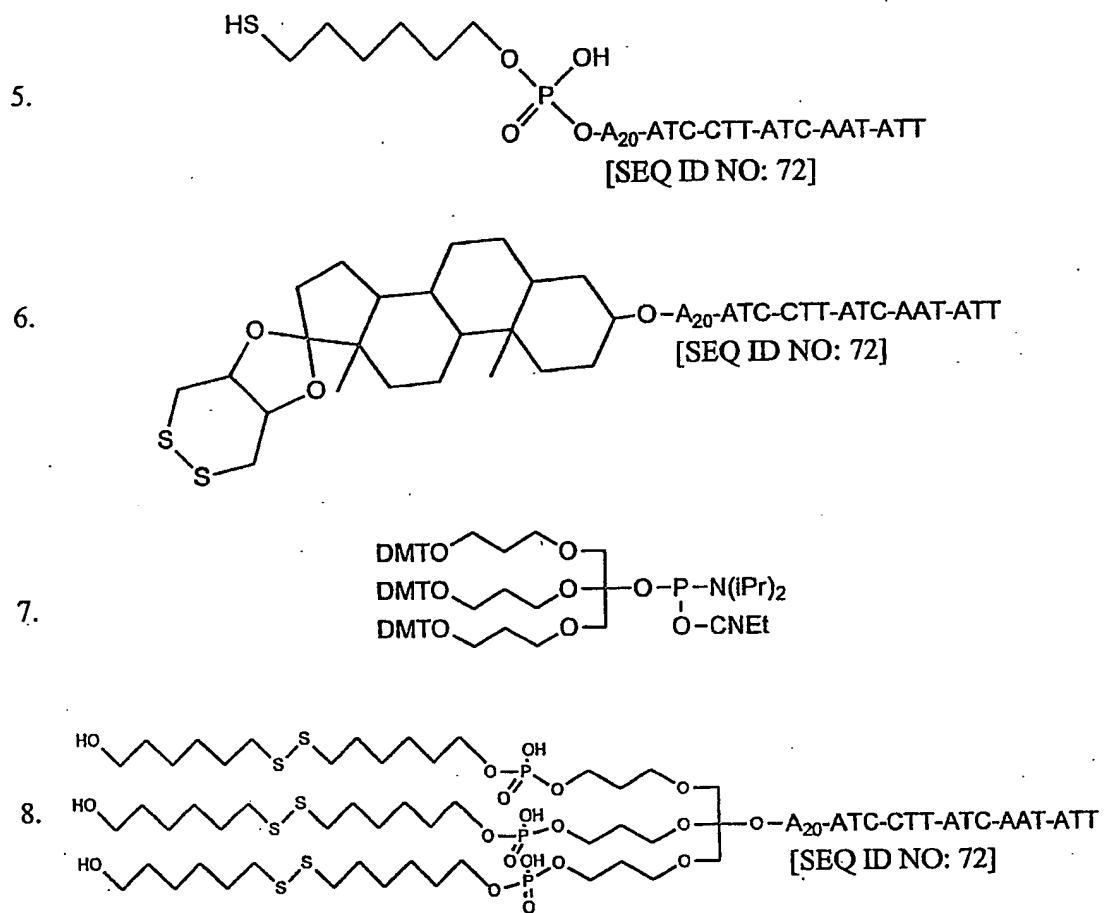
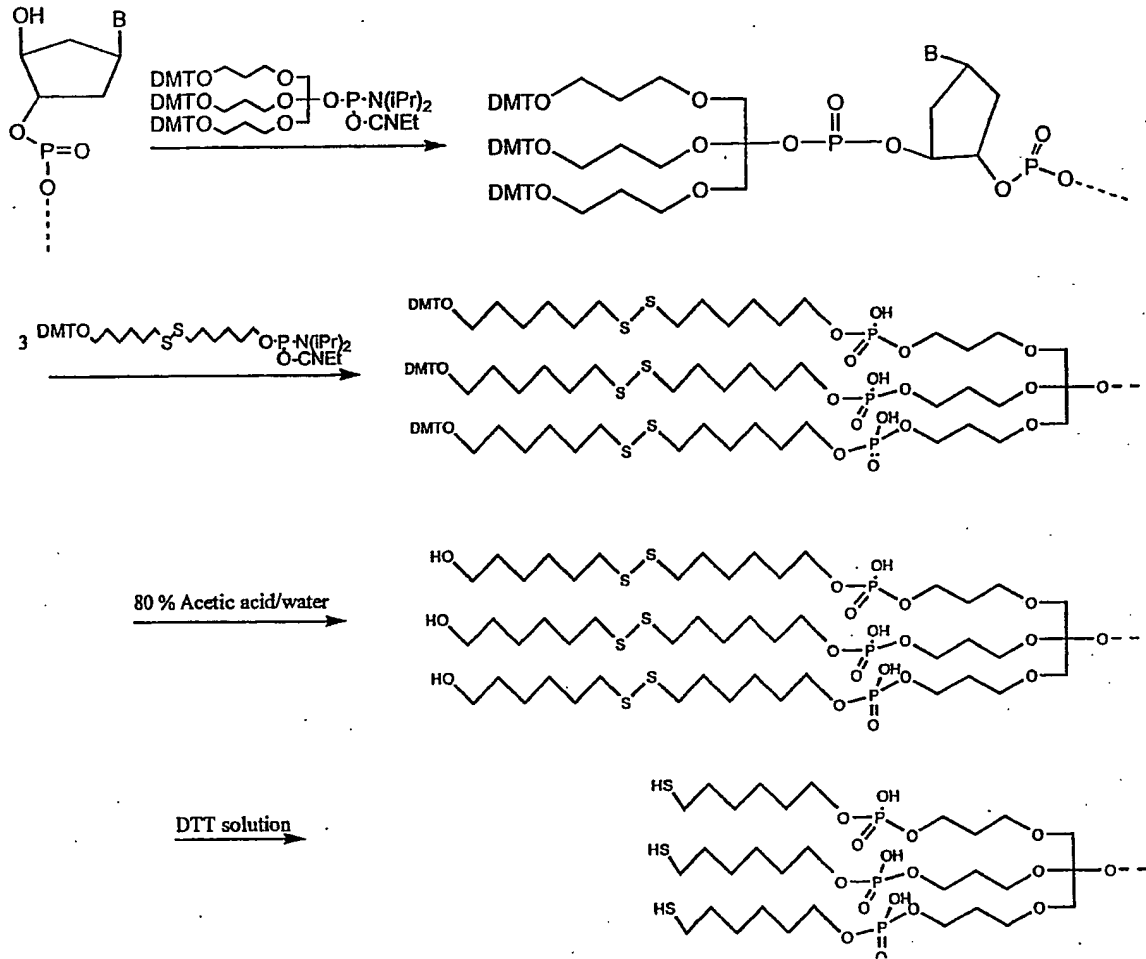

FIG. 46



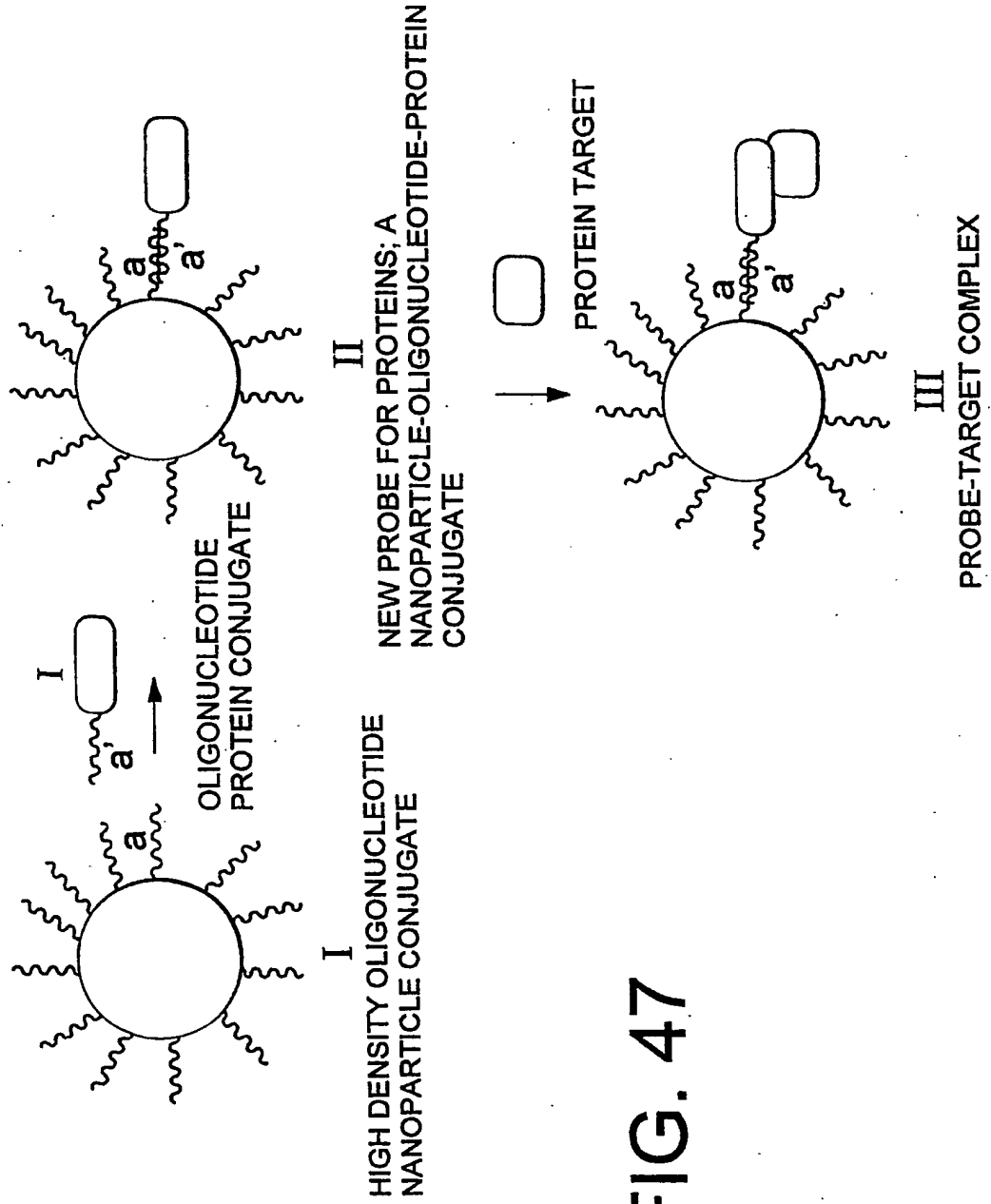
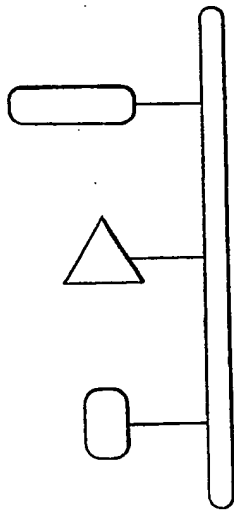
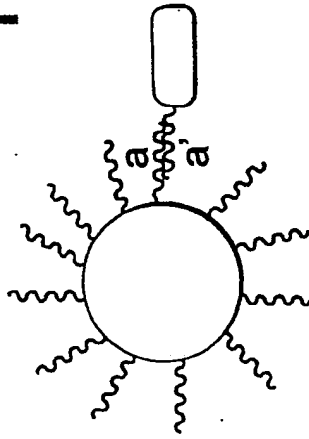

FIG. 47

FIG. 48



GLASS PLATE WITH THREE DIFFERENT PROTEINS IMMOBILIZED ON THE SURFACE, ONE OF WHICH BINDS TO THE PROTEIN IN PROBE II



II

NEW PROBE FOR PROTEINS; A NANOPARTICLE-OLIGONUCLEOTIDE-PROTEIN CONJUGATE

1. EXPOSE PLATE TO THE PROBE SOLUTION
2. WASH AWAY UNBOUND NANOPARTICLE PROBE
3. OBSERVE PRESENCE OF BOUND NANOPARTICLES AT SITE OCCUPIED BY THE FIRST PROTEIN IN THE SERIES.

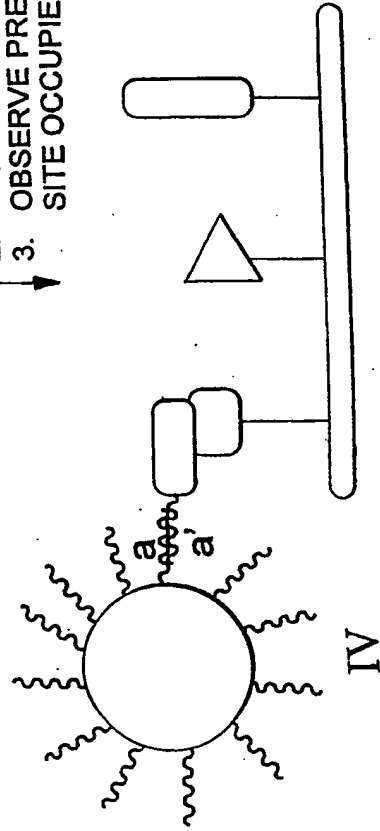

IV

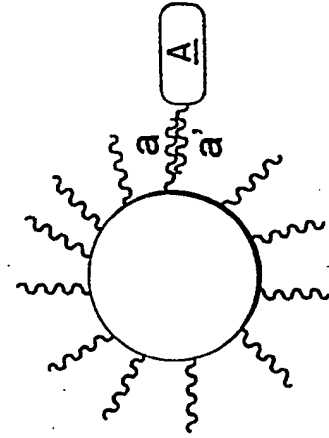

II'

NANOPARTICLE-OLIGONUCLEOTIDE-RECEPTOR

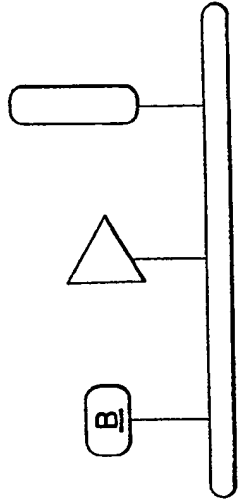

GLASS PLATE WITH THREE DIFFERENT SUBSTANCES  
IMMOBILIZED ON THE SURFACE, ONE OF WHICH (B)  
BINDS TO THE RECEPTOR UNIT (A) IN II'.

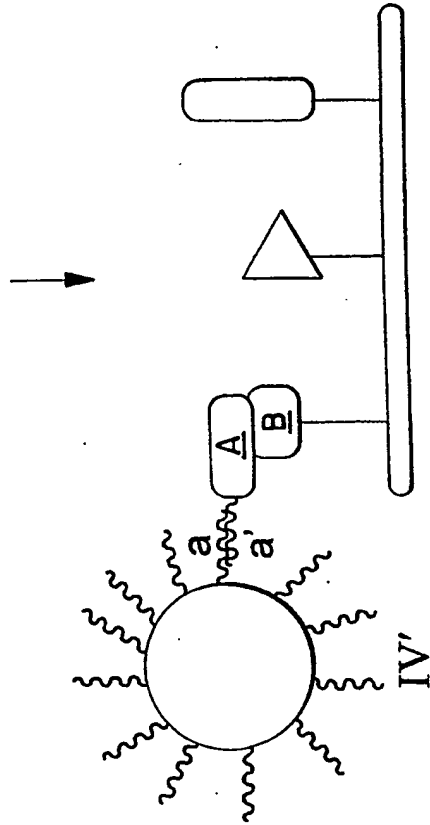

FIG. 49

IV'



FIG. 51A

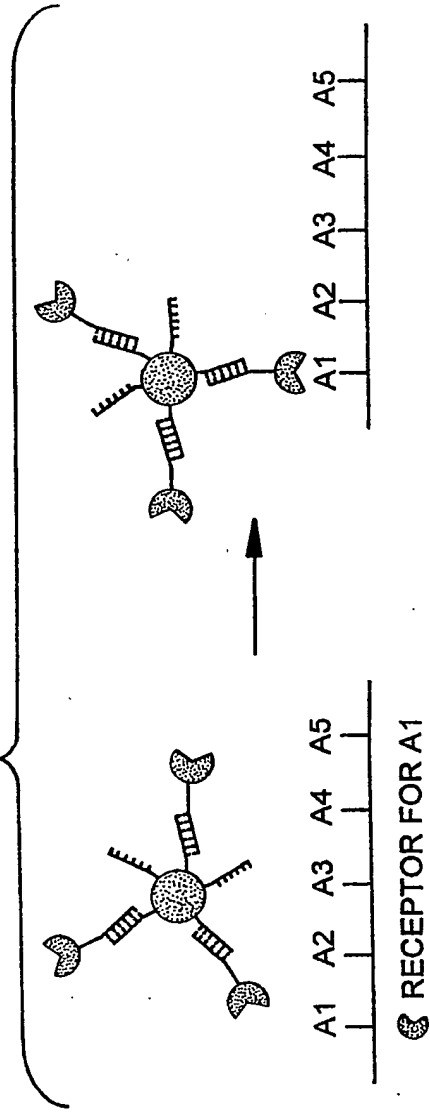

FIG. 51B

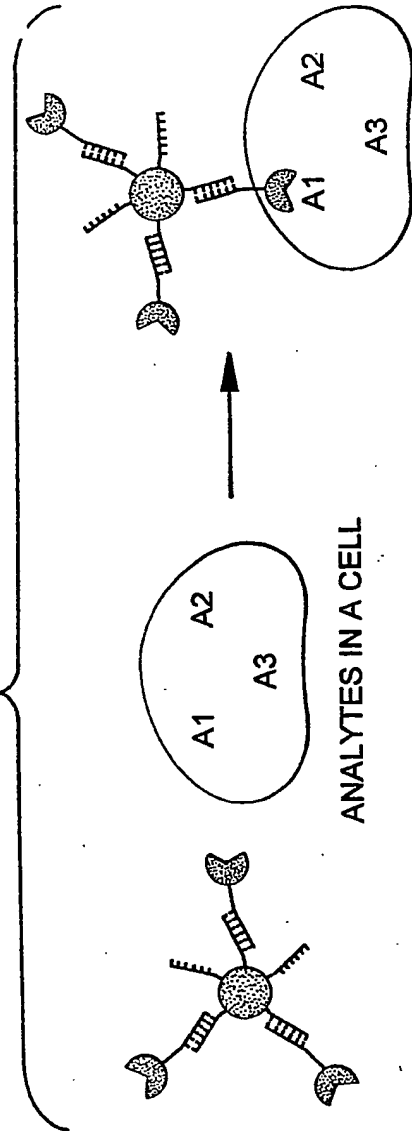

FIG. 50A

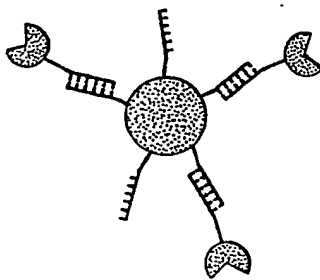

FIG. 50B

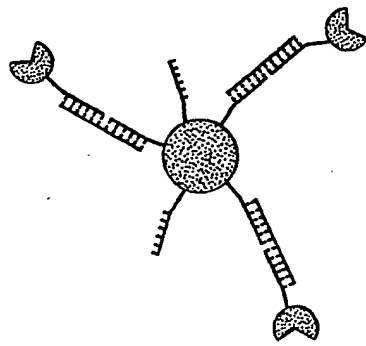
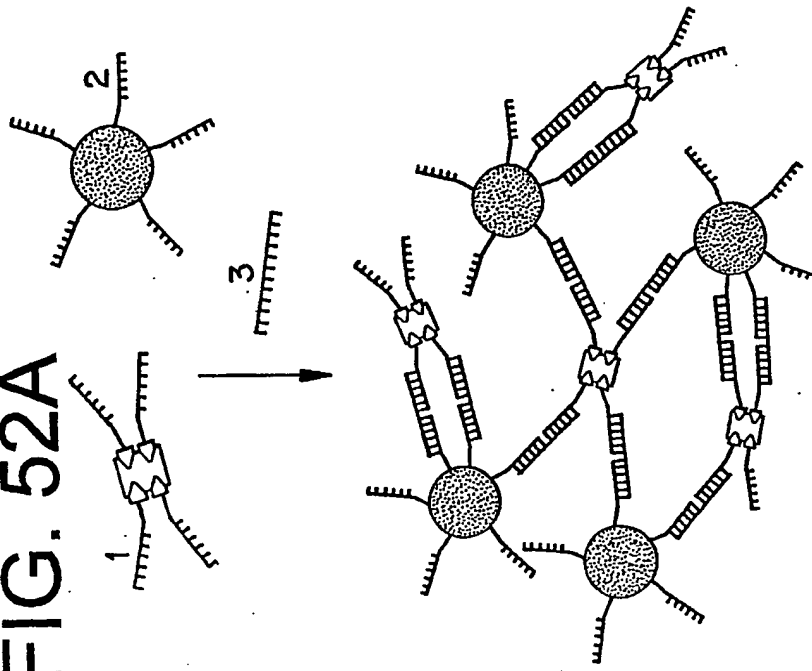

FIG. 52A



- 1 3' biotin-TEG-A10-ATG CTC AAC TCT 5' [SEQ. ID NO. 73]
- 2 5' SH(CH2)6-A10-CGC ATT CAG GAT 3' [SEQ. ID NO. 74]
- 3 5' TAC GAG TTG AGA ATC CTG AAT GCG 3' [SEQ. ID NO. 75]

● 13 nm AU NANOPARTICLES     STREPTAVIDIN

FIG. 52B

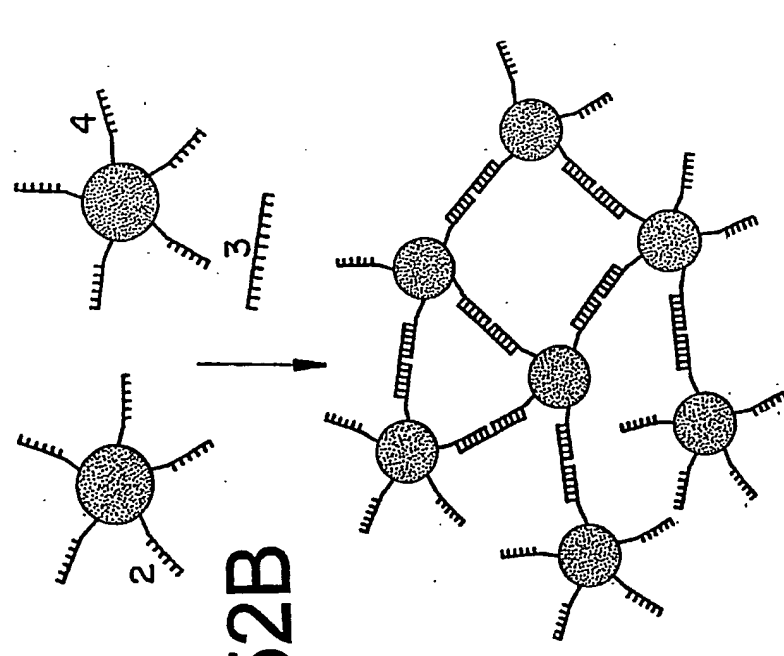

- 2 5' SH(CH2)6-A10-CGC ATT CAG GAT 3'
- 3 5' TAC GAG TTG AGA ATC CTG AAT GCG 3'
- 4 3' SH(CH2)3-A10-ATG CTC AAC TCT 5'

● 13 nm AU NANOPARTICLES

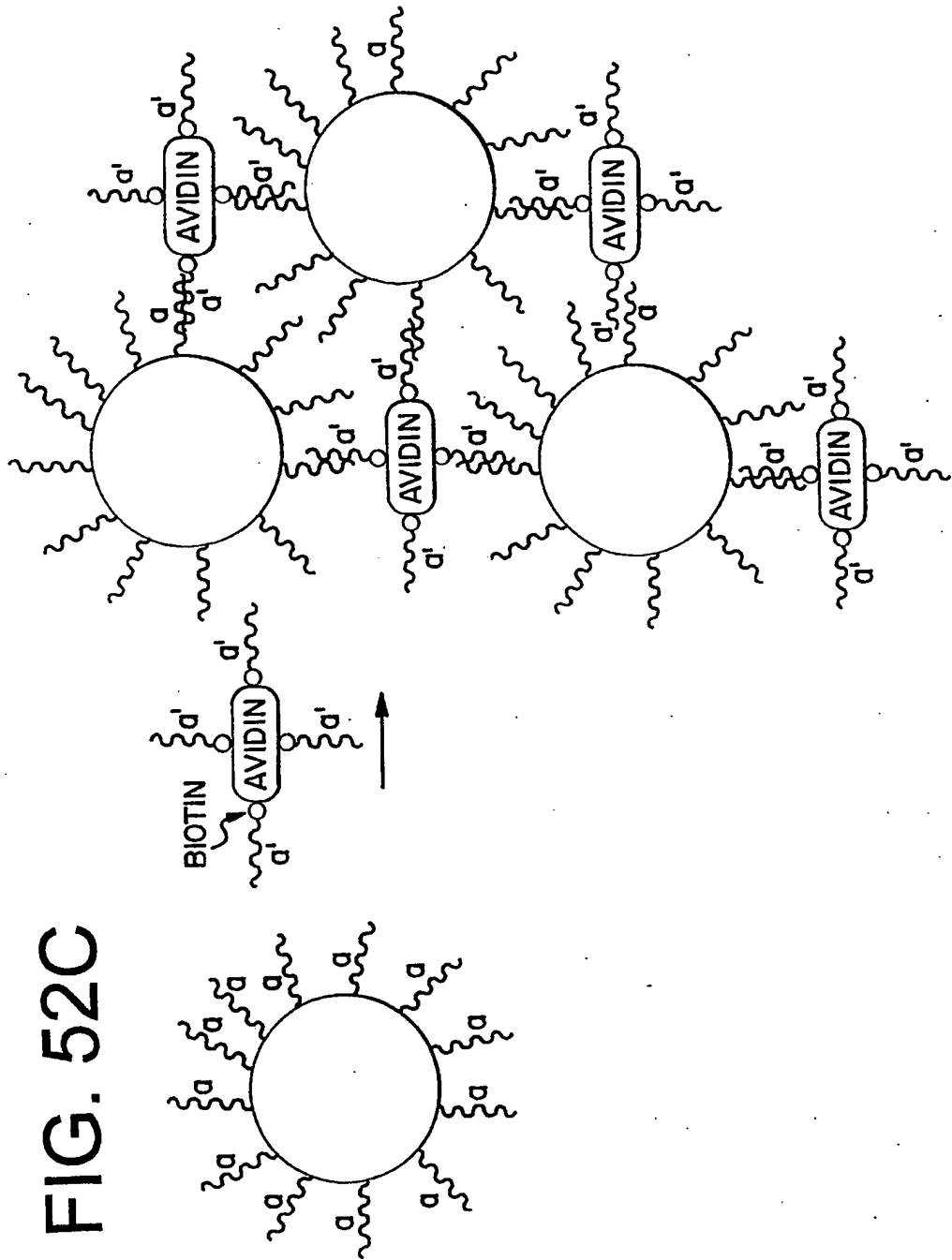
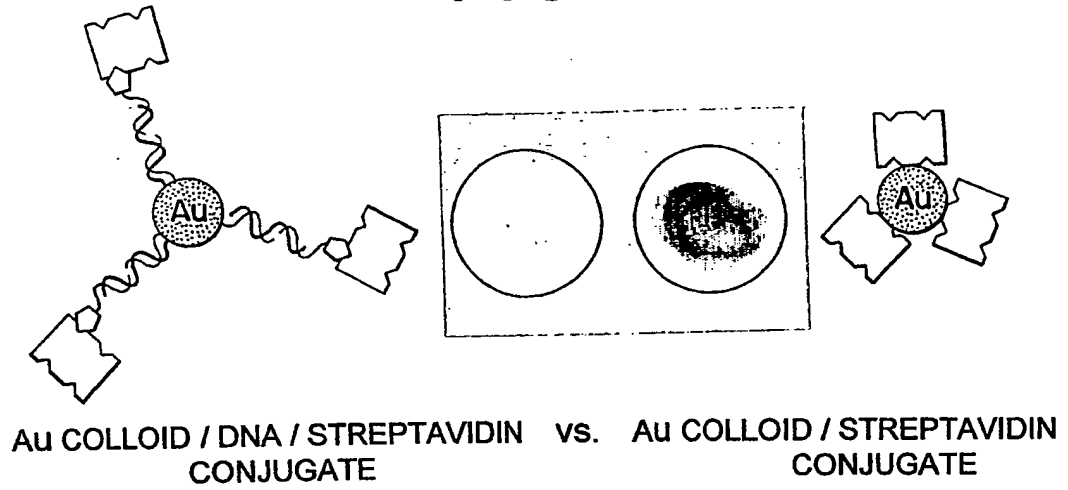

FIG. 52C

# FIG. 53



# FIG. 54

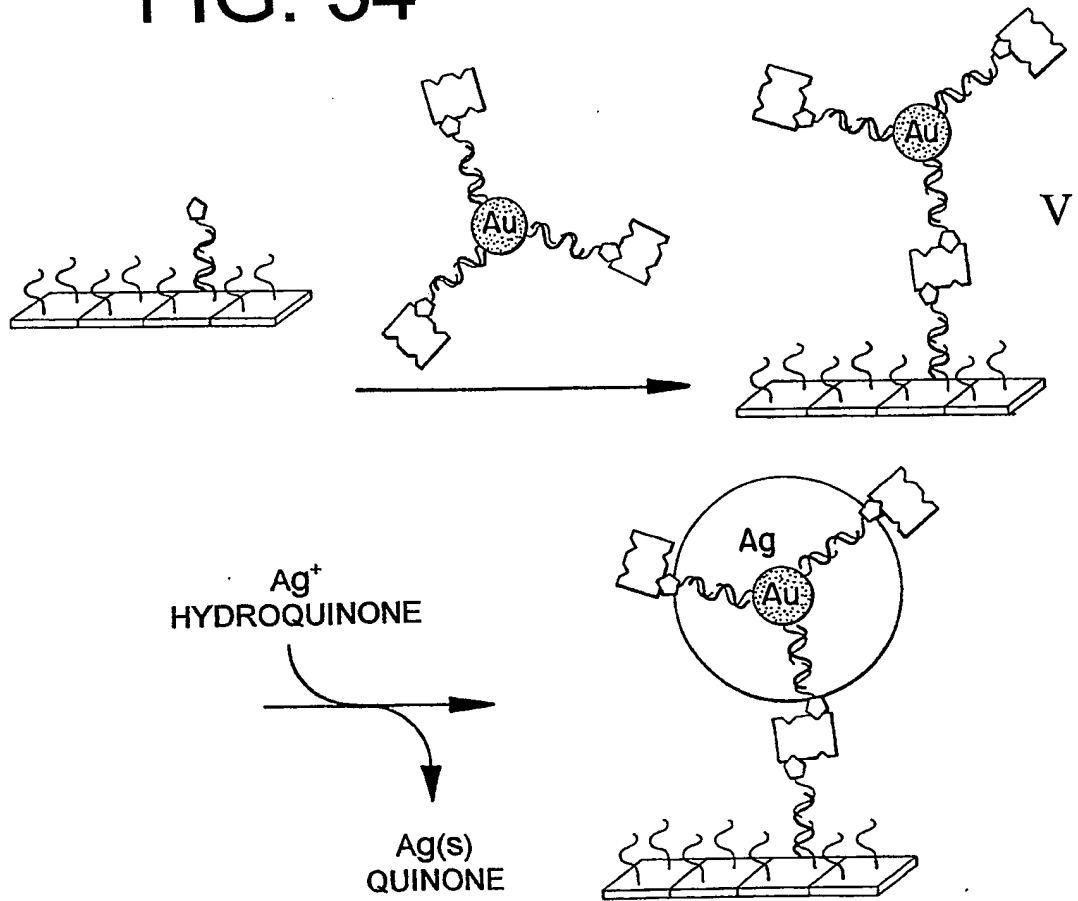

FIG. 55

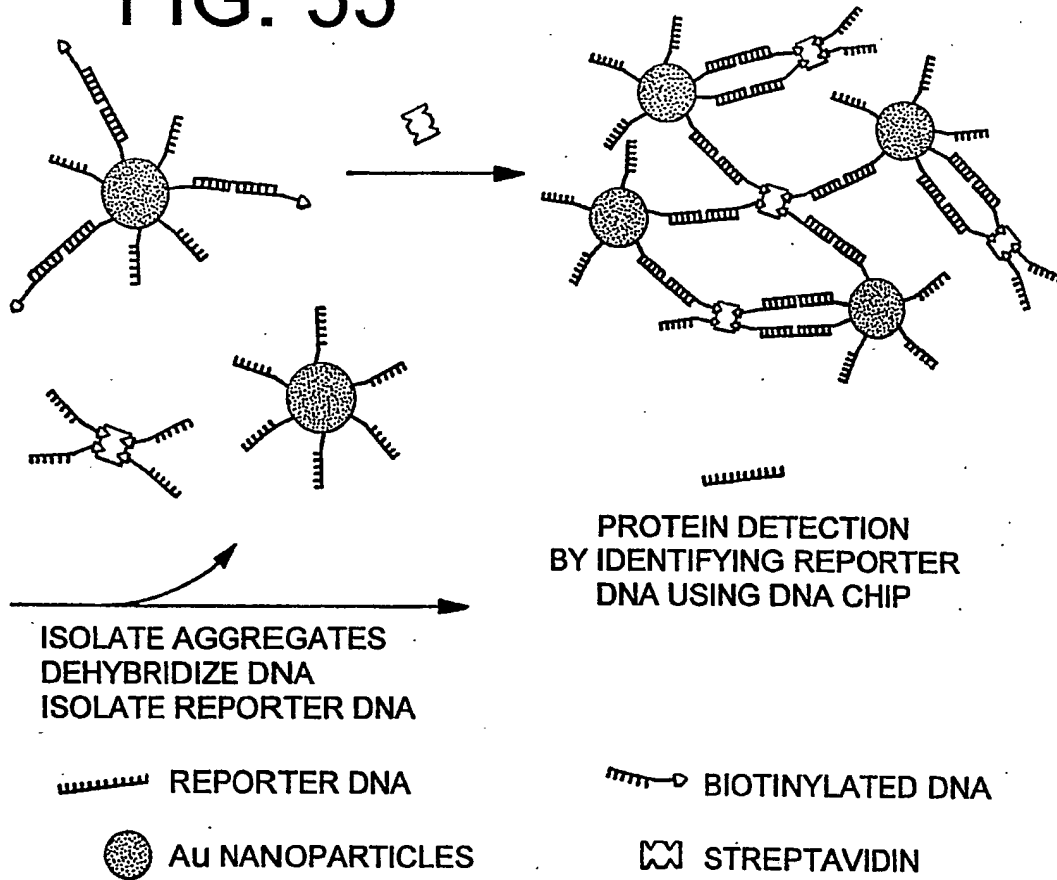

FIG. 56

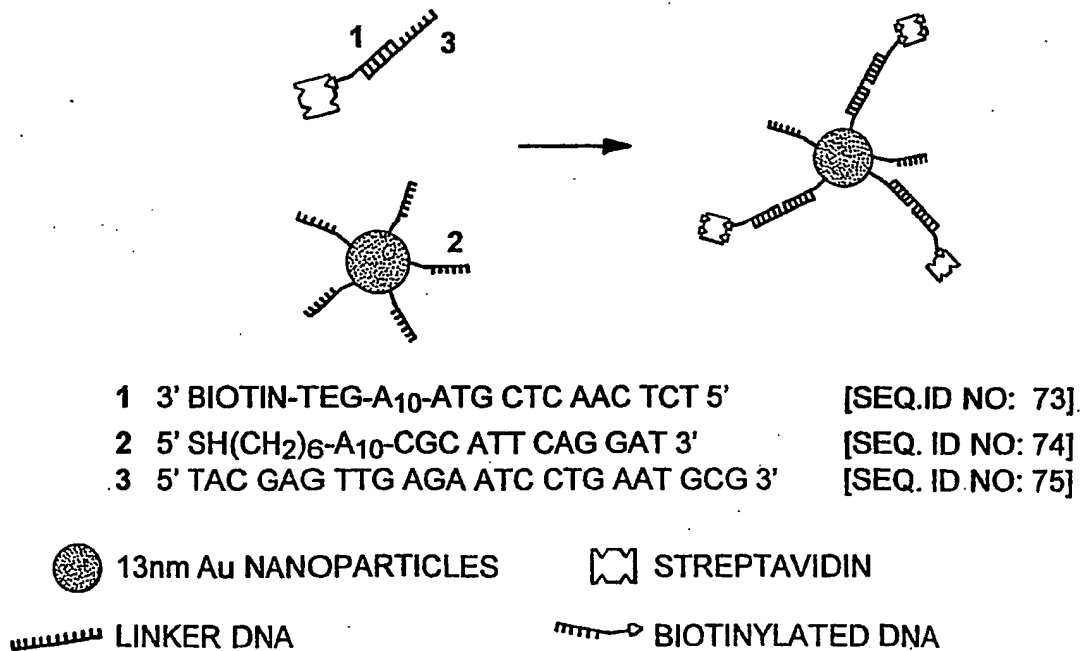

FIG. 57A

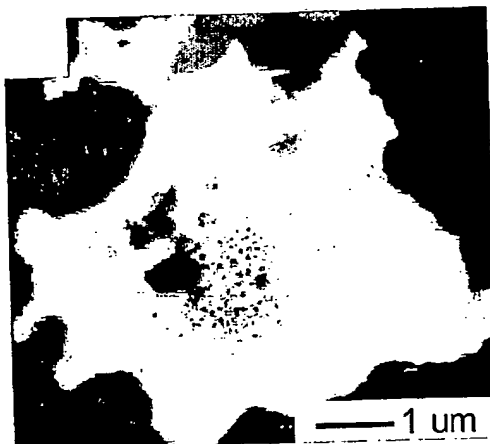
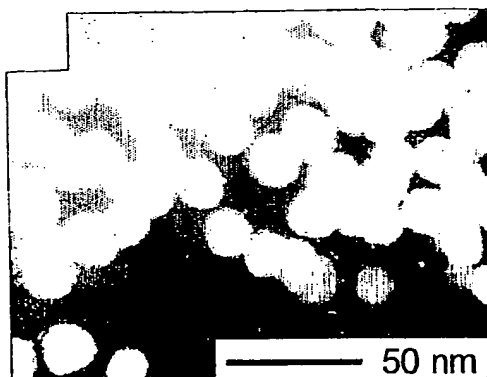
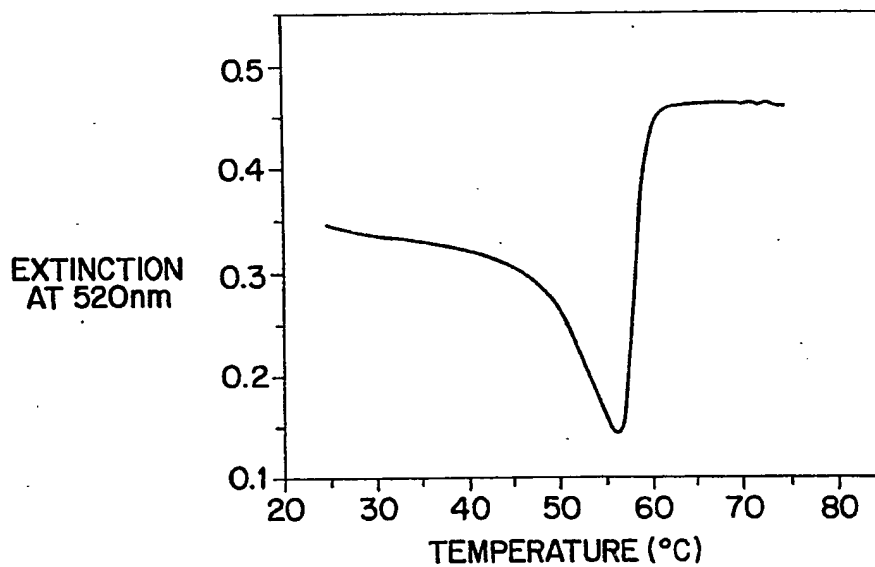

FIG. 57B



# FIG. 58A



# FIG. 58B

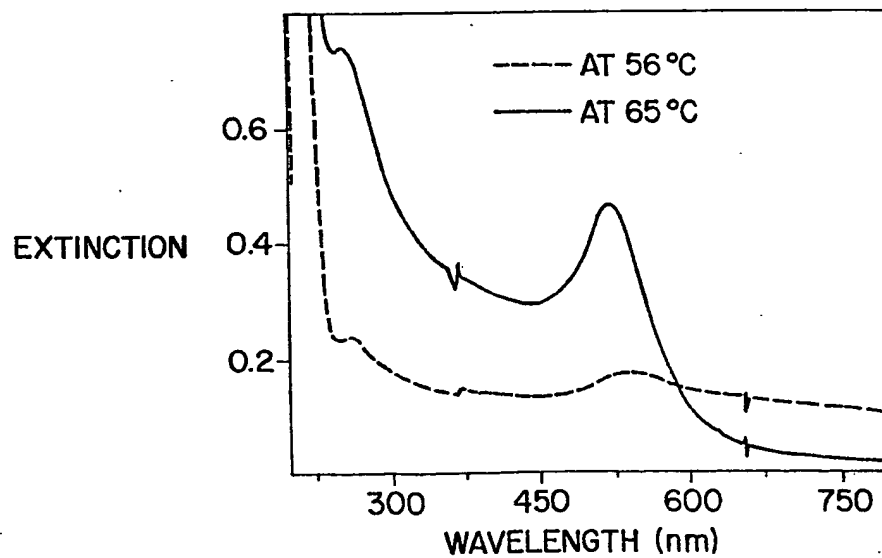
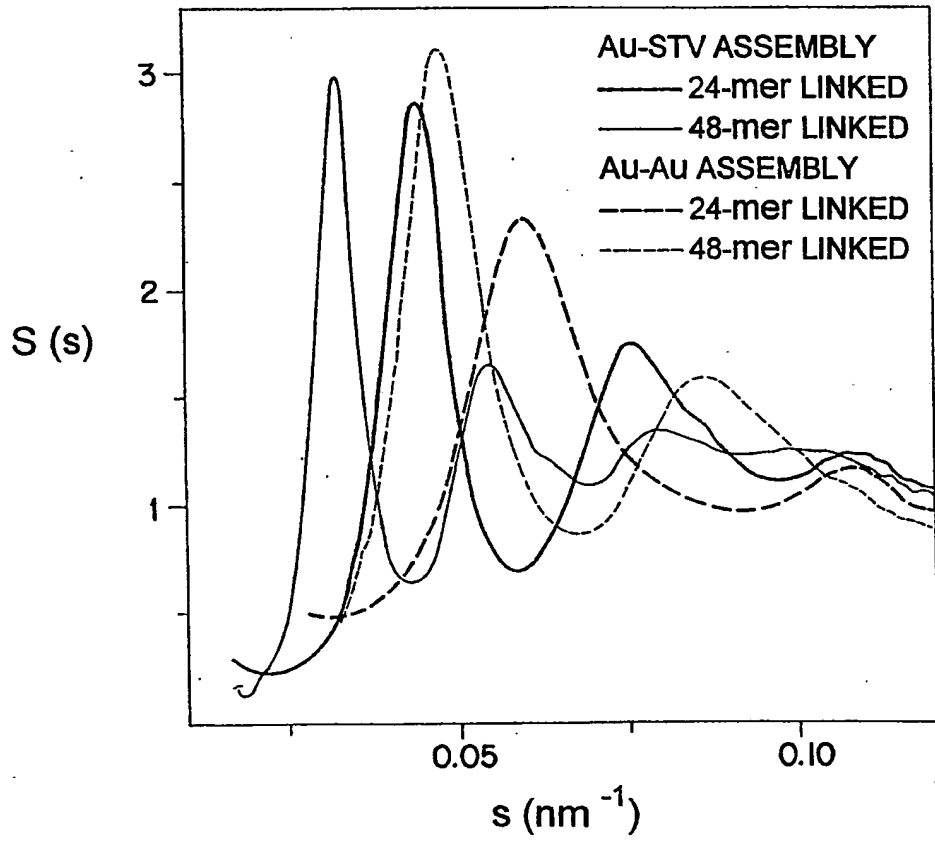

FIG. 59





# FIG. 60

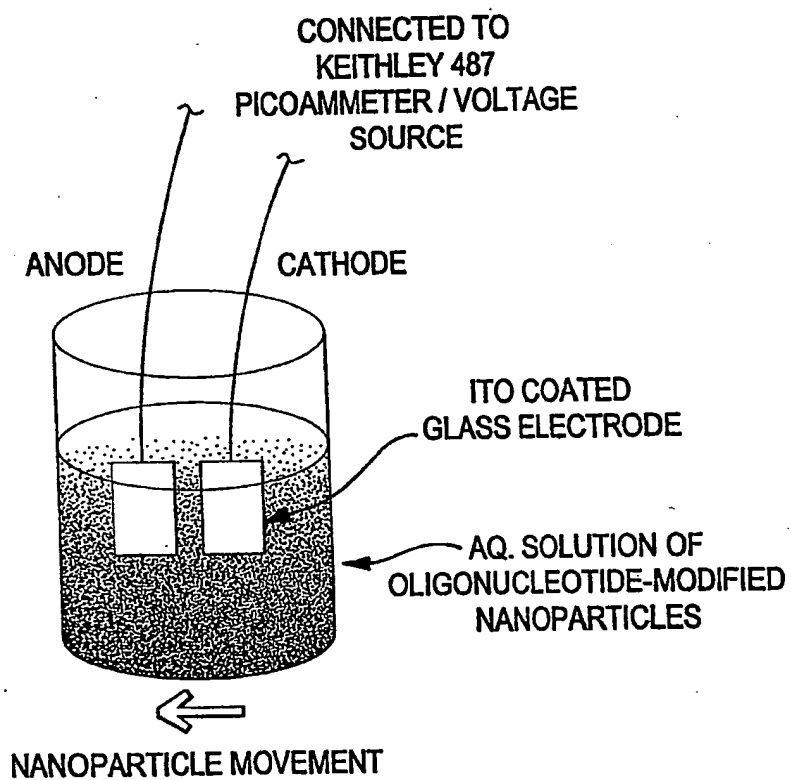

FIG. 61A

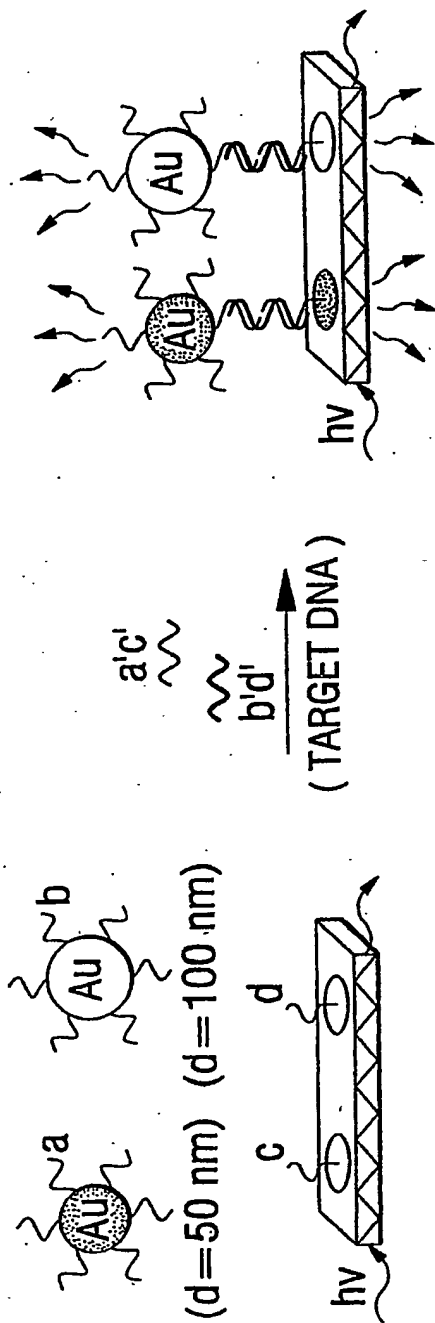
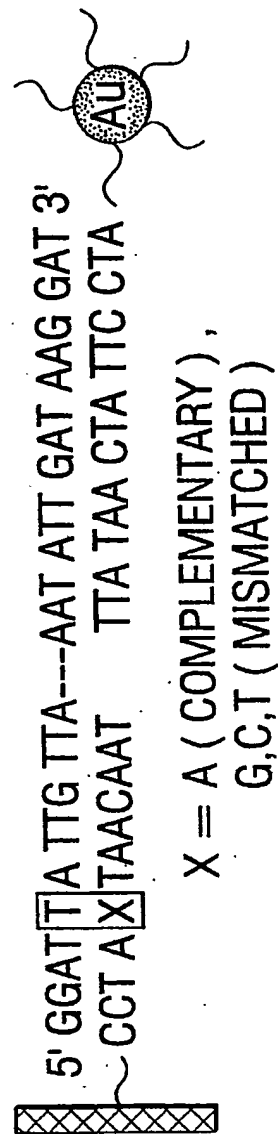

FIG. 61B



# FIG. 62

Test for Target  
Sequence *a'c'*

Test for Target  
Sequence *b'd'*

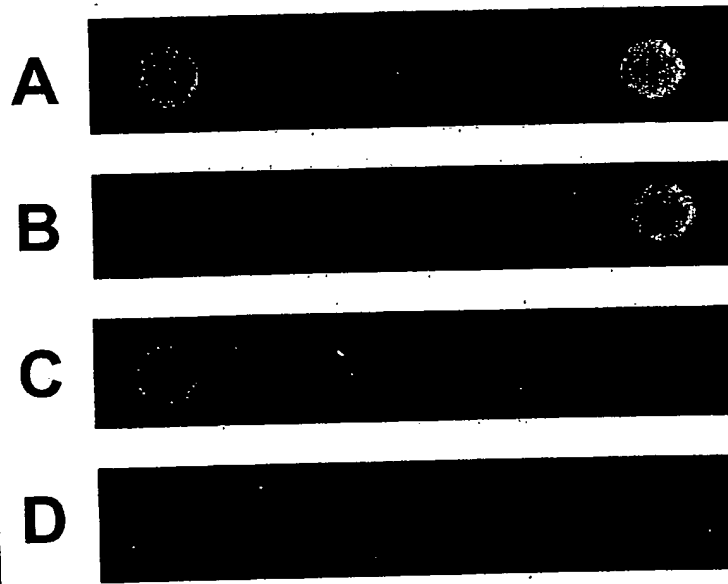
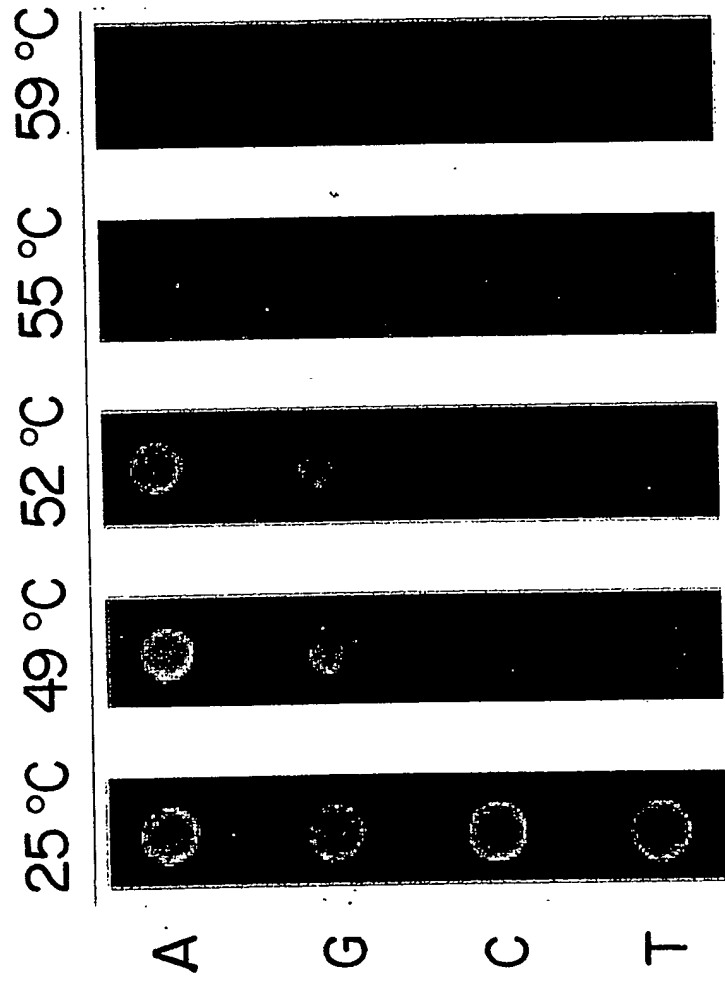
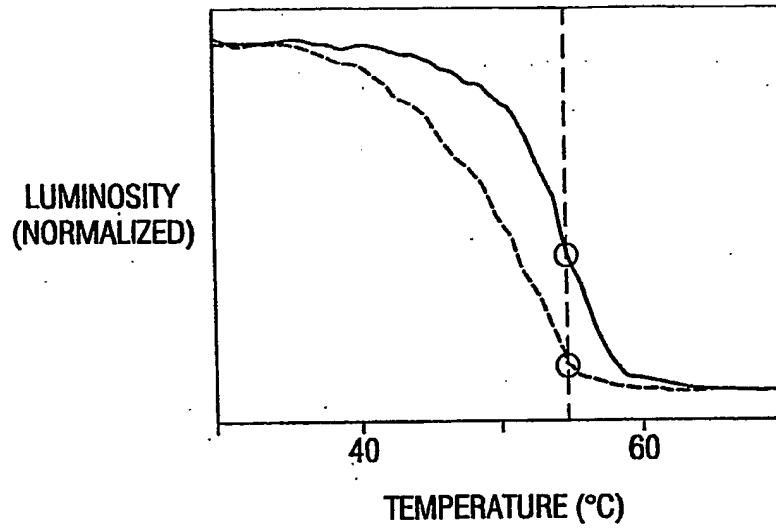

FIG. 63A



# FIG. 63B



# FIG. 64

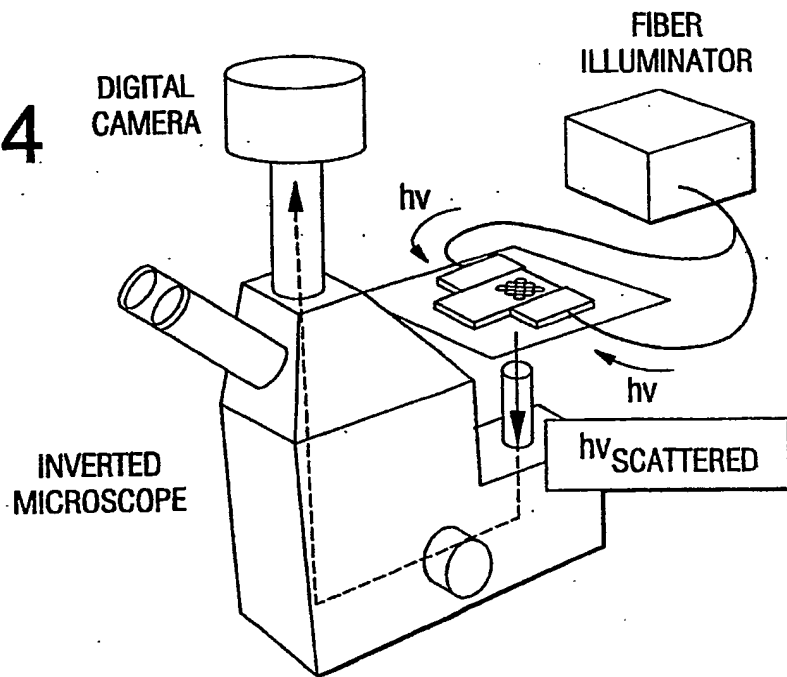

FIG. 65A

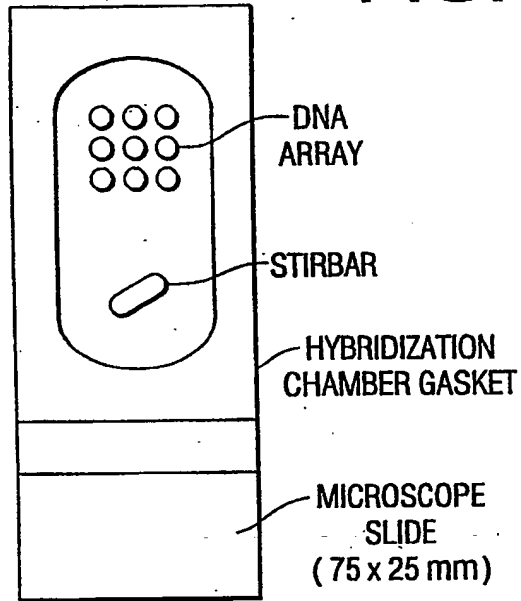
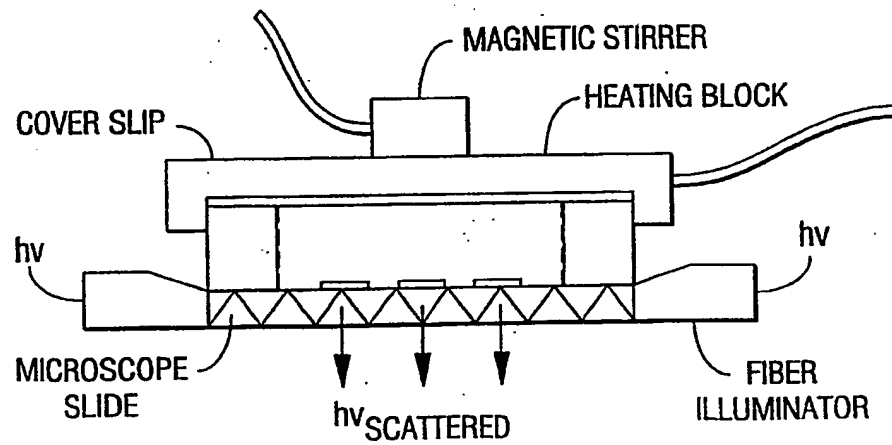
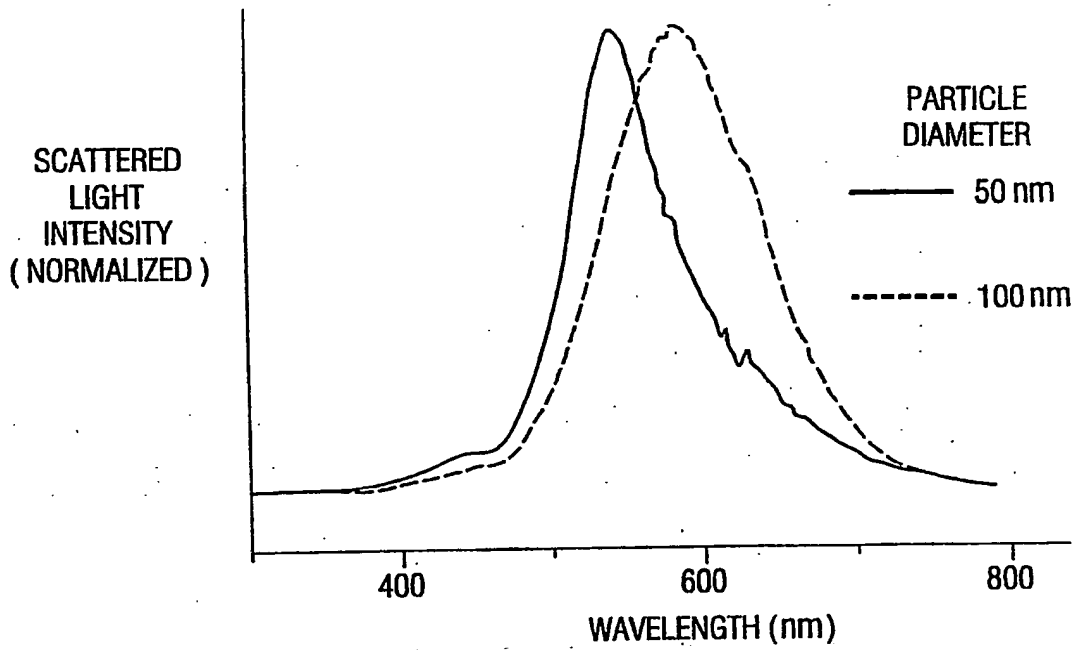

FIG. 65B



# FIG. 66



# FIG. 67

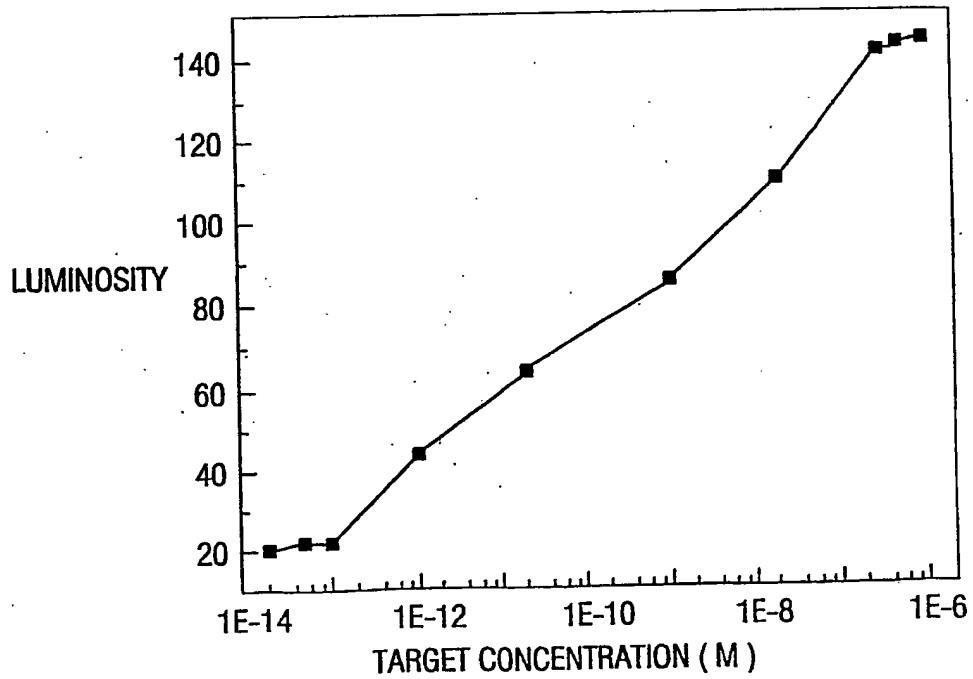

# FIG. 68

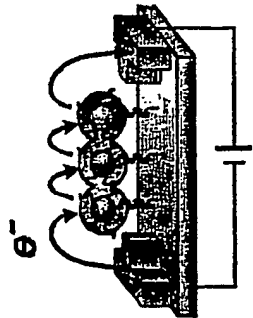

Ag<sup>+</sup>  
hydroquinone

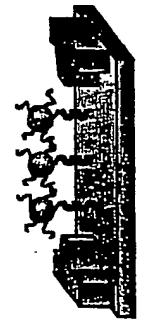

### A

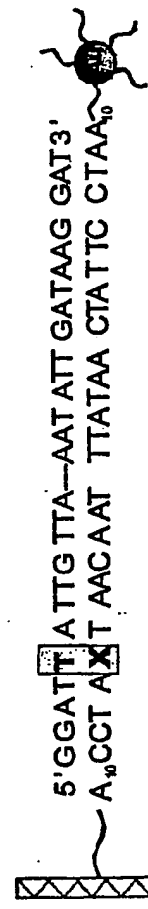

**X** = A (complementary),  
 T, G, C (mismatched)

### B

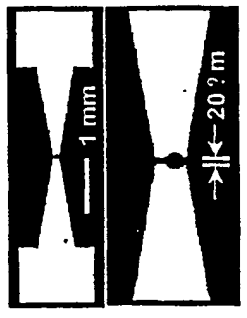

### C



FIG. 69A

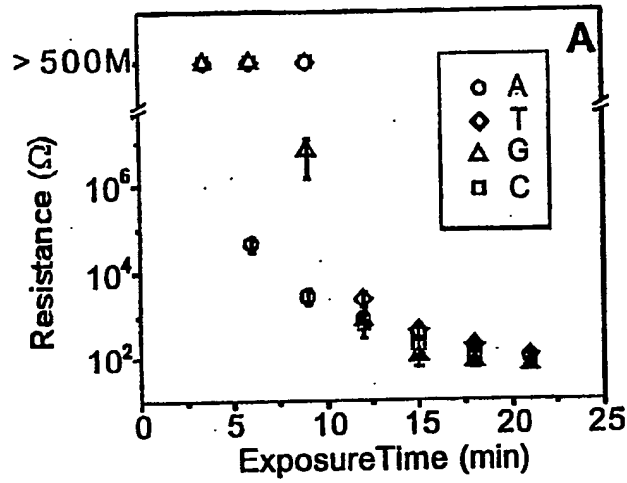

FIG. 69B

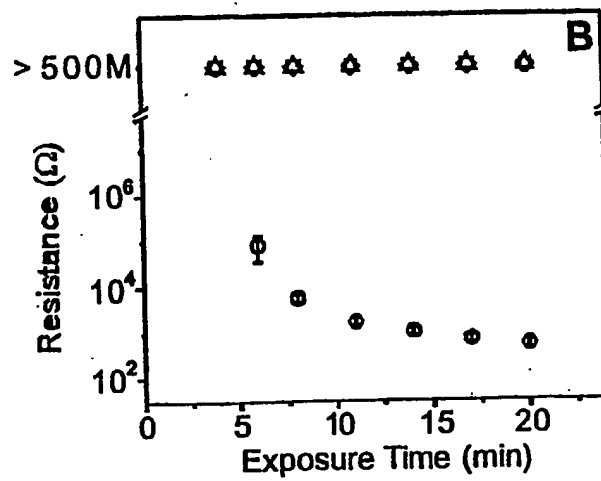

FIG. 69C

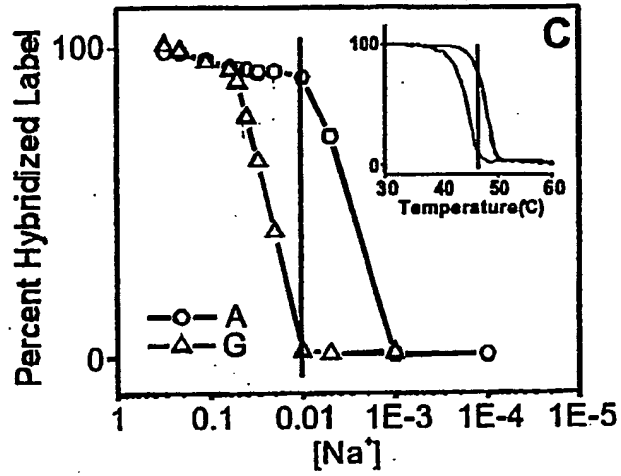

FIG. 69D

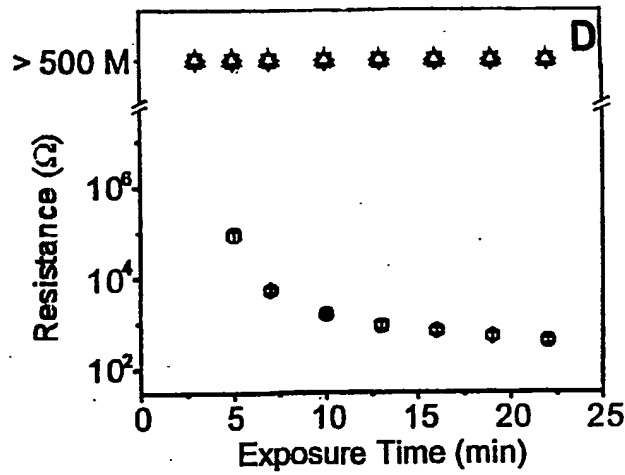

FIG. 70A

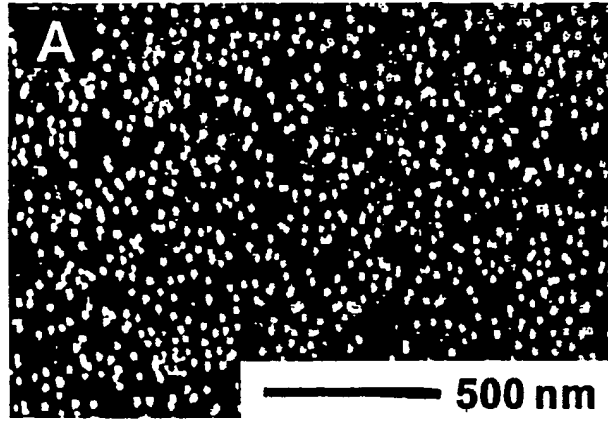
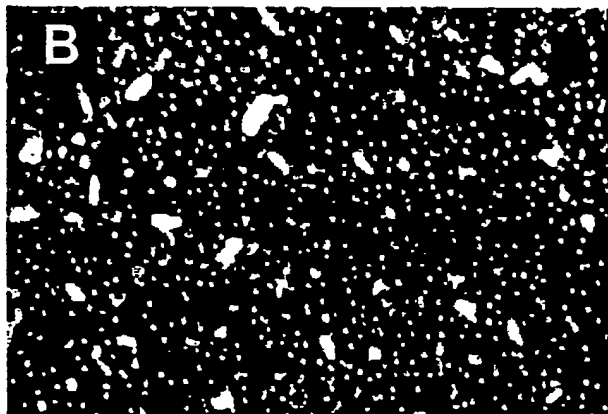
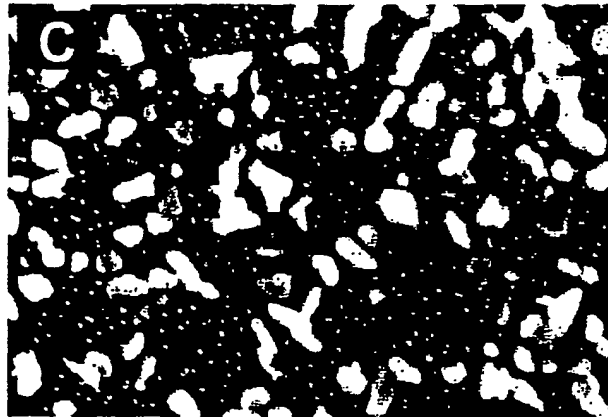

FIG. 70B



**FIG. 70C**



**FIG. 70D**

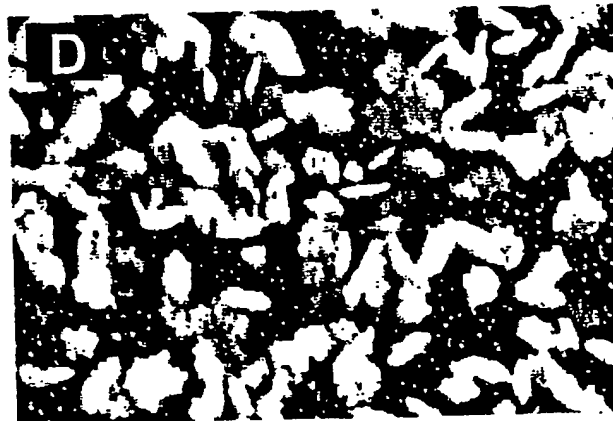
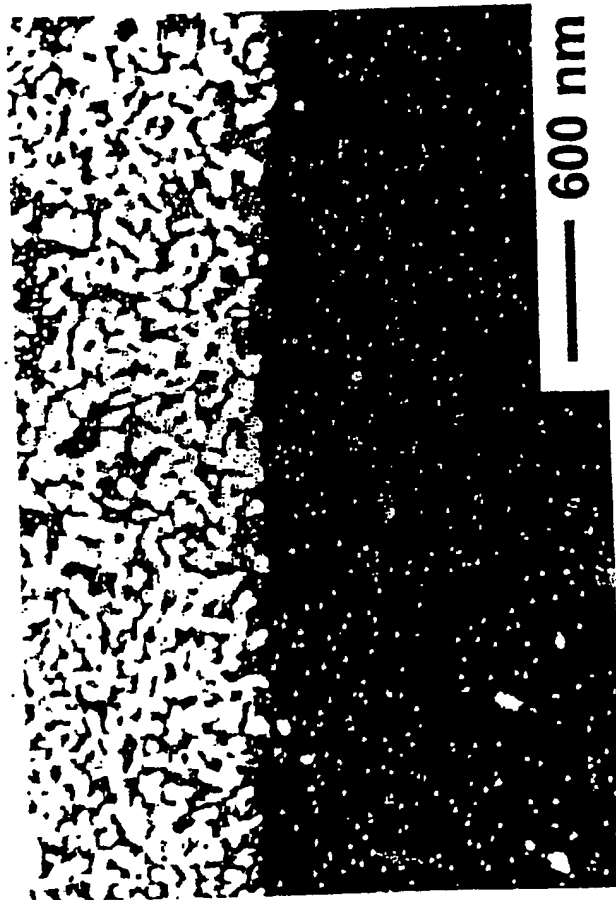

FIG. 71



01-1565-B seq list  
SEQUENCE LISTING

- <110> Nanosphere, Inc.  
Mirkin, Chad A.  
Letsinger, Robert L.  
Mucic, Robert C.  
Storhoff, James J.  
Elghanian, Robert  
Taton, Thomas A.  
Garimella, Viswanadham  
Li, Zhi  
Park, So-Jung  
Lu, Gang
- <120> NANOPARTICLES HAVING OLIGONUCLEOTIDES ATTACHED THERETO  
AND USES THEREFOR
- <130> 01-1565-B
- <140> 10/008,978  
<141> 2001-12-07
- <150> 09/927,777  
<151> 2001-08-10
- <150> 09/820,279  
<151> 2001-03-28
- <150> 09/760,500  
<151> 2001-01-12
- <150> 09/603,830  
<151> 2000-06-26
- <150> 09/344,667  
<151> 1999-06-25
- <150> 09/240,755  
<151> 1999-01-29
- <150> PCT/US97/12783  
<151> 1997-07-21
- <150> 60/031,809  
<151> 1996-07-29
- <150> 60/176,409  
<151> 2000-01-13
- <150> 60/192,699  
<151> 2000-03-28
- <150> 60/200,161  
<151> 2000-04-26
- <150> 60/213,906  
<151> 2000-06-26
- <150> 60/224,631  
<151> 2000-08-11
- <150> 60/254,392  
<151> 2000-12-08

## 01-1565-B seq list

<150> 60/254,418  
 <151> 2000-12-08

<150> 60/255,235  
 <151> 2000-12-11

<150> 60/255,236  
 <151> 2000-12-11

<150> 60/282,640  
 <151> 2001-04-09

<150> 60/327,864  
 <151> 2001-10-08

<160> 82

<170> Microsoft Word 2000

<210> 1

<211> 20

<212> DNA

<213> Artificial Sequence

<220>

<223> Description of Artificial Sequence:random  
 synthetic sequence

<400> 1

aaacgactct agcgcgtata

20

<210> 2

<211> 20

<212> DNA

<213> Artificial Sequence

<220>

<223> Description of Artificial Sequence:random  
 synthetic sequence

<400> 2

atggcaacta tacgcgctag

20

<210> 3

<211> 16

<212> DNA

<213> Artificial Sequence

<220>

<223> Description of Artificial Sequence:random  
 synthetic sequence

<400> 3

ccttgagatt tccctc

16

<210> 4

<211> 16

<212> DNA

## 01-1565-B seq list

<213> Artificial Sequence

<220>

<223> Description of Artificial Sequence:random synthetic sequence

<400> 4

gagggaaatc tcaagg

16

<210> 5

<211> 18

<212> DNA

<213> Artificial Sequence

<220>

<223> Description of Artificial Sequence:random synthetic sequence

<400> 5

aacttgcgct aatggcga

18

<210> 6

<211> 26

<212> DNA

<213> Artificial Sequence

<220>

<223> Description of Artificial Sequence:random synthetic sequence

<400> 6

aagttgcgct ttacggctaa tggcga

26

<210> 7

<211> 15

<212> DNA

<213> Artificial Sequence

<220>

<223> Description of Artificial Sequence:random synthetic sequence

<400> 7

tctccttccc ttttc

15

<210> 8

<211> 15

<212> DNA

<213> Artificial Sequence

<220>

<223> Description of Artificial Sequence:random synthetic sequence

<400> 8

gaaaagggaa ggaga

15

<210> 9



## 01-1565-B seq list

<211> 15  
 <212> DNA  
 <213> Artificial Sequence

<220>  
 <223> Description of Artificial Sequence:random  
 synthetic sequence

<400> 9  
 cttttccctt cctct

15

<210> 10  
 <211> 28  
 <212> DNA  
 <213> Artificial Sequence

<220>  
 <223> Description of Artificial Sequence:random  
 synthetic sequence

<400> 10  
 aaacgactct agcgcgtata gttgccat

28

<210> 11  
 <211> 28  
 <212> DNA  
 <213> Artificial Sequence

<220>  
 <223> Description of Artificial Sequence:random  
 synthetic sequence

<400> 11  
 atggcaacta tacgcgctag agtcgttt

28

<210> 12  
 <211> 15  
 <212> DNA  
 <213> Artificial Sequence

<220>  
 <223> Description of Artificial Sequence:random  
 synthetic sequence

<400> 12  
 cctatcgacc atgct

15

<210> 13  
 <211> 30  
 <212> DNA  
 <213> Artificial Sequence

<220>  
 <223> Description of Artificial Sequence:random  
 synthetic sequence

<400> 13  
 agcatggtcg ataggaaacg actctagcgc

30

## 01-1565-B seq list

<210> 14  
<211> 15  
<212> DNA  
<213> Artificial Sequence

<220>  
<223> Description of Artificial Sequence:random  
synthetic sequence

<400> 14  
gcgctagagt cgttt

<210> 15  
<211> 30  
<212> DNA  
<213> Artificial Sequence

<220>  
<223> Description of Artificial Sequence:random  
synthetic sequence

<400> 15  
agcatggtcg ataggatggc aactatacgc

<210> 16  
<211> 24  
<212> DNA  
<213> Artificial Sequence

<220>  
<223> Description of Artificial Sequence:random  
synthetic sequence

<400> 16  
gtc gatagga aacgactcta gcgc

<210> 17  
<211> 30  
<212> DNA  
<213> Artificial Sequence

<220>  
<223> Description of Artificial Sequence:random  
synthetic sequence

<400> 17  
agcatggttg ataggaaacg actctagcgc

<210> 18  
<211> 30  
<212> DNA  
<213> Artificial Sequence

<220>  
<223> Description of Artificial Sequence:random  
synthetic sequence

<400> 18

01-1565-B seq list  
agcatgtttg ataggaaacg actctagcgc 30

<210> 19  
<211> 12  
<212> DNA  
<213> Artificial Sequence

<220>  
<223> Description of Artificial Sequence:random  
synthetic sequence

<400> 19 12  
tctcaactcg ta

<210> 20  
<211> 12  
<212> DNA  
<213> Artificial Sequence

<220>  
<223> Description of Artificial Sequence:random  
synthetic sequence

<400> 20 12  
cgcattcagg at

<210> 21  
<211> 24  
<212> DNA  
<213> Artificial Sequence

<220>  
<223> Description of Artificial Sequence:random  
synthetic sequence

<400> 21 24  
tacgagttga gagagtgcc acat

<210> 22  
<211> 24  
<212> DNA  
<213> Artificial Sequence

<220>  
<223> Description of Artificial Sequence:random  
synthetic sequence

<400> 22 24  
tacgagttga gaatcctgaa tgcg

<210> 23  
<211> 24  
<212> DNA  
<213> Artificial Sequence

<220>  
<223> Description of Artificial Sequence:random  
synthetic sequence

## 01-1565-B seq list

<400> 23  
tacgagttga gaatcctgaa tgct 24

<210> 24  
<211> 24  
<212> DNA  
<213> Artificial Sequence

<220>  
<223> Description of Artificial Sequence:random  
synthetic sequence

<400> 24  
tacgagttga gactcctgaa tgcg 24

<210> 25  
<211> 23  
<212> DNA  
<213> Artificial Sequence

<220>  
<223> Description of Artificial Sequence:random  
synthetic sequence

<400> 25  
tacgagttga gaatcctgaa tgc 23

<210> 26  
<211> 25  
<212> DNA  
<213> Artificial Sequence

<220>  
<223> Description of Artificial Sequence:random  
synthetic sequence

<400> 26  
tacgagttga gacatcctga atgcg 25

<210> 27  
<211> 24  
<212> DNA  
<213> Artificial Sequence

<220>  
<223> Description of Artificial Sequence:random  
synthetic sequence

<400> 27  
tacgagttga gaatcctgaa tgcg 24

<210> 28  
<211> 12  
<212> DNA  
<213> Artificial Sequence

<220>

01-1565-B seq list

<223> Description of Artificial Sequence:random  
synthetic sequence

<400> 28  
taggacttac gc 12

<210> 29  
<211> 48  
<212> DNA  
<213> Artificial Sequence

<220>  
<223> Description of Artificial Sequence:random  
synthetic sequence

<400> 29  
tacgagttga gaccgttaag acgaggcaat catgcaatcc tgaatgcg 48

<210> 30  
<211> 24  
<212> DNA  
<213> Artificial Sequence

<220>  
<223> Description of Artificial Sequence:random  
synthetic sequence

<400> 30  
tgcgatgattg cctcgtctta acgg 24

<210> 31  
<211> 72  
<212> DNA  
<213> Artificial Sequence

<220>  
<223> Description of Artificial Sequence:random  
synthetic sequence

<400> 31  
tacgagttga gaccgttaag acgaggcaat catgcatata ttggacgctt tacggacaac 60  
atcctgaatg cg 72

<210> 32  
<211> 48  
<212> DNA  
<213> Artificial Sequence

<220>  
<223> Description of Artificial Sequence:random  
synthetic sequence

<400> 32  
gttgccgta aagcgtcaa tatatgcatg attgcctcgt ctaacgg 48

<210> 33  
<211> 12  
<212> DNA

## 01-1565-B seq list

<213> Artificial Sequence

<220>

<223> Description of Artificial Sequence:random synthetic sequence

<400> 33

tctcaactcg ta

12

<210> 34

<211> 24

<212> DNA

<213> Artificial Sequence

<220>

<223> Description of Artificial Sequence:random synthetic sequence

<400> 34

tacgagttga gaatcctgaa tgcg

24

<210> 35

<211> 12

<212> DNA

<213> Artificial Sequence

<220>

<223> Description of Artificial Sequence:random synthetic sequence

<400> 35

cgcattcagg at

12

<210> 36

<211> 141

<212> DNA

<213> anthrax

<400> 36

ggcggatgag tcagtagtta aggaggctca tagagaagta attaattcgt caacagaggg 60  
attattgtta aatattgata aggatataag aaaaatatta tccagggtta tattgtagaa 120  
attgaagata ctgaagggt t 141

<210> 37

<211> 15

<212> DNA

<213> Artificial Sequence

<220>

<223> Description of Artificial Sequence:random synthetic sequence

<400> 37

taacaataat ccctc

15

<210> 38

<211> 15

<212> DNA

## 01-1565-B seq list

<213> Artificial Sequence

<220>  
<223> Description of Artificial Sequence:random synthetic sequence

<400> 38  
atccttatca atatt 15

<210> 39  
<211> 30  
<212> DNA  
<213> Artificial Sequence

<220>  
<223> Description of Artificial Sequence:random synthetic sequence

<400> 39  
tgagcctcct taactactga ctcatccgcc 30

<210> 40  
<211> 25  
<212> DNA  
<213> Artificial Sequence

<220>  
<223> Description of Artificial Sequence:random synthetic sequence

<400> 40  
tgttgacgaa ttaattactt ctcta 25

<210> 41  
<211> 27  
<212> DNA  
<213> Artificial Sequence

<220>  
<223> Description of Artificial Sequence:random synthetic sequence

<400> 41  
tataaccctg gataatattt ttcttat 27

<210> 42  
<211> 29  
<212> DNA  
<213> Artificial Sequence

<220>  
<223> Description of Artificial Sequence:random synthetic sequence

<400> 42  
aagcccttca gtatcttcaa tttctacaa 29

<210> 43

## 01-1565-B seq list

<211> 22  
<212> DNA  
<213> Artificial Sequence

<220>  
<223> Description of Artificial Sequence:random  
synthetic sequence

<400> 43  
tctcaactcg taaaaaaaaa aa 22

<210> 44  
<211> 24  
<212> DNA  
<213> Artificial Sequence

<220>  
<223> Description of Artificial Sequence:random  
synthetic sequence

<400> 44  
tacgagttga gaatcctgaa tgcg 24

<210> 45  
<211> 22  
<212> DNA  
<213> Artificial Sequence

<220>  
<223> Description of Artificial Sequence:random  
synthetic sequence

<400> 45  
aaaaaaaaaa cgattcagg at 22

<210> 46  
<211> 22  
<212> DNA  
<213> Artificial Sequence

<220>  
<223> Description of Artificial Sequence:random  
synthetic sequence

<400> 46  
tctcaactcg taaaaaaaaa aa 22

<210> 47  
<211> 22  
<212> DNA  
<213> Artificial Sequence

<220>  
<223> Description of Artificial Sequence:random  
synthetic sequence

<400> 47  
aaaaaaaaaa cgattcagg at 22



01-1565-B seq list

<210> 48  
 <211> 24  
 <212> DNA  
 <213> Artificial Sequence

<220>  
 <223> Description of Artificial Sequence:random  
 synthetic sequence

<400> 48  
 tacgagttga gaatcctgaa tgcg 24

<210> 49  
 <211> 24  
 <212> DNA  
 <213> Artificial Sequence

<220>  
 <223> Description of Artificial Sequence:random  
 synthetic sequence

<400> 49  
 ctacttagat ccgagtgccc acat 24

<210> 50  
 <211> 12  
 <212> DNA  
 <213> Artificial Sequence

<220>  
 <223> Description of Artificial Sequence:random  
 synthetic sequence

<400> 50  
 cgcattcagg at 12

<210> 51  
 <211> 32  
 <212> DNA  
 <213> Artificial Sequence

<220>  
 <223> Description of Artificial Sequence:random  
 synthetic sequence

<400> 51  
 aaaaaaaaaa aaaaaaaaaa cgcattcagg at 32

<210> 52  
 <211> 32  
 <212> DNA  
 <213> Artificial Sequence

<220>  
 <223> Description of Artificial Sequence:random  
 synthetic sequence

<400> 52

01-1565-B seq list  
 cgcattcagg atwwwwwwww wwwwwwwwww ww 32

<210> 53  
 <211> 12  
 <212> DNA  
 <213> Artificial Sequence

<220>  
 <223> Description of Artificial Sequence:random  
 synthetic sequence

<400> 53  
 atcctgaatg cg 12

<210> 54  
 <211> 12  
 <212> DNA  
 <213> Artificial Sequence

<220>  
 <223> Description of Artificial Sequence:random  
 synthetic sequence

<400> 54  
 atcctgaatg cg 12

<210> 55  
 <211> 20  
 <212> DNA  
 <213> Artificial Sequence

<220>  
 <223> Description of Artificial Sequence:random  
 synthetic sequence

<400> 55  
 aaaaaaaaaa aaaaaaaaaa 20

<210> 56  
 <211> 27  
 <212> DNA  
 <213> Anthrax

<400> 56  
 ggattattgt taattattga taaggat 27

<210> 57  
 <211> 12  
 <212> DNA  
 <213> Anthrax

<220>  
 <221> misc\_feature  
 <222> (8)..(8)  
 <223> n stands for a, g, c, or t

<400> 57  
 taacaatnat cc 12

01-1565-B seq list

<210> 58  
 <211> 15  
 <212> DNA  
 <213> Anthrax  
  
 <400> 58  
 atccttatca atatt 15  
  
 <210> 59  
 <211> 12  
 <212> DNA  
 <213> Artificial Sequence  
  
 <220>  
 <223> Description of Artificial Sequence:random  
 synthetic sequence  
  
 <400> 59  
 tctcaactcg ta 12  
  
 <210> 60  
 <211> 24  
 <212> DNA  
 <213> Artificial Sequence  
  
 <220>  
 <223> Description of Artificial Sequence:random  
 synthetic sequence  
  
 <400> 60  
 tacgagttga gaatcctgaa tgcg 24  
  
 <210> 61  
 <211> 48  
 <212> DNA  
 <213> Artificial Sequence  
  
 <220>  
 <223> Description of Artificial Sequence:random  
 synthetic sequence  
  
 <400> 61  
 gcgtaagtcc taacgtacta acggagcaga attgccagag ttgagcat 48  
  
 <210> 62  
 <211> 72  
 <212> DNA  
 <213> Artificial Sequence  
  
 <220>  
 <223> Description of Artificial Sequence:random  
 synthetic sequence  
  
 <400> 62  
 gcgtaagtcc tacaacaggc atttcgcagg ttatatacgt actaacggag cagaattgcc 60  
 agagttgagc at 72

## 01-1565-B seq list

<210> 63  
 <211> 24  
 <212> DNA  
 <213> Artificial Sequence  
  
 <220>  
 <223> Description of Artificial Sequence:random  
 synthetic sequence  
  
 <400> 63  
 tgcattgattg cctcgtctta acgg 24  
  
 <210> 64  
 <211> 48  
 <212> DNA  
 <213> Artificial Sequence  
  
 <220>  
 <223> Description of Artificial Sequence:random  
 synthetic sequence  
  
 <400> 64  
 gttgtccgta aagcgtccaa tatatgcatg attgcctcgt cttaacgg 48  
  
 <210> 65  
 <211> 16  
 <212> DNA  
 <213> Artificial Sequence  
  
 <220>  
 <223> Description of Artificial Sequence:random  
 synthetic sequence  
  
 <400> 65  
 tatcgttcca tcagct 16  
  
 <210> 66  
 <211> 15  
 <212> DNA  
 <213> Artificial Sequence  
  
 <220>  
 <223> Description of Artificial Sequence:random  
 synthetic sequence  
  
 <400> 66  
 ttgatcttcc gttct 15  
  
 <210> 67  
 <211> 34  
 <212> DNA  
 <213> Artificial Sequence  
  
 <220>  
 <223> Description of Artificial Sequence:random  
 synthetic sequence  
  
 <400> 67  
 agaacggaaa gatcaacgag ctgatggaac gata 34

## 01-1565-B seq list

<210> 68  
 <211> 30  
 <212> DNA  
 <213> Artificial Sequence  
  
 <220>  
 <223> Description of Artificial Sequence:random  
 synthetic sequence  
  
 <400> 68  
 aaaaaaaaaa aaaaaaaaaa gcagacctca 30  
  
 <210> 69  
 <211> 31  
 <212> DNA  
 <213> Artificial Sequence  
  
 <220>  
 <223> Description of Artificial Sequence:random  
 synthetic sequence  
  
 <400> 69  
 aaaaaaaaaa aaaaaaaaaa cctatgtgtc g' 31  
  
 <210> 70  
 <211> 20  
 <212> DNA  
 <213> Artificial Sequence  
  
 <220>  
 <223> Description of Artificial Sequence:random  
 synthetic sequence  
  
 <400> 70  
 aaaaaaaaaa aaaaaaaaaa 20  
  
 <210> 71  
 <211> 21  
 <212> DNA  
 <213> Artificial Sequence  
  
 <220>  
 <223> Description of Artificial Sequence:random  
 synthetic sequence  
  
 <400> 71  
 cgacacatag gtgaggctctg c 21  
  
 <210> 72  
 <211> 35  
 <212> DNA  
 <213> Artificial Sequence  
  
 <220>  
 <223> Description of Artificial Sequence:random  
 synthetic sequence  
  
 <400> 72  
 aaaaaaaaaa aaaaaaaaaa atccttatca atatt 35  
  
 <210> 73  
 <211> 22  
 <212> DNA

01-1565-B seq list

<213> Artificial Sequence

<220>

<223> Description of Artificial Sequence:random synthetic sequence

<400> 73  
tctcaactcg taaaaaaaa aa 22

<210> 74  
<211> 22  
<212> DNA  
<213> Artificial Sequence

<220>

<223> Description of Artificial Sequence:random synthetic sequence

<400> 74  
aaaaaaaaaa cgcattcagg at 22

<210> 75  
<211> 22  
<212> DNA  
<213> Artificial Sequence

<220>

<223> Description of Artificial Sequence:random synthetic sequence

<400> 75  
aaaaaaaaaa cgcattcagg at 22

<210> 76  
<211> 24  
<212> DNA  
<213> Artificial Sequence

<220>

<223> Description of Artificial Sequence:random synthetic sequence

<400> 76  
tacgagttga gaatcctgat tgcg 24

<210> 77  
<211> 35  
<212> DNA  
<213> Artificial Sequence

<220>

<223> Description of Artificial Sequence:random synthetic sequence

<400> 7  
aaaaaaaaaa aaaaaaaaa atccttatca atatt 35

<210> 78  
<211> 35  
<212> DNA  
<213> Artificial Sequence

<220>

01-1565-B seq list

<223> Description of Artificial Sequence:random  
synthetic sequence

<400> 78  
aaaaaaaaa aaaaaaaaaa taacaataat ccctc 35

<210> 79  
<211> 35  
<212> DNA  
<213> Artificial Sequence

<220>  
<223> Description of Artificial Sequence:random  
synthetic sequence

<400> 79  
taatcctt cttataaaa aaaaaaaaaa aaaa 35

<210> 80  
<211> 35  
<212> DNA  
<213> Artificial Sequence

<220>  
<223> Description of Artificial Sequence:random  
synthetic sequence

<400> 80  
ctacaatata accctaaaa aaaaaaaaaa aaaa 35

<210> 81  
<211> 30  
<212> DNA  
<213> Artificial Sequence

<220>  
<223> Description of Artificial Sequence:random  
synthetic sequence

<400> 81  
ataagaagga tattaatat tgataaggat 30

<210> 82  
<211> 30  
<212> DNA  
<213> Artificial Sequence

<220>  
<223> Description of Artificial Sequence:random  
synthetic sequence

<400> 82  
agggttatat tgtaggaggg attattgta 30

**This Page is Inserted by IFW Indexing and Scanning  
Operations and is not part of the Official Record**

**BEST AVAILABLE IMAGES**

Defective images within this document are accurate representations of the original documents submitted by the applicant.

Defects in the images include but are not limited to the items checked:

- BLACK BORDERS
- IMAGE CUT OFF AT TOP, BOTTOM OR SIDES
- FADED TEXT OR DRAWING
- BLURRED OR ILLEGIBLE TEXT OR DRAWING
- SKEWED/SLANTED IMAGES
- COLOR OR BLACK AND WHITE PHOTOGRAPHS
- GRAY SCALE DOCUMENTS
- LINES OR MARKS ON ORIGINAL DOCUMENT
- REFERENCE(S) OR EXHIBIT(S) SUBMITTED ARE POOR QUALITY
- OTHER: \_\_\_\_\_

**IMAGES ARE BEST AVAILABLE COPY.**

**As rescanning these documents will not correct the image problems checked, please do not report these problems to the IFW Image Problem Mailbox.**